



**NEC's POWER AMPLIFIER
FOR BLUETOOTH™ CLASS 1**

UPG2301TQ

FEATURES

- **OPERATION FREQUENCY**
f_{opt} = 2,400 to 2,500 MHz (2 450 MHz TYP.)
- **SUPPLY VOLTAGE**
V_{CC1,2} = V_{bias} = 2.7 to 3.6 V (3.3 V TYP.)
- **CONTROL VOLTAGE**
V_{cont} = 0 to 3.6 V (2.5 V TYP.)
V_{enable} = 0 to 3.1 V (2.9 V TYP.)
- **CIRCUIT CURRENT**
I_{CC} = 120 mA TYP. @ V_{CC1,2} = V_{bias} = 3.3 V, V_{cont} = 2.5 V,
V_{enable} = 2.9 V, P_{in} = +4 dBm
- **MAXIMUM POWER**
P_{out(MAX.)} = +23 dBm TYP. @ V_{CC1,2} = V_{bias} = 3.3 V,
V_{cont} = 2.5 V, V_{enable} = 2.9 V, P_{in} = +4 dBm
- **GAIN CONTROL RANGE**
GCR = 23 dB TYP. @ V_{CC1,2} = V_{bias} = 3.3 V,
V_{cont} = 0 to 2.5 V, V_{enable} = 2.9 V, P_{in} = +4 dBm
- **POWER GAIN**
G_P = 23 dB TYP. (Reference value)
- **HIGH EFFICIENCY**
PAE = 50% TYP. (Reference value)
- **SHUT DOWN FUNCTION**
- **HIGH-DENSITY SURFACE MOUNTING**
10 pin plastic TSON package (2.4 × 2.55 × 0.6 mm)

DESCRIPTION

NEC's μPG2301TQ is a GaAs HBT MMIC for power amplifier for Bluetooth Class 1.

This device realizes high efficiency, high gain and high output power by using InGaP HBT. This device is housed in a low profile 10-pin plastic TSON package.

APPLICATION

- **POWER AMPLIFIER FOR BLUETOOTH CLASS 1**
- **WIRELESS LAN**

ELECTRICAL CHARACTERISTICS

(Unless otherwise specified, T_A = +25°C, V_{CC1,2} = V_{bias} = 3.3 V, f = 2,450 MHz, External input and output matching)

PARAMETER	SYMBOL	TEST CONDITIONS	MIN.	TYP.	MAX.	UNIT
Circuit Current	I _{CC}	V _{cont} = 2.5 V, V _{enable} = 2.9 V, P _{in} = +4 dBm	110	120	130	mA
Shut Down Current	I _{shut down}	V _{cont} = 2.5 V, V _{enable} = 0 V, P _{in} = +4 dBm	-	0.1	1.0	μA
Output Power 1	P _{out1}	V _{cont} = 2.5 V, V _{enable} = 2.9 V, P _{in} = +4 dBm	+21	+23	+24.5	dBm
Output Power 2	P _{out2}	V _{cont} = 0 V, V _{enable} = 2.9 V, P _{in} = +4 dBm	-	0	+1	dBm
Gain Control Range	GCR	V _{cont} = 0 to 2.5 V, V _{enable} = 2.9 V, P _{in} = +4 dBm	20	23	-	dB

ELECTRICAL CHARACTERISTICS

(Unless otherwise specified, T_A = +25°C, V_{CC1,2} = V_{bias} = 3.3 V, f = 2,450 MHz, External input and output matching)

PARAMETER	SYMBOL	TEST CONDITIONS	MIN.	TYP.	MAX.	UNIT
Efficiency	PAE	V _{cont} = 2.5 V, V _{enable} = 2.9 V, P _{in} = +4 dBm	-	50	-	%
Power Gain	G _P	V _{cont} = 2.5 V, V _{enable} = 2.9 V, P _{in} = -5 dBm	-	23	-	dB

ABSOLUTE MAXIMUM RATINGS

PARAMETER	SYMBOL	RATINGS	UNIT
Supply Voltage	$V_{CC1,2}$	5.0	V
	V_{bias}		
Control Voltage	V_{cont}	3.6	V
	V_{enable}		
Circuit Current	I_{cc}	400	mA
Control Current	I_{cont}	0.5	mA
	I_{enable}		
Power Dissipation	P_D	700 ^{Note}	mW
Operating Ambient Temperature	T_A	-40 to +85	°C
Storage Temperature	T_{stg}	-55 to +150	°C
Input Power	P_{in}	+10	dBm

Note Mounted on double copper-clad 50 × 50 × 1.6 mm epoxy glass PWB, $T_A = +85^\circ\text{C}$

RECOMMENDED OPERATING RANGE

($T_A = +25^\circ\text{C}$)

PARAMETER	SYMBOL	MIN.	TYP.	MAX.	UNIT
Operating Frequency	f_{opt}	2,400	2,450	2,500	MHz
Supply Voltage	$V_{CC1,2}$	2.7	3.3	3.6	V
	V_{bias}				
Control Voltage	V_{cont}	0	2.5	3.6	V
	V_{enable}	0	2.9	3.1	

PIN CONNECTIONS AND INTERNAL BLOCK DIAGRAM

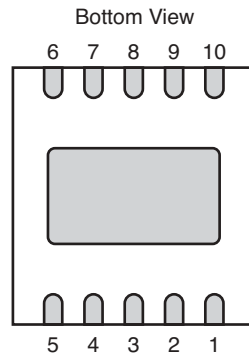
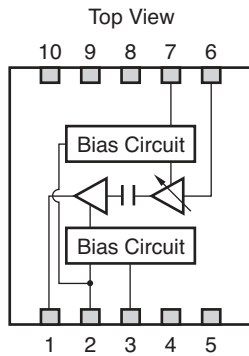
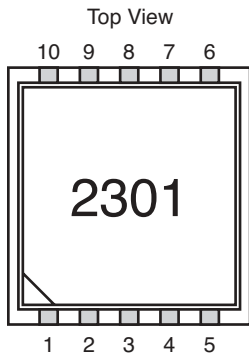

PIN NO.	PIN NAME
1	OUTPUT/ V_{CC2}
2	V_{enable}
3	V_{bias}
4	GND
5	V_{CC1}
6	INPUT
7	V_{cont}
8	N.C.
9	GND
10	GND

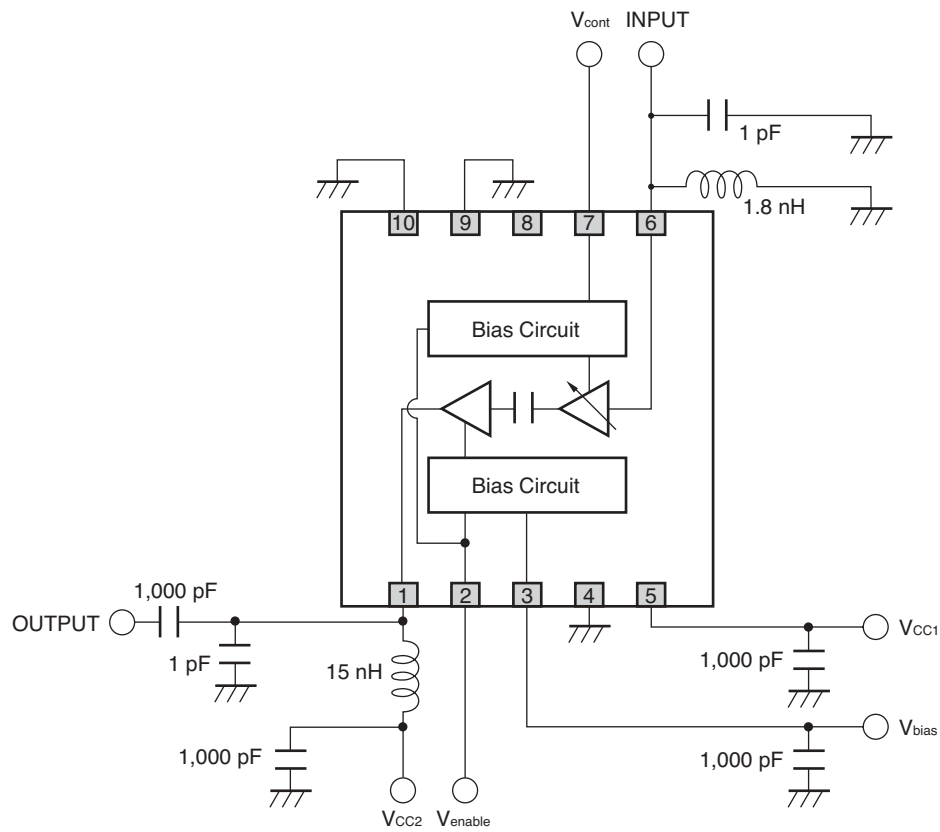
EVALUATION CIRCUIT ($V_{CC1,2} = V_{bias} = 3.3\text{ V}$, $f = 2,450\text{ MHz}$)

The application circuits and their parameters are for reference only and are not intended for use in actual design-ins.

ILLUSTRATION OF THE TEST CIRCUIT ASSEMBLED ON EVALUATION BOARD

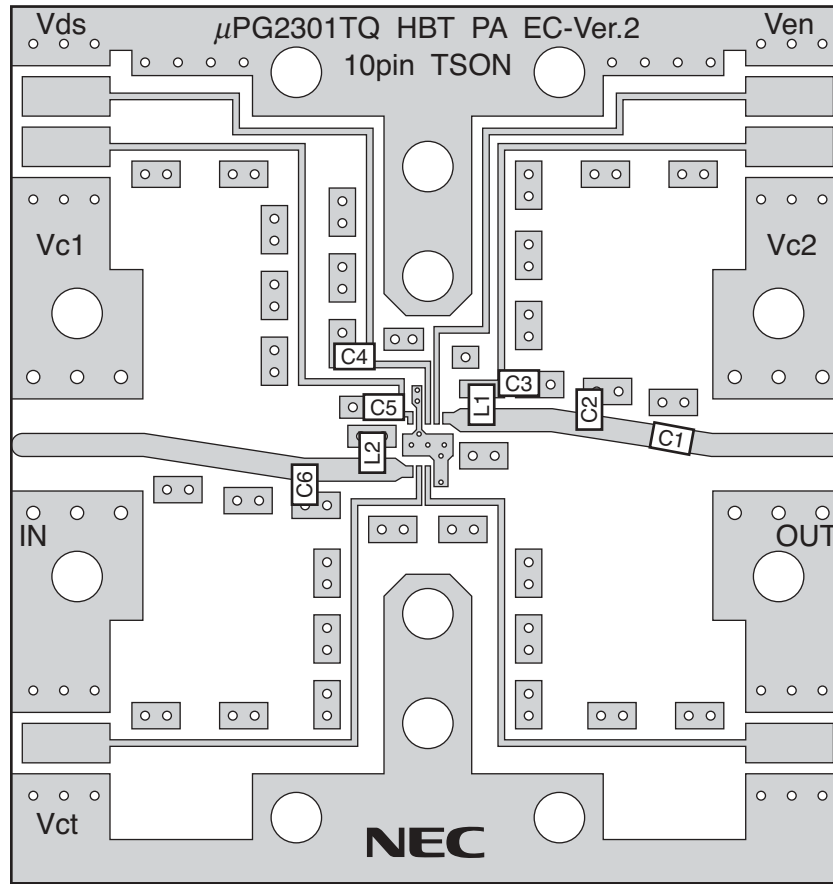

COMPONENT LIST

SYMBOL	RATING	PART NUMBER	MANUFACTURER
C1, C3, C4, C5	1,000 pF	GRM39CH102J50	muRata
C2, C6	1 pF	GRM39CH010C50	muRata
L1	15 nH	TFL0816-15N	Susumu
L2	1.8 nH	TFL0816-1N8	Susumu

TYPICAL CHARACTERISTICS

Condition : $f = 2,450 \text{ MHz}$, $V_{CC1} = V_{CC2} = V_{bias} = 3.3 \text{ V}$, $V_{enable} = 2.9 \text{ V}$, $P_{in} = +4 \text{ dBm}$, External input and output matching

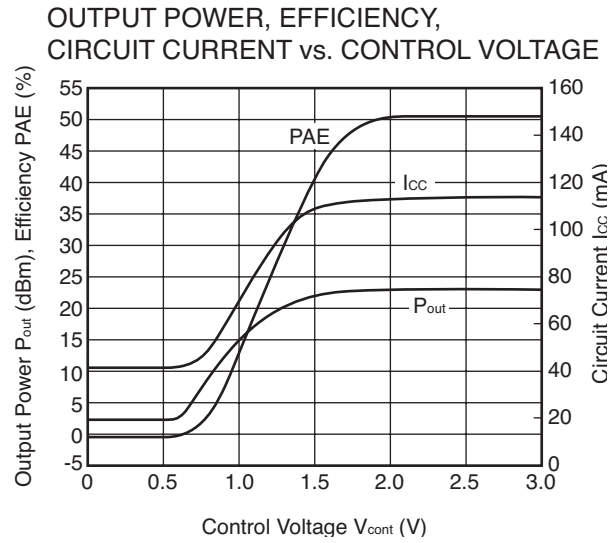

Condition : $f = 2,450 \text{ MHz}$, $V_{CC1} = V_{CC2} = V_{bias} = 3.3 \text{ V}$, $V_{enable} = 2.9 \text{ V}$, $V_{cont} = 2.5 \text{ V}$, External input and output matching

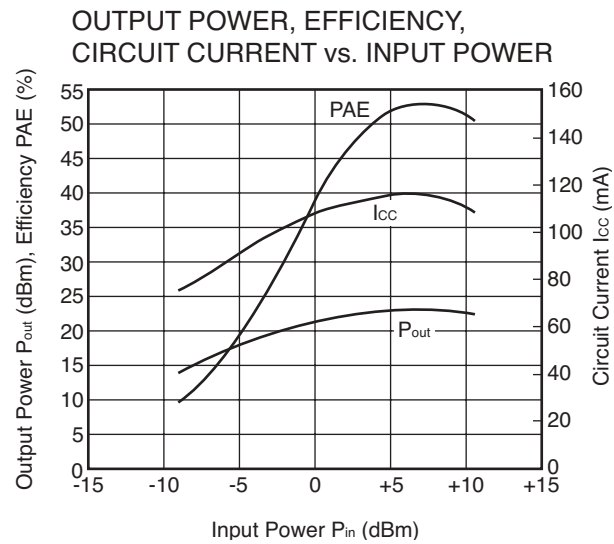

Remark The graphs indicate nominal characteristics.

PACKAGE DIMENSIONS

10-PIN PLASTIC TSON (UNIT: mm)

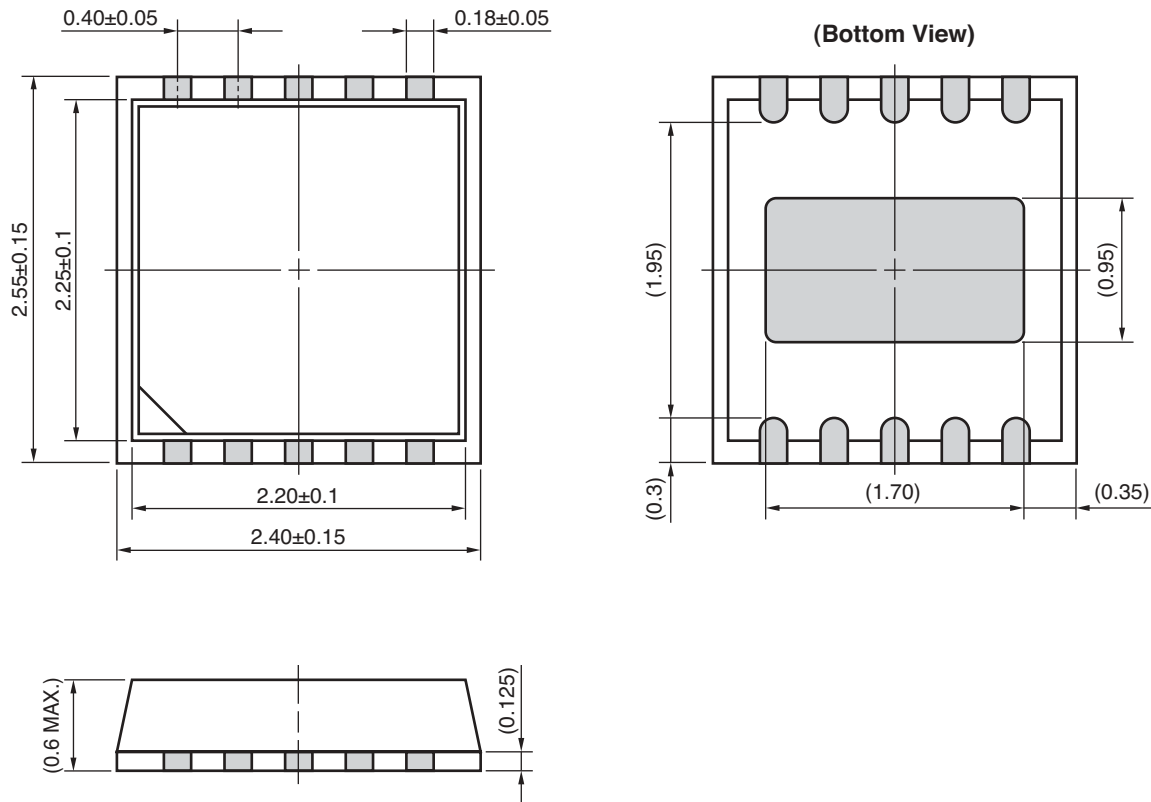

Note () : Reference value

ORDERING INFORMATION

PART NUMBER	PACKAGE	MARKING	SUPPLYING FORM
μPG2301TQ-E1	10-pin plastic TSON	2301	<ul style="list-style-type: none"> • Embossed tape 8 mm wide • Pin 5, 6 face the perforation side of the tape • Qty 3 kpcs/reel

Remark To order evaluation samples, contact your nearby sales office.
 Part number for sample order: μPG2301TQ

Life Support Applications

These NEC products are not intended for use in life support devices, appliances, or systems where the malfunction of these products can reasonably be expected to result in personal injury. The customers of CEL using or selling these products for use in such applications do so at their own risk and agree to fully indemnify CEL for all damages resulting from such improper use or sale.

CEL California Eastern Laboratories, Your source for NEC RF, Microwave, Optoelectronic, and Fiber Optic Semiconductor Devices.
 4590 Patrick Henry Drive • Santa Clara, CA 95054-1817 • (408) 988-3500 • FAX (408) 988-0279 • www.cel.com

DATA SUBJECT TO CHANGE WITHOUT NOTICE

02/04/2004