

AXL E IOL RTD1 M12 S

Axioline E IO-Link/analog converter for connecting an RTD, straight version

Data sheet
8597_en_07

© PHOENIX CONTACT 2015-04-28



1 Description

The IO-Link/analog converter is an IO-Link slave that converts analog signals into the IO-Link protocol.

It therefore offers the option of acquiring the signals of analog sensors via an IO-Link master.

Features

- Straight version
- 1 IO-Link interface
- 1 analog input for connecting resistance temperature detectors (RTDs)
- Connection of the sensor in 3-wire technology
- IO-Link and sensor connections via M12 connectors
- FE connection for local connection to functional earth ground
- Supply of the module electronics and the sensor via the IO-Link interface of the IO-Link master
- Diagnostic indicator



Make sure you always use the latest documentation.
It can be downloaded from the product at phoenixcontact.net/products.

2	Table of contents	
1	Description	1
2	Table of contents	2
3	Ordering data	3
4	Technical data	3
5	Additional tables	5
6	Internal circuit diagram	5
7	Pin assignment	6
	7.1 Connections on the device	6
	7.2 Pin assignment of the IO-Link interface	6
	7.3 Pin assignment of the analog input	6
8	Connection notes	6
9	Connection example	6
10	Assembly	7
11	Local status indicator	7
12	Process data	8
	12.1 IN process data	8
	12.2 OUT process data	8
	12.3 Parameterization via OUT process data	9
	12.4 Example	9
13	Significant values in various formats	10
	13.1 IB IL format	10
	13.2 IB IL format	10
	13.3 S7-compatible format	10
14	IO-Link objects	11
	14.1 Overview of the objects	11
	14.2 Parameterization (80 _{hex} : ParaWord)	12

3 Ordering data

Description	Type	Order No.	Pcs. / Pkt.
Axioline E-IO-Link/analog converter for connecting a temperature measurement resistor, M12 fast connection technology, straight version	AXL E IOL RTD1 M12 S	2700352	1

4 Technical data

Dimensions (nominal sizes in mm)

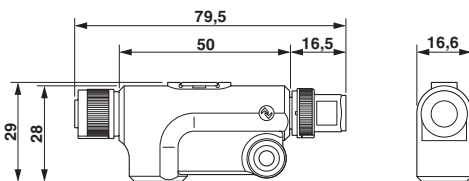

Width	16.6 mm
Height	29 mm
Depth	79.5 mm

General data

Weight	34 g
Ambient temperature (operation)	-25 °C ... 60 °C
Ambient temperature (storage/transport)	-25 °C ... 85 °C
Permissible humidity (operation)	5 % ... 95 %
Permissible humidity (storage/transport)	5 % ... 95 %
Air pressure (operation)	70 kPa ... 106 kPa (up to 3000 m above sea level)
Air pressure (storage/transport)	70 kPa ... 106 kPa (up to 3000 m above sea level)
Degree of protection	IP65/67
Protection class	III, IEC 61140, EN 61140, VDE 0140-1
Pollution degree	2

IO-Link

Specification	V1.1.1
Protection against polarity reversal	Yes
Transmission speed	230,4 kBit/s (COM3)
Frame type	1
Cycle Time	min. 2 ms
Process data update	2 ms
Amount of process data	16 Bit (Input data)

IO-Link ports

Number of ports	1
Connection method	M12 connector, A-coded

IO-Link port supply

Typical current consumption	16.5 mA \pm 15% (at 24 V DC)
Current consumption	max. 25 mA
Protection against polarity reversal	Yes
Short-circuit protection	Yes
Overload protection	Yes
I/O supply voltage	24 V DC This supply voltage is provided via the IO-Link interface of the IO-Link master.

Analog RTD inputs

Number of inputs	1 (for resistance temperature detectors)
Connection method	M12 connector, A-coded
Connection method	3-wire (optionally 4-wire)
Sensor types (RTD) that can be used	Pt 100, Pt 1000
Linear resistance measuring range	IB IL format: 0 Ω ... 500 Ω , 0 Ω ... 5 k Ω S7-compatible format: 0 Ω ... 600 Ω , 0 Ω ... 6 k Ω
Resolution A/D	12 bit
Data formats	IB IL, S7-compatible
Relative accuracy	< 0.3 % (From the measuring range final value in the nominal range)
Permissible cable length	max. 30 m (Shielded cable)
Protection against polarity reversal	yes
Short-circuit protection	yes
Overload protection	yes

Error messages to the higher level control or computer system

Overrange or underrange	Message in the diagnostic code (in the IB IL format)
Measured value invalid/no valid measured value present	Message in the diagnostic code (in the IB IL format)
Configuration invalid	Message in the diagnostic code (in the IB IL format)
Module faulty	Message in the diagnostic code (in the IB IL format)

Mechanical tests

Vibration resistance in acc. with EN 60068-2-6/IEC 60068-2-6	Operation: 2g
Vibration resistance in acc. with EN 60068-2-6/IEC 60068-2-6	Storage/transport: 5g
Shock in acc. with EN 60068-2-27/IEC 60068-2-27	Operation: 30g, 11 ms, three shocks in each space direction
Shock in acc. with EN 60068-2-27/IEC 60068-2-27	Storage/transport: 50g, 11 ms, three shocks in each space direction
Continuous shock according to EN 60068-2-27/IEC 60068-2-27	10g, 16 ms, 1000 shocks, in all space directions

Approvals

For the latest approvals, please visit phoenixcontact.net/products.

5 Additional tables

The data is valid for nominal operation (supply voltage = 24 V) in the default configuration.

Tolerance and temperature response at $T_A = -25^\circ\text{C}$ to $+60^\circ\text{C}$				
Sensor type	Measuring range		Drift	
	Lower limit	Upper limit	Typical	Maximum
Pt 100 DIN	-200 °C	+850 °C	±5 ppm/K	±95 ppm/K
Pt 1000 SAMA	-200 °C	+850 °C	±20 ppm/K	±95 ppm/K
Linear resistor R_{Lin} 500 Ω (linear range 1)	0 Ω	500 Ω	±5 ppm/K	±95 ppm/K
Linear resistor R_{Lin} 5000 Ω (linear range 2)	0 Ω	5000 Ω	±34 ppm/K	±95 ppm/K

The tolerance values refer to the measuring range final value.

Tolerances influenced by electromagnetic interference			
Type of electromagnetic interference	Standard	Tolerance	Criterion
Electromagnetic fields	EN 61000-4-3/ IEC 61000-4-3	< ±1.5%	A
Fast transients (burst)	EN 61000-4-4/ IEC 61000-4-4	< ±0.5%	A
Conducted interference	EN 61000-4-6/ IEC 61000-4-6	< ±1.0%	A

6 Internal circuit diagram

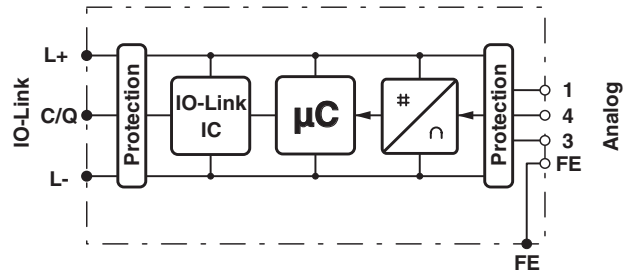
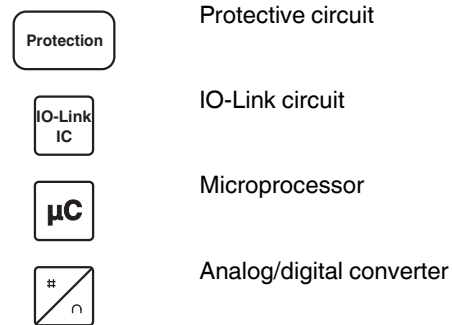

Figure 1 Internal wiring of connections

Key:



7 Pin assignment

7.1 Connections on the device

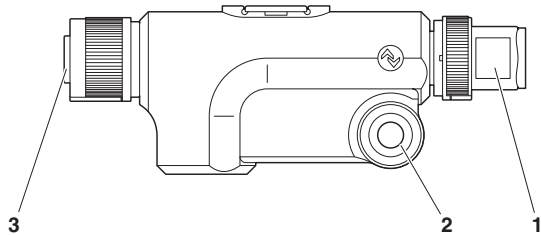

Figure 2 Connections on the converter

No.	Connection
1	IO-Link interface (indicated by IO-Link symbol)
2	Fixing options; options for connection to functional earth ground
3	Analog input

7.2 Pin assignment of the IO-Link interface

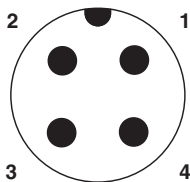

Figure 3 Pin assignment of the I/O link interface (M12 A-coded, pin)

Pin	Signal	Meaning
1	L+	+24 V supply voltage; from IO-Link master
2	-	Not used
3	L-	GND, reference potential for L+
4	C/Q	IO-Link data transmission channel

7.3 Pin assignment of the analog input

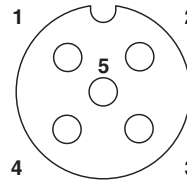

Figure 4 Pin assignment of the analog input (M12 A-coded, socket)

Pin	Assignment
1	U+ RTD sensor +
2	I+ Constant current supply +
3	U- RTD sensor -
4	I- Constant current supply -
5	Not used

8 Connection notes

Always connect the analog sensors using shielded, twisted pair cables.

9 Connection example

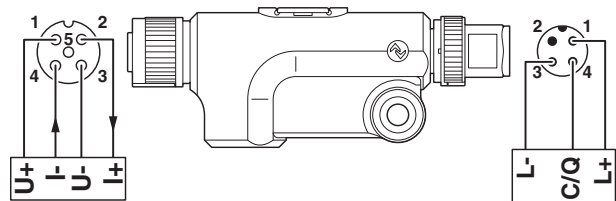

Figure 5 Connection example

10 Assembly



Figure 6 Connection of a sensor to an IO-Link master via the converter

- Connect the IO-Link interface of the converter to an IO-Link port of the higher-level IO-Link master using a standardized 3-pos. cable.
- Connect the analog sensor directly to the analog converter input or using a shielded 4-pos. cable.
- Fasten each connection using the M12 connectors.



In environments with high levels of interference, in particular, Phoenix Contact recommends connecting the converter to an appropriate functional earth ground point using an M4 screw.

11 Local status indicator

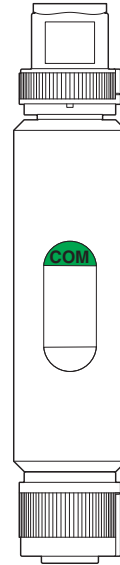

Figure 7 Local status indicator

Designation	Color	Meaning	State	Description
COM	Green	Status of IO-Link device	ON	Supply voltage OK
			Flashing	Supply voltage OK, SDCI communication active
			OFF	No supply voltage, no communication

12 Process data

The device occupies one word of IN process data and one word of OUT process data.

12.1 IN process data

The measured values are depicted in IB IL or S7-compatible format.

15	14	13	12	11	10	9	8	7	6	5	4	3	2	1	0
V	Analog value														

V Sign bit (= 0, not relevant)



By some formats bit 2 ... bit 0 are not relevant for the measured value. They are set to 0.

A diagnostic code is mapped to the input data in the event of an error.

IB IL format

Values > 8000_{hex} and < 8100_{hex} indicate an error.

Code (hex)	Cause
8001	Overrange
8002	Wire break
8003	Short-circuit
8004	Measured value invalid/no valid measured value available
8040	Device faulty
8080	Underrange

S7-compatible format

In the format S7-compatible exist two diagnostic codes, see the following table.

Code (hex)	Cause
7FFF	Overrange
8000	Wire break/short-circuit/underrange

12.2 OUT process data

The device can be configured via the process data output word.

The following configurations are possible:

- Selection of the sensor type
- Selection of formats for representing measured values
- Adjusting the resolution

15	14	13	12	11	10	9	8	7	6	5	4	3	2	1	0
Configuration	Reserved							Resolution	Format		Sensor type				



For the exact meaning of the individual bits, please refer to "Parameterization (80_{hex}: ParaWord)".

12.3 Parameterization via OUT process data

Reparameterization can be carried out via the output process data, however this is not saved permanently on the device.



Please operate the reparameterization only by the startup of the device!

The following sequence applies regardless of the format (IB IL or S7-compatible):

- The master sends parameter data (OutputProcessData with bit 15 = 1)



In order to start configuration, bit 15 of the output word must be set to 1. If bit 15 = 0, the default configuration is active.

- The device interrupts the transmission of current process data and responds with the following diagnostic code in the process data:

Code (hex)	Cause
8800	Parameter OK
8801	Parameter ERROR

- If the diagnostic code is OK, the parameter data is accepted immediately. The master can end parameterization (OutputProcessData with bit 15 = 0). The device returns to normal operation with cyclic process data transmission.
- In the event of the ERROR diagnostic code, the master can abort parameterization without modified parameter data (OutputProcessData with bit 15 = 0) or transmit the modified parameterization (return to step 1).

12.4 Example

The example applies to the following changes:

- Adjusting the resolution from 0.1 °C to 0.1 °F
- Selection of formats S7-compatible (Default) to IB IL
- Selection of the Sensor type Pt 100 DIN (Default) to Linear R 0 Ω ... 500 Ω

15	14	13	12	11	10	9	8	7	6	5	4	3	2	1	0
Configuration	Reserved							Resolution	Format		Sensor type				
1	Reserved							1	0	1	0	1	1	1	0

13 Significant values in various formats

13.1 IB IL format

Input data		R 0 Ω ... 500 Ω	R 0 Ω ... 5 kΩ	Temperature sensors	
Resolution		0.1 Ω	1 Ω	0.1 °C *	0.1 °F *
hex	dec	Ω	Ω	°C	°F
8003	Short-circuit	no (0 Ω)	no (0 Ω)	yes	yes
8002	Wire break	yes	yes	yes	yes
8001	Overrange	> 525	> 5250	> 850	>1562
3D04	15620	-	-	-	1562
2134	8500	-	-	850	850
1482	5250	525	5250	525	525
03E8	1000	100	1000	100	100
0032	50	5	50	5	5
0005	5	0.5	5	0.5	0.5
0001	1	0.1	1	-	-
0000	0	0	0	0	0
FC18	-1000	-	-	-100	-100
F830	-2000	-	-	-200	-200
F330	-3280	-	-	-	-328
8080	Underrange	-	-	< -200	< -328

13.2 S7-compatible format

Input data		R 0 Ω ... 600 Ω	R 0 Ω ... 6 kΩ	Temperature sensors	
Resolution		0.17 Ω	1.7 Ω	0.1 °C *	0.1 °F *
hex	dec	Ω	Ω	°C	°F
8000	Short-circuit	no (0 Ω)	no (0 Ω)	yes	yes
8000	Wire break	yes	yes	yes	yes
7FFF	Overrange	> 705.4	> 7054	> 850	> 1562
7EF8	32504	705.4	7054	-	-
3D04	15620	339	3390	-	1562
2134	8500	184.5	1845	850	850
03E8	1000	21.7	217	100	100
0032	50	1.1	11	50	50
0008	8	0.17	1.7	-	-
0005	5	-	-	0.5	0.5
0000	0	0	0	0	0
FC18	-1000	-	-	-100	-100
F830	-2000	-	-	-200	-200
F330	-3280	-	-	-	< -328
8000	Underrange	-	-	< -200	< -328



* The format representation is based on 0.1 °C/F. The actual resolution is 0.5 °C/F. The measurement is thus always in 0.5 °C/F increments (steps).

14 IO-Link objects

14.1 Overview of the objects

Index (hex)		Object name	Length in bytes	Access	Meaning	Contents
DPP	ISDU					
Identification						
07		Vendor ID	2	R	Manufacturer identification	00 _{hex}
08						B0 _{hex}
09		Device ID	3	R	Device ID	01 _{hex}
0A						00 _{hex}
0B						51 _{hex}
	10	VendorName	Max. 64	R	Manufacturer name	Phoenix Contact
	11	VendorText	Max. 64	R	Notes	www.phoenixcontact.com
	12	ProductName	Max. 64	R	Product designation	AXL E IOL RTD1 M12 S
	13	Product ID	Max. 64	R	Order No.	2700352
	14	ProductText	Max. 64	R	Product text	IO-Link/Analog-Converter Temperature RTD Input Straight
	15	Serial number	Max. 16	R	Serial number	Stored in the production process.
	16	HardwareVersion	Max. 64	R	Hardware version	E.g., 01
	17	FirmwareVersion	Max. 64	R	Firmware version	E.g., 001
Diagnostics						
	20	Error count	2	R	Errors since power up	Number of errors
	28	InputProcessData	2	R	Input process data	Last current data
Parameter						
	80	ParaWord	2	R/W	Parameterization	0000 _{hex}

Abbreviation	Meaning
R	Read
W	Write

14.2 Parameterization (80_{hex}: ParaWord)

Parameterize the device using this object.

In the case of valid parameters, the parameterization is permanently stored on the device.

After a reset, the device operates with the last permanently stored data. Upon delivery, the device operates with the default data (default settings).



Saving data to the device leads to a communication failure of around 30 ms.

15	14	13	12	11	10	9	8	7	6	5	4	3	2	1	0
Reserved								Resolution for sensor type		Format		Sensor type			

In the following tables the values in **bold** are default settings.

Sensor type	
Code (bin)	Meaning
0000	Pt 100 DIN
0001	Pt 1000 SAMA
1110	IB IL format: Linear R 0 Ω ... 500 Ω S7-compatible format: Linear R 0 Ω ... 600 Ω
1111	IB IL format: Linear R 0 Ω ... 5 kΩ S7-compatible format Linear R 0 Ω ... 6 kΩ
Other	Reserved

Format	
Code (bin)	Meaning
00	S7-compatible
10	IB IL
Other	Reserved

Resolution for sensor type			
Code (bin)	Temperature sensors	Linear R 0 Ω ... 500 Ω / 600 Ω	Linear R 0 Ω ... 5 kΩ / 6 kΩ
00	0.1 °C (0.5 °C increments)	IB IL format: 0,1 Ω S7-compatible format: 0,17 Ω	Format IB IL: 1,0 Ω Format S7-kompatibel: 1,7 Ω
10	0.1 °F (0.5 °F increments)	Reserved	Reserved
Other	Reserved		