

TYPE	INTRINSIC STANDOFF RATIO η		INTERBASE RESISTANCE r_{BB}		PEAK-POINT CURRENT I_p	EMITTER REV. CURRENT $I_{EB20 @ V_{B2E}}$		VALLEY-POINT CURRENT I_v	BASE 1 PEAK VOLTAGE V_{OB1}	CASE
	MIN.	MAX.	MIN.	MAX.	MAX.	MAX.		MIN.	MIN.	
			k Ω	k Ω	μA	μA	V	mA	V	
2N2417	0.51	0.62	4.7	6.8	12	2.0	60	8.0	-	
2N2417A	0.51	0.62	4.7	6.8	12	2.0	60	8.0	3.0	
2N2417B	0.51	0.62	4.7	6.8	6.0	0.2	30	8.0	3.0	
2N2418	0.51	0.62	6.2	9.1	12	2.0	60	8.0	-	
2N2418A	0.51	0.62	6.2	9.1	12	2.0	60	8.0	3.0	
2N2418B	0.51	0.62	6.2	9.1	6.0	0.2	30	8.0	3.0	
2N2419	0.56	0.68	4.7	6.8	12	2.0	60	8.0	-	
2N2419A	0.56	0.68	4.7	6.8	12	2.0	60	8.0	3.0	
2N2419B	0.56	0.68	4.7	6.8	6.0	0.2	30	8.0	3.0	
2N2420	0.56	0.68	6.2	9.1	12	2.0	60	8.0	-	
2N2420A	0.56	0.68	6.2	9.1	12	2.0	60	8.0	3.0	
2N2420B	0.56	0.68	6.2	9.1	6.0	0.2	30	8.0	3.0	
2N2421	0.62	0.75	4.7	6.8	12	2.0	60	8.0	-	
2N2421A	0.62	0.75	4.7	6.8	12	2.0	60	8.0	3.0	
2N2421B	0.62	0.75	4.7	6.8	6.0	0.2	30	8.0	3.0	
2N2422	0.62	0.75	6.2	9.1	12	2.0	60	8.0	-	
2N2422A	0.62	0.75	6.2	9.1	12	2.0	60	8.0	3.0	
2N2422B	0.62	0.75	6.2	9.1	6.0	0.2	30	8.0	3.0	
2N2646	0.56	0.75	4.7	9.1	5.0	12	30	4.0	3.0	
2N2647	0.68	0.82	4.7	9.1	2.0	0.2	30	8.0	6.0	
2N2840	0.62*	-	4.7	9.1	10	1.0	30	.20	-	
2N3980	0.68	0.82	4.0	8.0	2.0	0.01	30	1.0	6.0	
2N4851	0.56	0.75	4.7	9.1	2.0	0.1	30	2.0	3.0	
2N4852	0.70	0.85	4.7	9.1	2.0	0.1	30	4.0	5.0	
2N4853	0.70	0.85	4.7	9.1	0.4	0.05	30	6.0	6.0	
2N4947	0.51	0.69	4.0	9.1	2.0	0.01	30	4.0	3.0	
2N4948	0.55	0.82	4.0	12	2.0	0.01	30	2.0	6.0	
2N4949	0.74	0.86	4.0	12	1.0	0.01	30	2.0	3.0	
2N5431	0.72	0.80	6.0	8.5	0.4	0.01	30	2.0	1.0	
MU20	0.50	0.85	4.0	10	5.0	1.0	30	1.0	3.0	
MU2646M	0.56	0.75	4.7	9.1	5.0	12	30	2.0	3.0	

*Typical Value

TABLE C UNIJUNCTION TRANSISTORS TO-92 CASE



TYPE	INTRINSIC STANDOFF RATIO η		INTERBASE RESISTANCE r_{BB}		PEAK-POINT CURRENT I_p	EMITTER REV. CURRENT $I_{EB20 @ V_{B2E}}$		VALLEY-POINT CURRENT I_v	BASE 1 PEAK VOLTAGE V_{OB1}	CASE
	MIN.	MAX.	MIN.	MAX.	MAX.	MAX.		MIN.	MIN.	
			k Ω	k Ω	μA	μA	V	mA	V	
2N4870	0.56	0.75	4.0	9.1	5.0	1.0	30	2.0	3.0	
2N4871	0.70	0.85	4.0	9.1	5.0	1.0	30	4.0	5.0	
MU10	0.50	0.85	4.0	10	5.0	1.0	30	1.0	3.0	
MU2646	0.56	0.75	4.7	9.1	5.0	12	30	4.0	3.0	
MU4891	0.55	0.82	4.0	9.1	5.0	0.01	30	2.0	3.0	
MU4892	0.51	0.69	4.0	9.1	2.0	0.01	30	2.0	3.0	
MU4893	0.55	0.82	4.0	12	2.0	0.01	30	2.0	6.0	
MU4894	0.74	0.86	4.0	12	1.0	0.01	30	2.0	3.0	

TABLE D PROGRAMMABLE UNIJUNCTION TRANSISTORS TO-92 CASE

TYPE	MAXIMUM RATINGS		GATE TO ANODE LEAKAGE CURRENT $I_{GAO @ 40v}$	PEAK CURRENT I_p		VALLEY CURRENT I_v		CASE
	GATE TO ANODE REVERSE VOLTAGE V_{GAR}	DC ANODE CURRENT I_T		$R_G = 10k\Omega$		$R_G = 1.0M\Omega$		
			MAX.	MAX.	MAX.	MIN.	MAX.	
	V	mA	nA	μA	μA	μA	μA	
2N8027	40	150	10	5.0	2.0	70	50	
2N8028	40	150	10	1.0	0.15	25	25	
A7T8027	40	150	10	5.0	2.0	70	50	
A7T8028	40	150	10	1.0	0.15	25	25	

CASE OUTLINE DRAWINGS

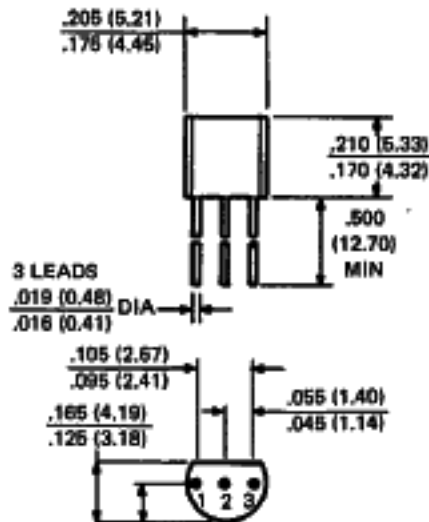

LEAD CODE:
1. BASE 1
2. EMITTER
3. BASE 2

TO-92 (UJT)

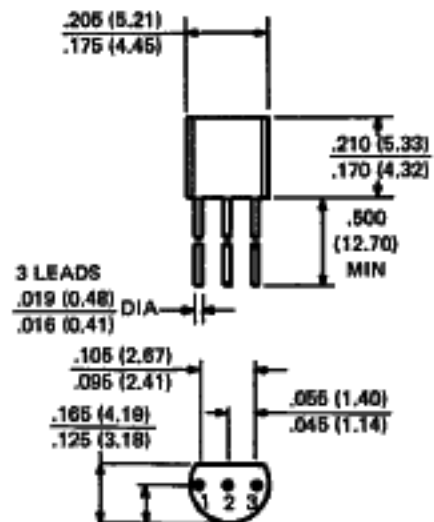

LEAD CODE:
1. ANODE (A)
2. GATE (G)
3. CATHODE (K)

TO-92 (PUT)

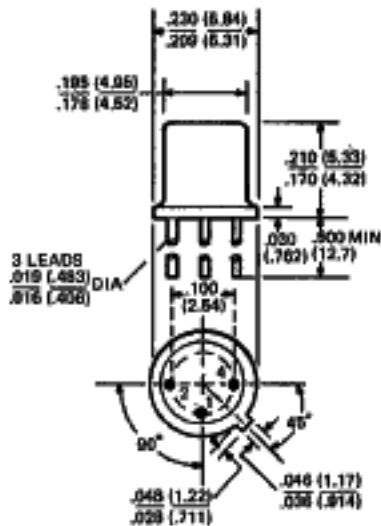

LEAD CODE:
1. EMITTER
2. BASE 1
4. BASE 2

TO-18*

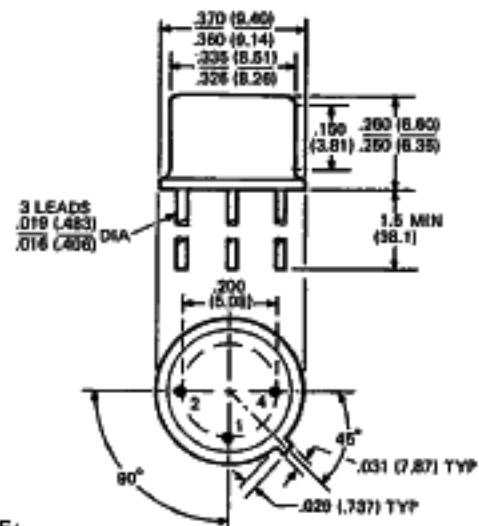

LEAD CODE:
1. EMITTER
2. BASE 1
4. BASE 2

TO-5*

DIMENSIONS IN INCHES (MILLIMETERS)

DRAWINGS NOT TO SCALE.

*Conforms to JEDEC outline except for lead configuration.

TM

Central Semiconductor Corp.

145 Adams Avenue
Hauppauge, NY 11788
Tel: (516) 435-1110
TWX: (510) 224-6493

MANUFACTURERS OF DISCRETE SEMICONDUCTORS

CASE OUTLINE DRAWINGS

D

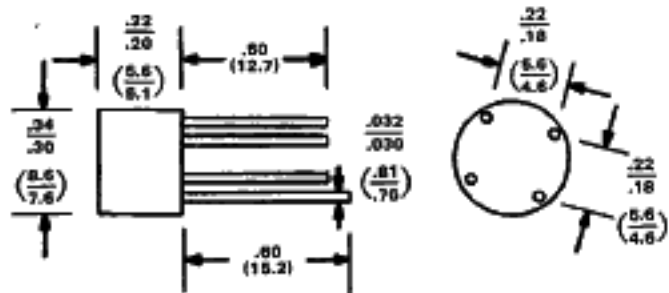

CASE A

CBR1 Series
CBR2 Series

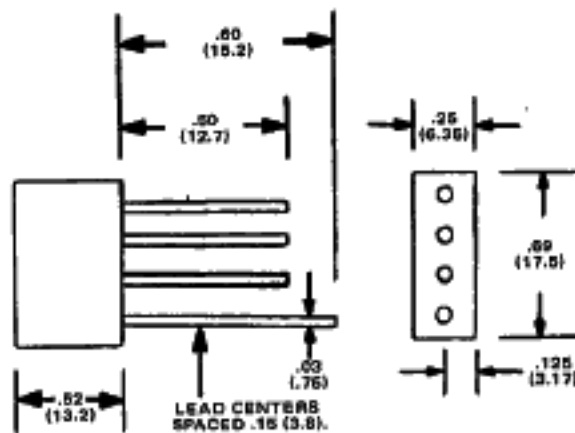

CASE B

CBR1-L Series
CBR2-L Series

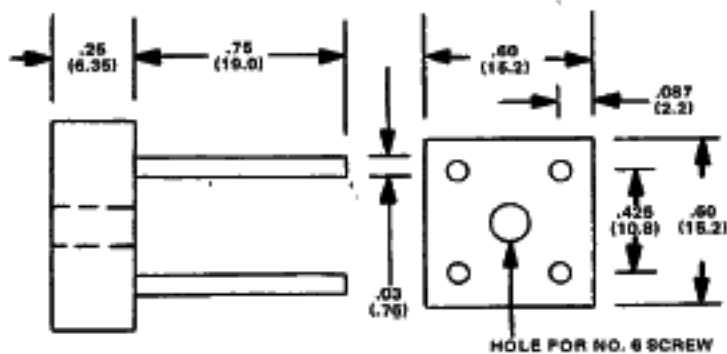

CASE C

CBR3-P Series

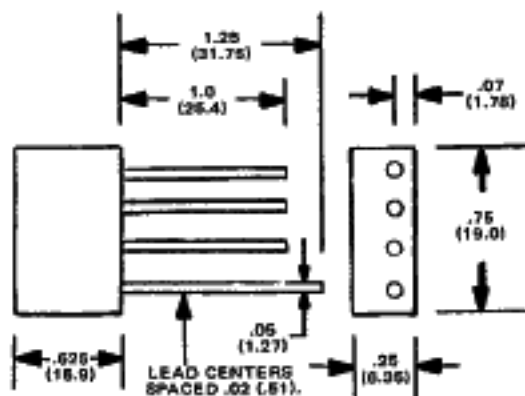

CASE D

CBR4-L Series

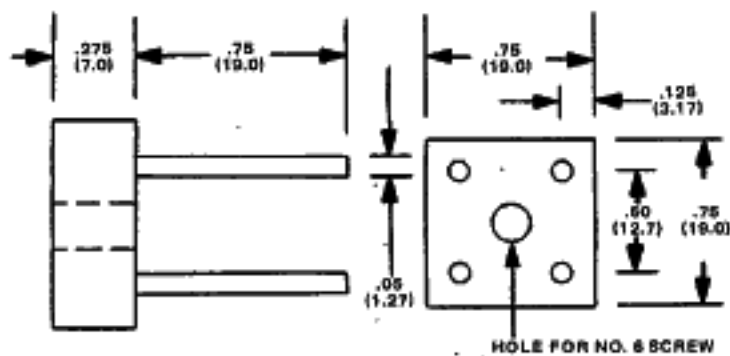

CASE E

CBR8 Series

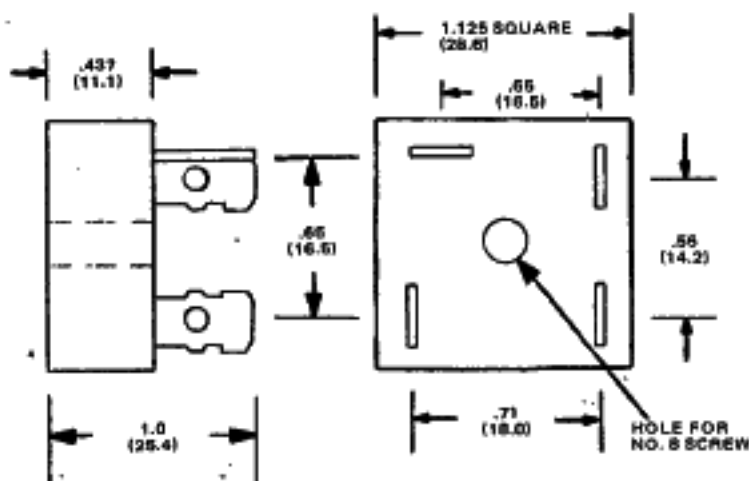

CASE F

CBR10 Series, CBR25 Series
CBR12 Series, CBR30 Series

All Dimensions in Inches (Millimeters)

Drawings Not To Scale

MECHANICAL OUTLINE DRAWINGS

D

TO-5

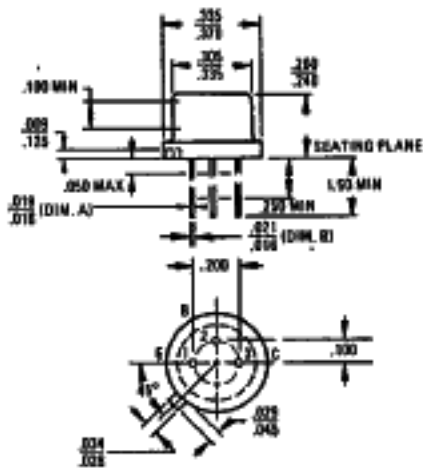

TO-18

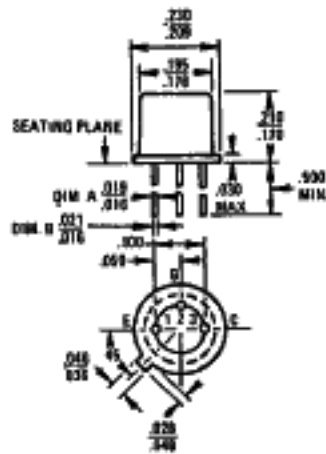

TO-39

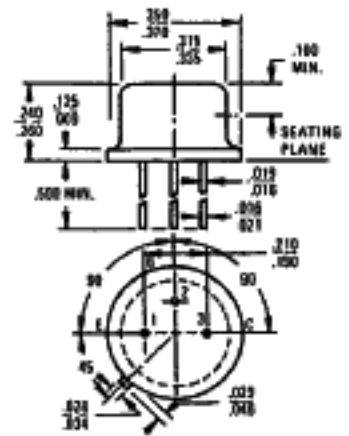

TO-46

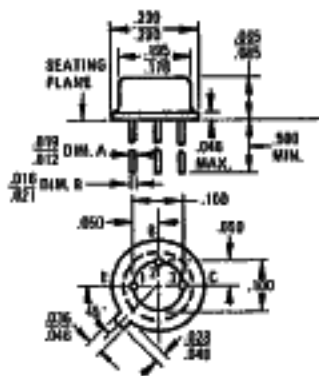

TO-72

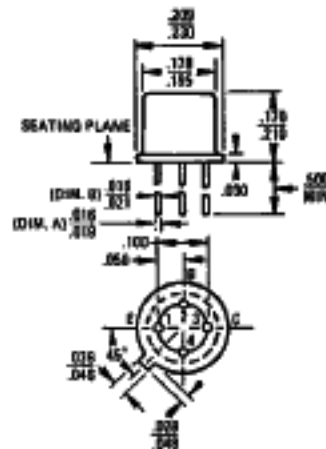

TO-92

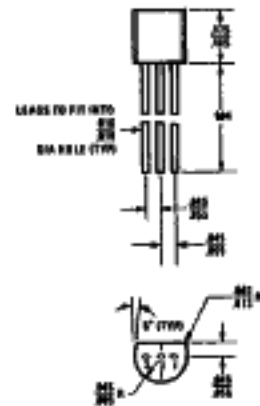

TO-98

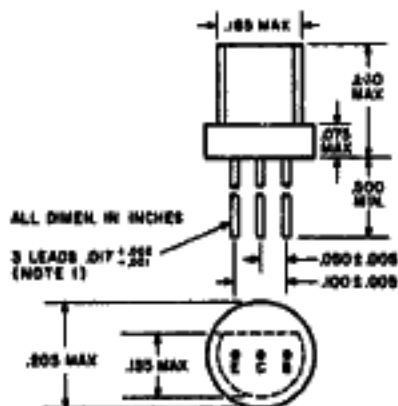

TO-105

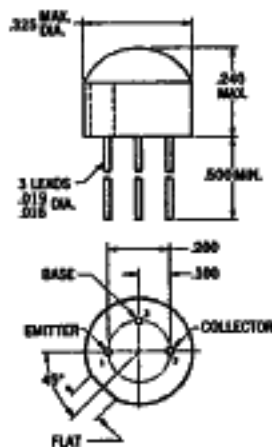

TO-106

