

DIGITRON SEMICONDUCTORS

2N4870-2N4871

PN UNIJUNCTION TRANSISTORS

MAXIMUM RATINGS

Rating	Symbol	Value	Unit
RMS power dissipation ⁽¹⁾	P_D	300	mW
RMS emitter current	I_E	50	mA
Peak pulse emitter current ⁽²⁾	i_e	1.5	Amp
Emitter reverse voltage	V_{B2E}	30	Volts
Interbase voltage †	V_{B2B1}	35	Volts
Operating junction temperature range	T_J	-55 to 125	°C
Storage temperature range	T_{stg}	-55 to 150	°C

Note 1: Derate 3.04mW/°C increase in ambient temperature.

Note 2: Duty cycle ≤ 1%. PRR = 10PPS.

† Base upon power dissipation at $T_A = 25^\circ\text{C}$.

ELECTRICAL CHARACTERISTICS ($T_A = 25^\circ\text{C}$ unless otherwise noted)

Characteristic		Symbol	Min	Typ	Max	Unit
Intrinsic standoff ratio ($V_{B2B1} = 10V$) ⁽¹⁾	2N4870	η	0.56	-	0.75	-
	2N4871		0.70	-	0.85	
Interbase resistance ($V_{B2B1} = 3.0V, I_E = 0$)		R_{BB}	4.0	6.0	9.1	kohms
Interbase resistance temperature coefficient ($V_{B2B1} = 3.0V, I_E = 0, T_A = -65^\circ\text{ to } 125^\circ\text{C}$)		αR_{BB}	0.1	-	0.9	%/°C
Emitter saturation voltage ($V_{B2B1} = 10V, I_E = 50\text{mA}$) ⁽²⁾		$V_{EB1(sat)}$	-	2.5	-	Volts
Modulated interbase current ($V_{B2B1} = 10V, I_E = 50\text{mA}$)		$I_{B2(mod)}$	-	15	-	mA
Emitter reverse current ($V_{B2E} = 30V, I_{B1} = 0$)		I_{EB20}	-	0.005	1.0	μA
Peak point emitter current ($V_{B2B1} = 25V$)		I_P	-	1.0	5.0	μA
Valley point current ($V_{B2B1} = 20V, R_{B2} = 100\text{ohms}$) ⁽²⁾	2N4870	I_V	2.0	5.0	-	mA
	2N4871		4.0	7.0	-	
Base-one peak pulse voltage	2N4870	V_{OB1}	3.0	6.0	-	Volts
	2N4871		5.0	8.0	-	

Note 1: Intrinsic standoff ration: $V_P = \eta V_{B2B1} + V_F$, where V_F is about 0.49V at 25°C @ $I_F = 10\mu\text{A}$ and decreases with temperature at about 2.5mV/°C. Components R1, C1, and the UJT form a relaxation oscillator; the remaining circuitry serves as a peak -voltage detector. The forward drop of diode D1 compensates for V_R . To use, the "cal" button is pushed and R3 is adjusted to make the current meter, M1, read full scale. When the "cal" button is released, the value of η is read directly from the meter, if full scale on the meter reads 1.0.

Note 2: Use pulse techniques: $PW \approx 300\mu\text{s}$ duty cycle ≤ 2% to avoid internal heating due to interbase modulation which may result in erroneous readings.

Available Non-RoHS (standard) or RoHS compliant (add PBF suffix).

Available as "HR" (high reliability) screened per MIL-PRF-19500, JANTX level. Add "HR" suffix to base part number.

DIGITRON SEMICONDUCTORS

2N4870-2N4871

PN UNIJUNCTION TRANSISTORS

V_{OB1} TEST CIRCUIT

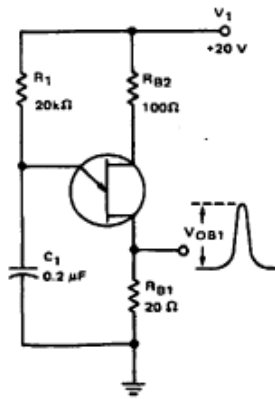

η TEST CIRCUIT

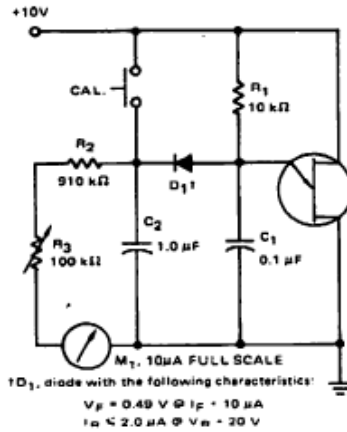

PRR TEST CIRCUIT AND WAVEFORM

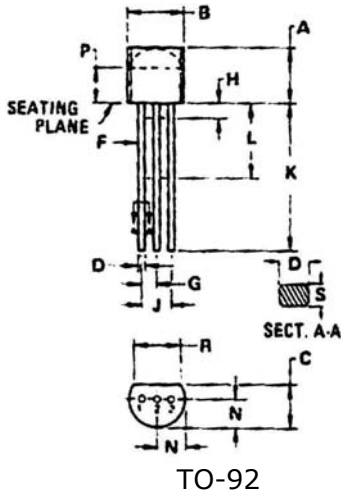
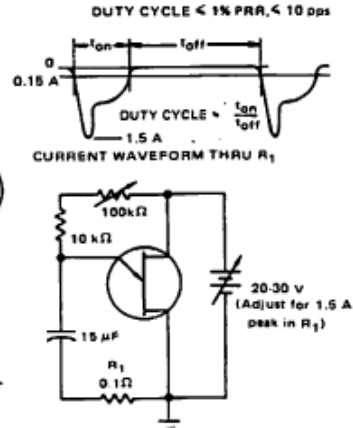

Dim	Inches		Millimeters	
	Min	Max	Min	Max
A	0.170	0.210	4.320	5.330
B	0.175	0.205	4.440	5.210
C	0.125	0.165	3.180	4.190
D	0.016	0.022	0.410	0.560
F	0.016	0.019	0.410	0.480
G	0.045	0.055	1.140	1.400
H	-	0.100	-	2.540
J	0.095	0.105	2.410	2.670
K	0.500	-	12.700	-
L	0.250	-	6.350	-
N	0.080	0.115	2.030	2.920
P	0.115	-	2.920	-
R	0.135	-	3.430	-
S	0.014	0.016	0.360	0.410

Pin 1: Base 1
Pin 2: Emitter
Pin 3: Base 2

UNIUNCTION TRANSISTOR SYMBOL AND NOMENCLATURE

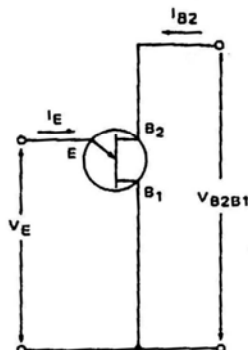

STATIC EMITTER CHARACTERISTICS CURVES

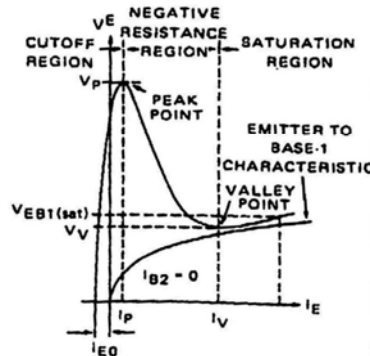

DIGITRON SEMICONDUCTORS

2N4870-2N4871

PN UNIJUNCTION TRANSISTORS

TYPICAL CHARACTERISTICS

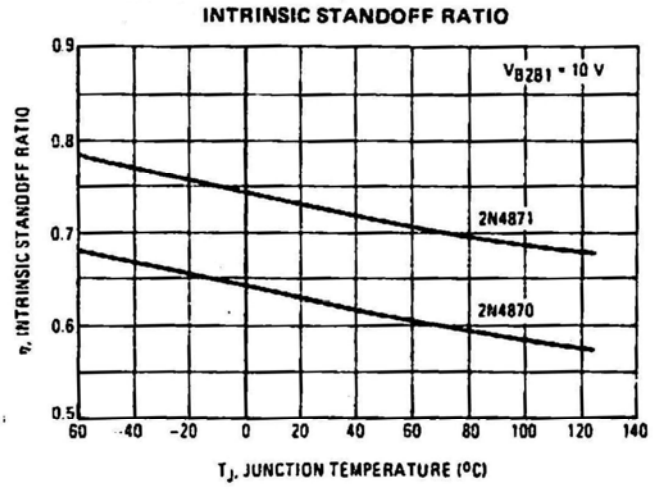
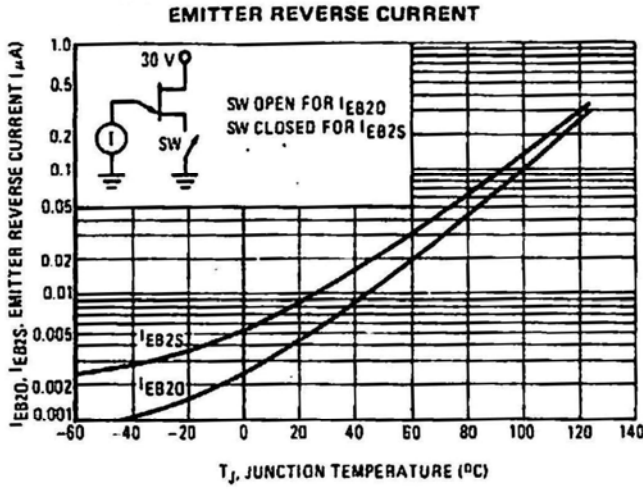

PEAK POINT CURRENT

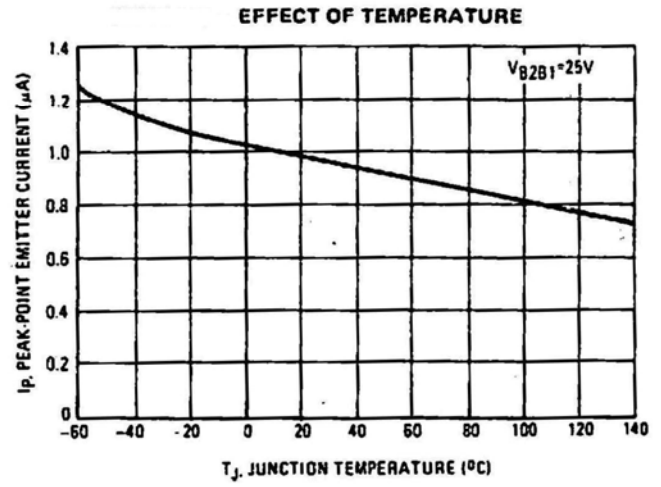
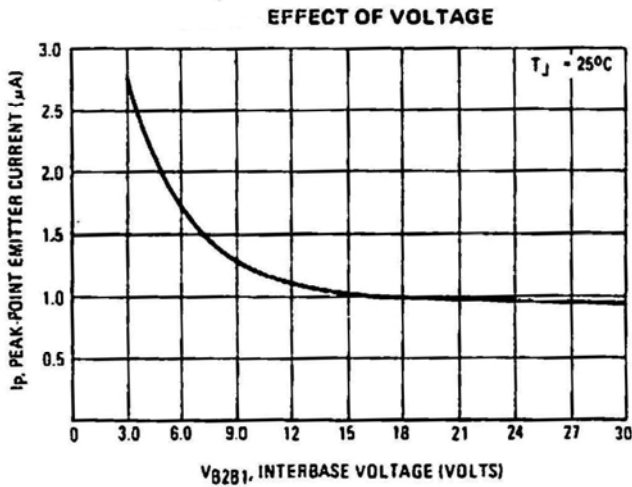

INTERBASE RESISTANCE

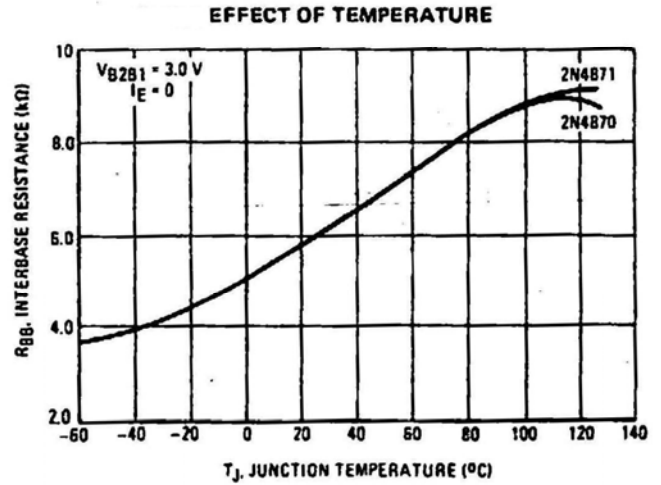
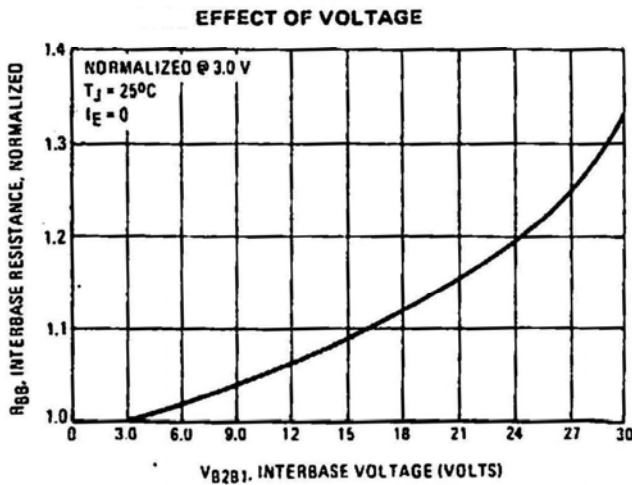

DIGITRON SEMICONDUCTORS

2N4870-2N4871

PN UNIJUNCTION TRANSISTORS

TYPICAL CHARACTERISTICS

VALLEY CURRENT

EFFECT OF VOLTAGE

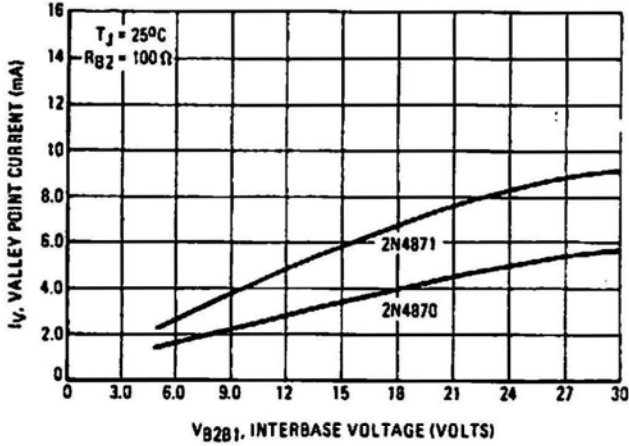

EFFECT OF TEMPERATURE

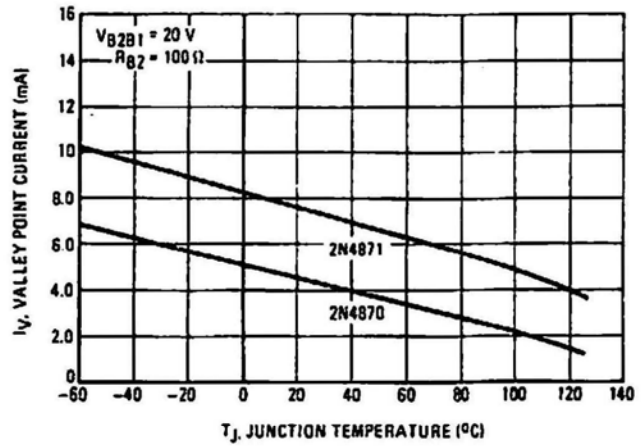

VALLEY VOLTAGE

EFFECT OF VOLTAGE

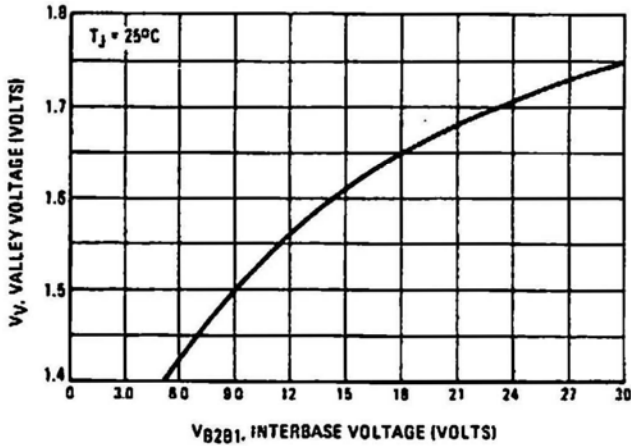

EFFECT OF TEMPERATURE

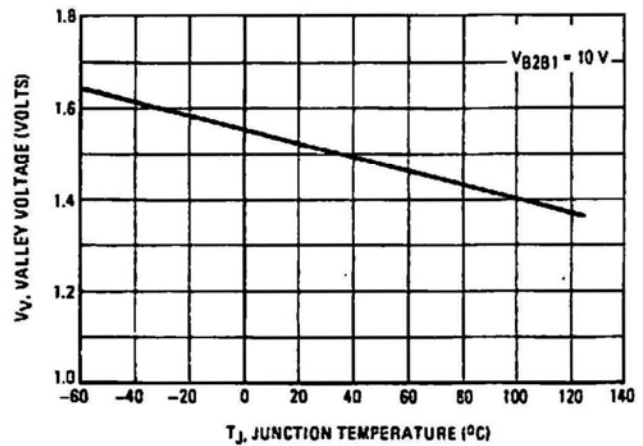

OUTPUT VOLTAGE

