

# Sensitive SCRs

(0.8 A to 10 A) RoHS

## General Description

The Teccor line of sensitive SCR semiconductors are half-wave unidirectional, gate-controlled rectifiers (SCR-thyristor) which complement Teccor's line of power SCRs. This group of packages offers ratings of 0.8 A to 10 A, and 200 V to 600 V with gate sensitivities of 12  $\mu$ A to 500  $\mu$ A. For gate currents in the 10 mA to 50 mA ranges, see "SCRs" section of this catalog.

The TO-220 and TO-92 are electrically isolated where the case or tab is internally isolated to allow the use of low-cost assembly and convenient packaging techniques.

Teccor's line of SCRs features glass-passivated junctions to ensure long-term device reliability and parameter stability. Teccor's glass offers a rugged, reliable barrier against junction contamination.

Tape-and-reel packaging is available for the TO-92 package. Consult the factory for more information.





Variations of devices covered in this data sheet are available for custom design applications. Consult the factory for more information.

## Features

- RoHS Compliant
- Electrically-isolated TO-220 package
- High voltage capability — up to 600 V
- High surge capability — up to 100 A
- Glass-passivated chip

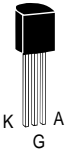
## Compak Features

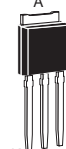
- Surface mount package — 0.8 A series
- New small-profile three-leaded Compak package
- Four gate sensitivities available
- Packaged in embossed carrier tape with 2,500 devices per reel
- Can replace SOT-223

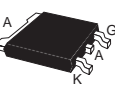
TYPE	Part Number					$I_T$		$V_{DRM}$ & $V_{RRM}$	$I_{GT}$	$I_{DRM}$ & $I_{RRM}$			$V_{TM}$	
	Non-isolated					$I_T$				$\mu\text{Amps}$	$\mu\text{Amps}$			
						(1)		(2) (12) (14) (18)	(20) (21)			(3) (10)		
	TO-92	TO-202	TO-251 V-Pak	Compak	TO-252 D-Pak	Amps		Volts	$T_C$ or $T_L = 25^\circ\text{C}$	$T_C$ or $T_L = 100^\circ\text{C}$	$T_C$ or $T_L = 110^\circ\text{C}$	Volts		
	See "Package Dimensions" section for variations. (11)					$I_{T(RMS)}$	$I_{T(AV)}$	MIN	MAX	MAX			MAX	
				<b>S2S1</b>		<b>0.8</b>	<b>0.51</b>	<b>200</b>	<b>12</b>	<b>2</b>		<b>100</b>	<b>1.7</b>	
				<b>S4S1</b>		<b>0.8</b>	<b>0.51</b>	<b>400</b>	<b>12</b>	<b>2</b>		<b>100</b>	<b>1.7</b>	
				<b>S6S1</b>		<b>0.8</b>	<b>0.51</b>	<b>600</b>	<b>12</b>	<b>2</b>		<b>100</b>	<b>1.7</b>	
				<b>S2S2</b>		<b>0.8</b>	<b>0.51</b>	<b>200</b>	<b>50</b>	<b>2</b>		<b>100</b>	<b>1.7</b>	
				<b>S4S2</b>		<b>0.8</b>	<b>0.51</b>	<b>400</b>	<b>50</b>	<b>2</b>		<b>100</b>	<b>1.7</b>	
				<b>S6S2</b>		<b>0.8</b>	<b>0.51</b>	<b>600</b>	<b>50</b>	<b>2</b>		<b>100</b>	<b>1.7</b>	
				<b>S2S</b>		<b>0.8</b>	<b>0.51</b>	<b>200</b>	<b>200</b>	<b>2</b>		<b>100</b>	<b>1.7</b>	
				<b>S4S</b>		<b>0.8</b>	<b>0.51</b>	<b>400</b>	<b>200</b>	<b>2</b>		<b>100</b>	<b>1.7</b>	
				<b>S6S</b>		<b>0.8</b>	<b>0.51</b>	<b>600</b>	<b>200</b>	<b>2</b>		<b>100</b>	<b>1.7</b>	
				<b>S2S3</b>		<b>0.8</b>	<b>0.51</b>	<b>200</b>	<b>500</b>	<b>2</b>		<b>100</b>	<b>1.7</b>	
				<b>S4S3</b>		<b>0.8</b>	<b>0.51</b>	<b>400</b>	<b>500</b>	<b>2</b>		<b>100</b>	<b>1.7</b>	
				<b>S6S3</b>		<b>0.8</b>	<b>0.51</b>	<b>600</b>	<b>500</b>	<b>2</b>		<b>100</b>	<b>1.7</b>	
<b>0.8 A</b>				<b>EC103B</b>		<b>0.8</b>	<b>0.51</b>	<b>200</b>	<b>200</b>	<b>1</b>	<b>50</b>		<b>1.7</b>	
				<b>EC103D</b>		<b>0.8</b>	<b>0.51</b>	<b>400</b>	<b>200</b>	<b>1</b>	<b>50</b>		<b>1.7</b>	
				<b>EC103M</b>		<b>0.8</b>	<b>0.51</b>	<b>600</b>	<b>200</b>	<b>2</b>	<b>100</b>		<b>1.7</b>	
				<b>EC103B1</b>		<b>0.8</b>	<b>0.51</b>	<b>200</b>	<b>12</b>	<b>1</b>	<b>50</b>		<b>1.7</b>	
				<b>EC103D1</b>		<b>0.8</b>	<b>0.51</b>	<b>400</b>	<b>12</b>	<b>1</b>	<b>50</b>		<b>1.7</b>	
				<b>EC103M1</b>		<b>0.8</b>	<b>0.51</b>	<b>600</b>	<b>12</b>	<b>2</b>	<b>100</b>		<b>1.7</b>	
				<b>EC103B2</b>		<b>0.8</b>	<b>0.51</b>	<b>200</b>	<b>50</b>	<b>1</b>	<b>50</b>		<b>1.7</b>	
				<b>EC103D2</b>		<b>0.8</b>	<b>0.51</b>	<b>400</b>	<b>50</b>	<b>1</b>	<b>50</b>		<b>1.7</b>	
				<b>EC103M2</b>		<b>0.8</b>	<b>0.51</b>	<b>600</b>	<b>50</b>	<b>2</b>	<b>100</b>		<b>1.7</b>	
				<b>EC103B3</b>		<b>0.8</b>	<b>0.51</b>	<b>200</b>	<b>500</b>	<b>1</b>	<b>50</b>		<b>1.7</b>	
				<b>EC103D3</b>		<b>0.8</b>	<b>0.51</b>	<b>400</b>	<b>500</b>	<b>1</b>	<b>50</b>		<b>1.7</b>	
				<b>EC103M3</b>		<b>0.8</b>	<b>0.51</b>	<b>600</b>	<b>500</b>	<b>2</b>	<b>100</b>		<b>1.7</b>	
				<b>2N5064</b>		<b>0.8</b>	<b>0.51</b>	<b>200</b>	<b>200</b>	<b>1</b>		<b>50</b>	<b>1.7</b>	
				<b>2N6565</b>		<b>0.8</b>	<b>0.51</b>	<b>400</b>	<b>200</b>	<b>1</b>		<b>100</b>	<b>1.7</b>	
	<b>1.5 A</b>				<b>TCR22-4</b>		<b>1.5</b>	<b>0.95</b>	<b>200</b>	<b>200</b>	<b>1</b>		<b>100</b>	<b>1.5</b>
					<b>TCR22-6</b>		<b>1.5</b>	<b>0.95</b>	<b>400</b>	<b>200</b>	<b>1</b>		<b>100</b>	<b>1.5</b>
				<b>TCR22-8</b>		<b>1.5</b>	<b>0.95</b>	<b>600</b>	<b>200</b>	<b>2</b>		<b>100</b>	<b>1.5</b>	
<b>4 A</b>				<b>T106B1</b>		<b>4</b>	<b>2.5</b>	<b>200</b>	<b>200</b>	<b>2</b>		<b>100</b>	<b>2.2</b>	
				<b>T106D1</b>		<b>4</b>	<b>2.5</b>	<b>400</b>	<b>200</b>	<b>2</b>		<b>100</b>	<b>2.2</b>	
				<b>T106M1</b>		<b>4</b>	<b>2.5</b>	<b>600</b>	<b>200</b>	<b>2</b>		<b>100</b>	<b>2.2</b>	
				<b>T107B1</b>		<b>4</b>	<b>2.5</b>	<b>200</b>	<b>500</b>	<b>2</b>		<b>100</b>	<b>2.5</b>	
				<b>T107D1</b>		<b>4</b>	<b>2.5</b>	<b>400</b>	<b>500</b>	<b>2</b>		<b>100</b>	<b>2.5</b>	
				<b>T107M1</b>		<b>4</b>	<b>2.5</b>	<b>600</b>	<b>500</b>	<b>2</b>		<b>100</b>	<b>2.5</b>	
				<b>S2004VS1</b>	<b>S2004DS1</b>	<b>4</b>	<b>2.5</b>	<b>200</b>	<b>50</b>	<b>2</b>		<b>100</b>	<b>1.6</b>	
				<b>S4004VS1</b>	<b>S4004DS1</b>	<b>4</b>	<b>2.5</b>	<b>400</b>	<b>50</b>	<b>2</b>		<b>100</b>	<b>1.6</b>	
				<b>S6004VS1</b>	<b>S6004DS1</b>	<b>4</b>	<b>2.5</b>	<b>600</b>	<b>50</b>	<b>2</b>		<b>100</b>	<b>1.6</b>	
				<b>S2004VS2</b>	<b>S2004DS2</b>	<b>4</b>	<b>2.5</b>	<b>200</b>	<b>200</b>	<b>2</b>		<b>100</b>	<b>1.6</b>	
			<b>S4004VS2</b>	<b>S4004DS2</b>	<b>4</b>	<b>2.5</b>	<b>400</b>	<b>200</b>	<b>2</b>		<b>100</b>	<b>1.6</b>		
			<b>S6004VS2</b>	<b>S6004DS2</b>	<b>4</b>	<b>2.5</b>	<b>600</b>	<b>200</b>	<b>2</b>		<b>100</b>	<b>1.6</b>		

See "General Notes" on page E5 - 4 and "Electrical Specifications Notes" on page E5 - 5

V <sub>GT</sub>			I <sub>H</sub>	I <sub>GM</sub>	V <sub>GRM</sub>	P <sub>GM</sub>	P <sub>G(AV)</sub>	I <sub>TSM</sub>	dv/dt		di/dt	t <sub>gt</sub>	t <sub>q</sub>	I <sup>2</sup> t
(4) (12) (22)			(5) (15) (16) (19)	(17)		(17)		(6) (7) (13)				(8)	(9)	
Volts								Amps						
T <sub>C</sub> or T <sub>L</sub> = -40 °C	T <sub>C</sub> or T <sub>L</sub> = 25 °C	T <sub>C</sub> or T <sub>L</sub> = 110 °C	mAmps	Amps	Volts	Watts	Watts	60/50 Hz		Volts/μSec	Amps/μSec	μSec	μSec	Amps <sup>2</sup> /Sec
MAX			MAX		MIN				MIN	TYP (23)		TYP	MAX	
1.2	0.8	0.2	5	1	5	1	0.1	20/16	20		50	2	60	1.6
1.2	0.8	0.2	5	1	5	1	0.1	20/16	20		50	2	60	1.6
1.2	0.8	0.2	5	1	5	1	0.1	20/16	10		50	2	60	1.6
1.2	0.8	0.25	5	1	5	1	0.1	20/16	25		50	3	60	1.6
1.2	0.8	0.25	5	1	5	1	0.1	20/16	25		50	3	60	1.6
1.2	0.8	0.25	5	1	5	1	0.1	20/16	10		50	3	60	1.6
1.2	0.8	0.25	5	1	5	1	0.1	20/16	30		50	4	50	1.6
1.2	0.8	0.25	5	1	5	1	0.1	20/16	30		50	4	50	1.6
1.2	0.8	0.25	5	1	5	1	0.1	20/16	15		50	4	50	1.6
1.2	0.8	0.25	8	1	5	1	0.1	20/16	40		50	5	45	1.6
1.2	0.8	0.25	8	1	5	1	0.1	20/16	40		50	5	45	1.6
1.2	0.8	0.25	8	1	5	1	0.1	20/16	20		50	5	45	1.6
1.2	0.8	0.25	5	1	5	1	0.1	20/16	30		50	3.5	50	1.6
1.2	0.8	0.25	5	1	5	1	0.1	20/16	30		50	3.5	50	1.6
1.2	0.8	0.25	5	1	5	1	0.1	20/16	15		50	3.5	50	1.6
1.2	0.8	0.2	5	1	5	1	0.1	20/16	20		50	2	60	1.6
1.2	0.8	0.2	5	1	5	1	0.1	20/16	20		50	2	60	1.6
1.2	0.8	0.2	5	1	5	1	0.1	20/16	10		50	2	60	1.6
1.2	0.8	0.25	5	1	5	1	0.1	20/16	25		50	3	60	1.6
1.2	0.8	0.25	5	1	5	1	0.1	20/16	25		50	3	60	1.6
1.2	0.8	0.25	5	1	5	1	0.1	20/16	10		50	3	60	1.6
1.2	0.8	0.25	8	1	5	1	0.1	20/16	40		50	5	45	1.6
1.2	0.8	0.25	8	1	5	1	0.1	20/16	40		50	5	45	1.6
1.2	0.8	0.25	8	1	5	1	0.1	20/16	20		50	5	45	1.6
1.2	0.8	0.25	5	1	5	1	0.1	20/16	25		50	2.2	60	1.6
1.2	0.8	0.25	5	1	6	1	0.1	20/16	25		50	2.2	60	1.6
1	0.8	0.25	5	1	6	1	0.1	20/16	60		50	3.5	50	1.6
1	0.8	0.25	5	1	6	1	0.1	20/16	40		50	3.5	50	1.6
1	0.8	0.25	5	1	6	1	0.1	20/16	30		50	3.5	50	1.6
1	0.8	0.2	5	1	6	1	0.1	20/16		8	50	4	50	1.6
1	0.8	0.2	5	1	6	1	0.1	20/16		8	50	4	50	1.6
1	0.8	0.2	5	1	6	1	0.1	20/16		8	50	4	50	1.6
1	0.8	0.2	6	1	6	1	0.1	20/16		8	50	5	45	1.6
1	0.8	0.2	6	1	6	1	0.1	20/16		8	50	5	45	1.6
1	0.8	0.2	6	1	6	1	0.1	20/16		8	50	5	45	1.6
1	0.8	0.2	4	1	6	1	0.1	30/25		8	50	3	50	3.7
1	0.8	0.2	4	1	6	1	0.1	30/25		8	50	3	50	3.7
1	0.8	0.2	4	1	6	1	0.1	30/25		8	50	3	50	3.7
1	0.8	0.2	6	1	6	1	0.1	30/25		8	50	4	50	3.7
1	0.8	0.2	6	1	6	1	0.1	30/25		8	50	4	50	3.7
1	0.8	0.2	6	1	6	1	0.1	30/25		8	50	4	50	3.7

See "General Notes" on page E5 - 4 and "Electrical Specifications Notes" on page E5 - 5

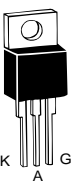
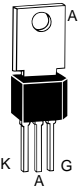
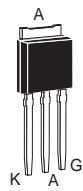
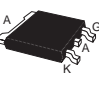
TYPE	Part Number				I <sub>T</sub>		V <sub>DRM</sub> & V <sub>R<sub>RRM</sub></sub>	I <sub>GT</sub>	I <sub>DRM</sub> & I <sub>R<sub>RRM</sub></sub>		V <sub>TM</sub>
	Isolated	Non-isolated									
	 TO-220	 TO-202	 TO-251 V-Pak	 TO-252 D-Pak	(1)			(2) (12)	(20) (21)		(3) (10)
	See "Package Dimensions" section for variations. (11)				I <sub>T(RMS)</sub> MAX	I <sub>T(AV)</sub> MAX	Volts MIN	μAmps MAX	T <sub>C</sub> = 25 °C MAX	T <sub>C</sub> = 110 °C MAX	Volts MAX
6 A	S2006LS2	S2006FS21	S2006VS2	S2006DS2	6	3.8	200	200	5	250	1.6
	S4006LS2	S4006FS21	S4006VS2	S4006DS2	6	3.8	400	200	5	250	1.6
	S6006LS2	S6006FS21	S6006VS2	S6006DS2	6	3.8	600	200	5	250	1.6
	S2006LS3	S2006FS31	S2006VS3	S2006DS3	6	3.8	200	500	5	250	1.6
	S4006LS3	S4006FS31	S4006VS3	S4006DS3	6	3.8	400	500	5	250	1.6
	S6006LS3	S6006FS31	S6006VS3	S6006DS3	6	3.8	600	500	5	250	1.6
8 A	S2008LS2	S2008FS21	S2008VS2	S2008DS2	8	5.1	200	200	5	250	1.6
	S4008LS2	S4008FS21	S4008VS2	S4008DS2	8	5.1	400	200	5	250	1.6
	S6008LS2	S6008FS21	S6008VS2	S6008DS2	8	5.1	600	200	5	250	1.6
	S2008LS3	S2008FS31	S2008VS3	S2008DS3	8	5.1	200	500	5	250	1.6
	S4008LS3	S4008FS31	S4008VS3	S4008DS3	8	5.1	400	500	5	250	1.6
	S6008LS3	S6008FS31	S6008VS3	S6008DS3	8	5.1	600	500	5	250	1.6
10 A	S2010LS2	S2010FS21	S2010VS2	S2010DS2	10	6.4	200	200	5	250	1.6
	S4010LS2	S4010FS21	S4010VS2	S4010DS2	10	6.4	400	200	5	250	1.6
	S6010LS2	S6010FS21	S6010VS2	S6010DS2	10	6.4	600	200	5	250	1.6
	S2010LS3	S2010FS31	S2010VS3	S2010DS3	10	6.4	200	500	5	250	1.6
	S4010LS3	S4010FS31	S4010VS3	S4010DS3	10	6.4	400	500	5	250	1.6
	S6010LS3	S6010FS31	S6010VS3	S6010DS3	10	6.4	600	500	5	250	1.6

**Specific Test Conditions**

- di/dt** — Maximum rate-of-change of on-state current; I<sub>GT</sub> = 50 mA pulse width ≥15 μsec with ≤0.1 μs rise time
- dv/dt** — Critical rate-of-rise of forward off-state voltage
- I<sup>2</sup>t** — RMS surge (non-repetitive) on-state current for period of 8.3 ms for fusing
- I<sub>DRM</sub> and I<sub>R<sub>RRM</sub></sub>** — Peak off-state current at V<sub>DRM</sub> and V<sub>R<sub>RRM</sub></sub>
- I<sub>GT</sub>** — DC gate trigger current V<sub>D</sub> = 6 V dc; R<sub>L</sub> = 100 Ω
- I<sub>GM</sub>** — Peak gate current
- I<sub>H</sub>** — DC holding current; initial on-state current = 20 mA
- I<sub>T</sub>** — Maximum on-state current
- I<sub>TSM</sub>** — Peak one-cycle forward surge current
- P<sub>G(AV)</sub>** — Average gate power dissipation
- P<sub>GM</sub>** — Peak gate power dissipation
- t<sub>gt</sub>** — Gate controlled turn-on time gate pulse = 10 mA; minimum width = 15 μS with rise time ≤0.1 μs
- t<sub>q</sub>** — Circuit commutated turn-off time
- V<sub>DRM</sub> and V<sub>R<sub>RRM</sub></sub>** — Repetitive peak off-state forward and reverse voltage
- V<sub>GRM</sub>** — Peak reverse gate voltage
- V<sub>GT</sub>** — DC gate trigger voltage; V<sub>D</sub> = 6 V dc; R<sub>L</sub> = 100 Ω
- V<sub>TM</sub>** — Peak on-state voltage







**General Notes**

- Teccor 2N5064 and 2N6565 Series devices conform to all JEDEC registered data. See specifications table on pages E5 - 2 and E5 - 3.
- The case lead temperature (T<sub>C</sub> or T<sub>L</sub>) is measured as shown on dimensional outline drawings in the "Package Dimensions" section of this catalog.
- All measurements (except I<sub>GT</sub>) are made with an external resistor R<sub>GK</sub> = 1 kΩ unless otherwise noted.
- All measurements are made at 60 Hz with a resistive load at an ambient temperature of +25 °C unless otherwise specified.
- Operating temperature (T<sub>J</sub>) is -65 °C to +110 °C for EC Series devices, -65 °C to +125 °C for 2N Series devices, -40 °C to +125 °C for "TCR" Series, and -40 °C to +110 °C for all others.
- Storage temperature range (T<sub>S</sub>) is -65 °C to +150 °C for TO-92 devices, -40 °C to +150 °C for TO-202 and Compak devices, and -40 °C to +125 °C for all others.
- Lead solder temperature is a maximum of +230 °C for 10 seconds maximum ≥1/16" (1.59 mm) from case.

V <sub>GT</sub>			I <sub>H</sub>	I <sub>GM</sub>	V <sub>GRM</sub>	P <sub>GM</sub>	P <sub>G(AV)</sub>	I <sub>TSM</sub>	dv/dt	di/dt	t <sub>gt</sub>	t <sub>q</sub>	I <sup>2</sup> t
(4) (12) (22)			(5) (19)	(17)		(17)		(6) (13)			(8)	(9)	
Volts									Volts/μSec				
T <sub>C</sub> = -40 °C	T <sub>C</sub> = 25 °C	T <sub>C</sub> = 110 °C	mAmps	Amps	Volts	Watts	Watts	Amps	T <sub>C</sub> = 110 °C	Amps/μSec	μSec	μSec	Amps <sup>2</sup> Sec
MAX			MAX		MIN			60/50 Hz	TYP		TYP	MAX	
1	0.8	0.25	6	1	6	1	0.1	100/83	10	100	4	50	41
1	0.8	0.25	6	1	6	1	0.1	100/83	8	100	4	50	41
1	0.8	0.25	6	1	6	1	0.1	100/83	8	100	4	50	41
1	0.8	0.25	8	1	6	1	0.1	100/83	10	100	5	45	41
1	0.8	0.25	8	1	6	1	0.1	100/83	8	100	5	45	41
1	0.8	0.25	8	1	6	1	0.1	100/83	8	100	5	45	41
1	0.8	0.25	6	1	6	1	0.1	100/83	10	100	4	50	41
1	0.8	0.25	6	1	6	1	0.1	100/83	8	100	4	50	41
1	0.8	0.25	6	1	6	1	0.1	100/83	8	100	4	50	41
1	0.8	0.25	8	1	6	1	0.1	100/83	10	100	5	45	41
1	0.8	0.25	8	1	6	1	0.1	100/83	8	100	5	45	41
1	0.8	0.25	8	1	6	1	0.1	100/83	8	100	5	45	41
1	0.8	0.25	6	1	6	1	0.1	100/83	10	100	4	50	41
1	0.8	0.25	6	1	6	1	0.1	100/83	8	100	4	50	41
1	0.8	0.25	6	1	6	1	0.1	100/83	8	100	4	50	41
1	0.8	0.25	8	1	6	1	0.1	100/83	10	100	5	45	41
1	0.8	0.25	8	1	6	1	0.1	100/83	8	100	5	45	41
1	0.8	0.25	8	1	6	1	0.1	100/83	8	100	5	45	41

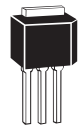
## Electrical Specifications Notes

- (1) See Figure E5.1 through Figure E5.9 for current ratings at specified operating temperatures.
- (2) See Figure E5.10 for I<sub>GT</sub> versus T<sub>C</sub> or T<sub>L</sub>.
- (3) See Figure E5.11 for instantaneous on-state current (I<sub>T</sub>) versus on-state voltage (V<sub>T</sub>) TYP.
- (4) See Figure E5.12 for V<sub>GT</sub> versus T<sub>C</sub> or T<sub>L</sub>.
- (5) See Figure E5.13 for I<sub>H</sub> versus T<sub>C</sub> or T<sub>L</sub>.
- (6) For more than one full cycle, see Figure E5.14.
- (7) 0.8 A to 4 A devices also have a pulse peak forward current on-state rating (repetitive) of 75 A. This rating applies for operation at 60 Hz, 75 °C maximum tab (or anode) lead temperature, switching from 80 V peak, sinusoidal current pulse width of 10 μs minimum, 15 μs maximum. See Figure E5.20 and Figure E5.21.
- (8) See Figure E5.15 for t<sub>gt</sub> versus I<sub>GT</sub>.
- (9) Test conditions as follows:
  - T<sub>C</sub> or T<sub>L</sub> ≤ 80 °C, rectangular current waveform
  - Rate-of-rise of current ≤ 10 A/μs
  - Rate-of-reversal of current ≤ 5 A/μs
  - I<sub>TM</sub> = 1 A (50 μs pulse), Repetition Rate = 60 pps
  - V<sub>RRM</sub> = Rated
  - V<sub>R</sub> = 15 V minimum, V<sub>DRM</sub> = Rated
  - Rate-of-rise reapplied forward blocking voltage = 5 V/μs
  - Gate Bias = 0 V, 100 Ω (during turn-off time interval)
- (10) Test condition is maximum rated RMS current except TO-92 devices are 1.2 A<sub>PK</sub>; T106/T107 devices are 4 A<sub>PK</sub>.
- (11) See package outlines for lead form configurations. When ordering special lead forming, add type number as suffix to part number.
- (12) V<sub>D</sub> = 6 V dc, R<sub>L</sub> = 100 Ω (See Figure E5.19 for simple test circuit for measuring gate trigger voltage and gate trigger current.)
- (13) See Figure E5.1 through Figure E5.9 for maximum allowable case temperature at maximum rated current.
- (14) I<sub>GT</sub> = 500 μA maximum at T<sub>C</sub> = -40 °C for T106 devices
- (15) I<sub>H</sub> = 10 mA maximum at T<sub>C</sub> = -65 °C for 2N5064 Series and 2N6565 Series devices
- (16) I<sub>H</sub> = 6 mA maximum at T<sub>C</sub> = -40 °C for T106 devices
- (17) Pulse Width ≤ 10 μs
- (18) I<sub>GT</sub> = 350 μA maximum at T<sub>C</sub> = -65 °C for 2N5064 Series and 2N6565 Series devices
- (19) Latching current can be higher than 20 mA for higher I<sub>GT</sub> types. Also, latching current can be much higher at -40 °C. See Figure E5.18.
- (20) T<sub>C</sub> or T<sub>L</sub> = T<sub>J</sub> for test conditions in off state
- (21) I<sub>DRM</sub> and I<sub>RRM</sub> = 50 μA for 2N5064 and 100 μA for 2N6565 at 125 °C
- (22) TO-92 devices specified at -65 °C instead of -40 °C
- (23) T<sub>C</sub> = 110 °C

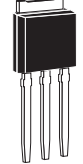
Thermal Resistance (Steady State) $R_{\theta JC}$ [ $R_{\theta JA}$ ] °C/W (TYPICAL)							
Package Code	E	L	F2	F	C	D	V
Type	 TO-92	 TO-220	 TO-202 Type 2, 4, & 41	 TO-202 Type 1 & 3	 Compak	 TO-252 D-Pak	 TO-251 V-Pak
0.8 A	75 [160]				60*		
1.5 A	50 [160]						
4.0 A			10 [100]	6.2 [80]		3.0	3.8 [85]
6.0 A		4.0 [65]		4.3		1.8	2.4
8.0 A		3.4		3.9		1.5	2.1
10.0 A		3.0		3.4		1.45	1.72

\*Mounted on 1 cm<sup>2</sup> copper foil surface; two-ounce copper foil

### Electrical Isolation

Tecor's isolated sensitive SCRs will withstand a minimum high potential test of 2500 V ac rms from leads to mounting tab over the device's operating temperature range. The following table shows other standard and optional isolation ratings.

Electrical Isolation * from Leads to Mounting Tab	
V AC RMS	TO-220
2500	Standard
4000	Optional **

\*UL Recognized File #E71639

\*\*For 4000 V isolation, use "V" suffix in part number.

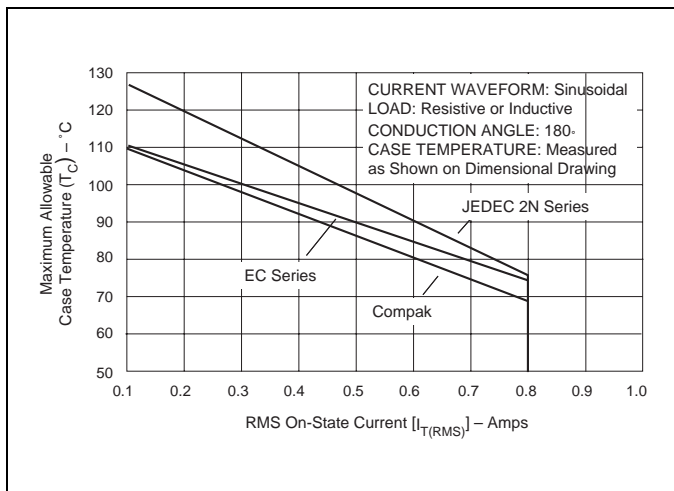

Figure E5.1 Maximum Allowable Case Temperature versus RMS On-state Current

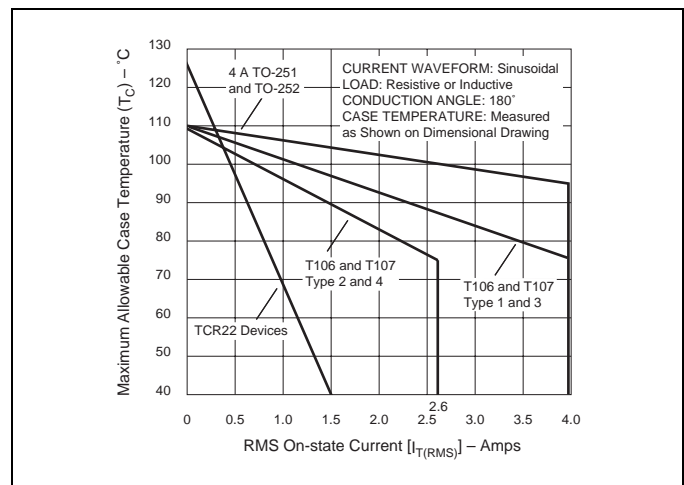

Figure E5.2 Maximum Allowable Case Temperature versus RMS On-state Current

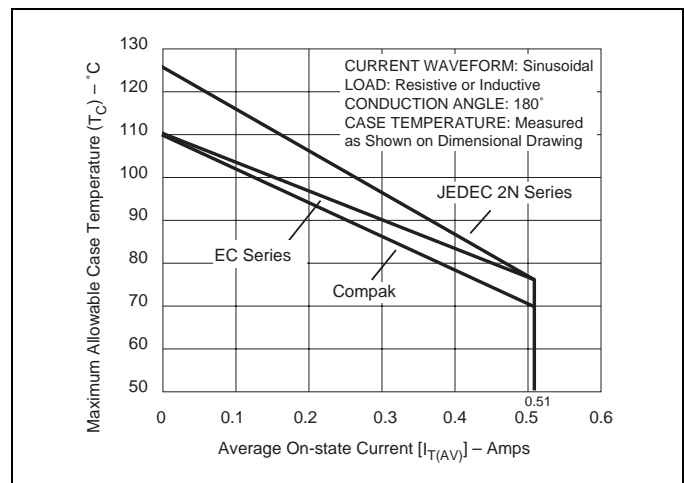

Figure E5.3 Maximum Allowable Case Temperature versus Average On-state Current

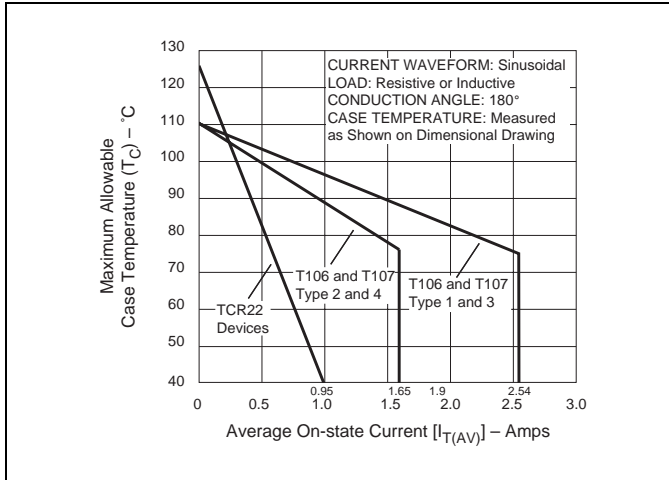

Figure E5.4 Maximum Allowable Case Temperature versus Average On-state Current

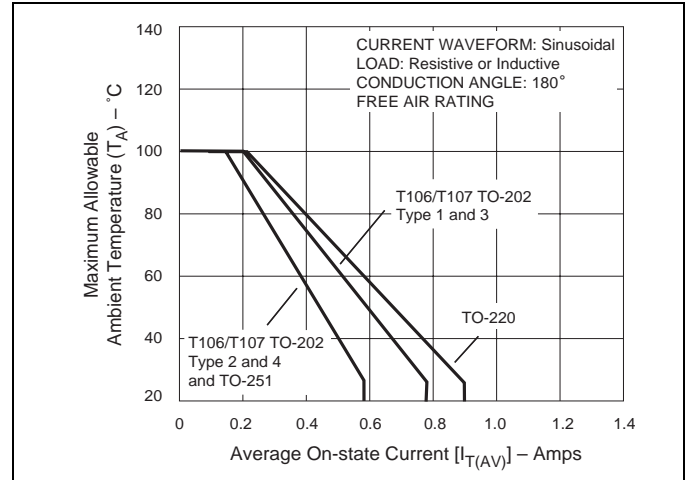

Figure E5.7 Maximum Allowable Ambient Temperature versus Average On-state Current

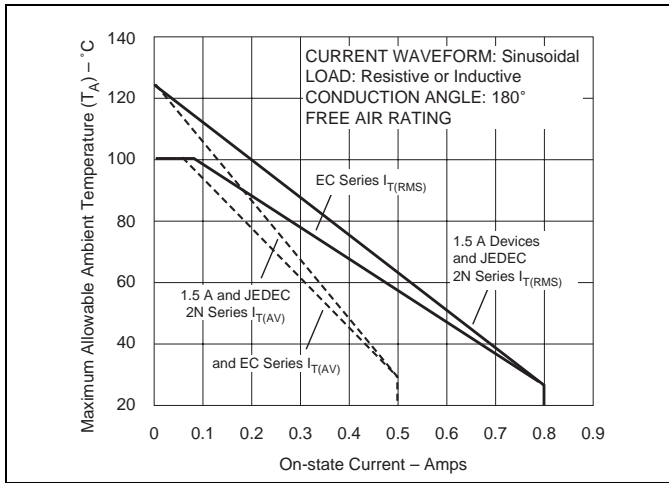

Figure E5.5 Maximum Allowable Ambient Temperature versus On-state Current

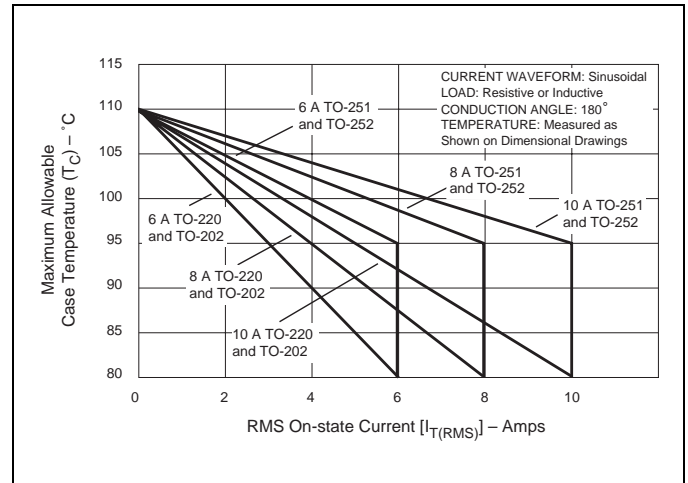

Figure E5.8 Maximum Allowable Case Temperature versus RMS On-state Current

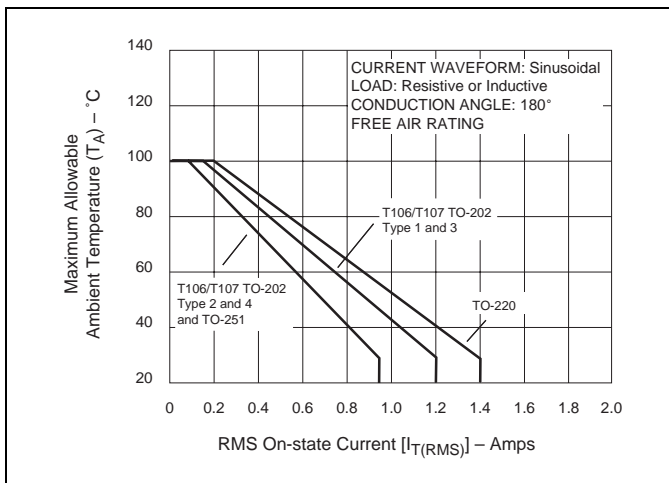

Figure E5.6 Maximum Allowable Ambient Temperature versus RMS On-state Current

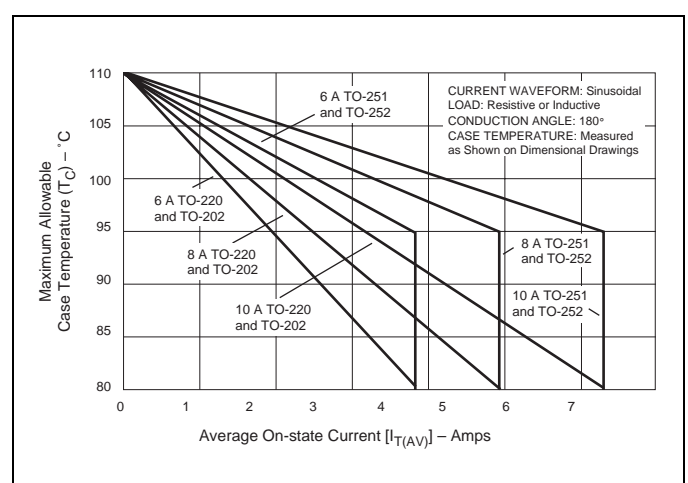

Figure E5.9 Maximum Allowable Case Temperature versus Average On-state Current

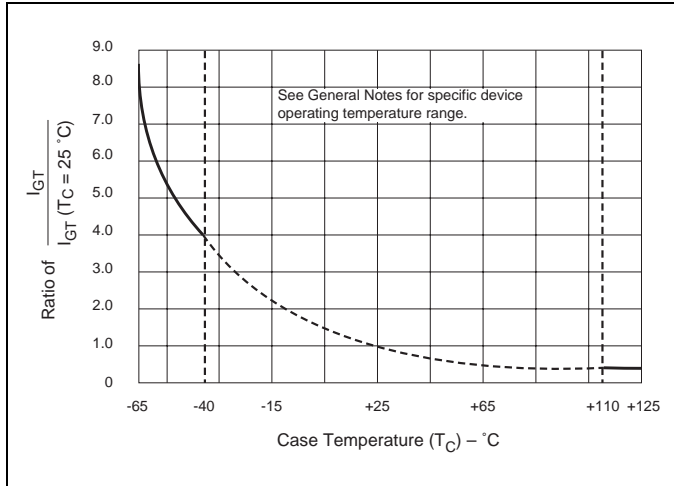

Figure E5.10 Normalized DC Gate-Trigger Current versus Case Temperature

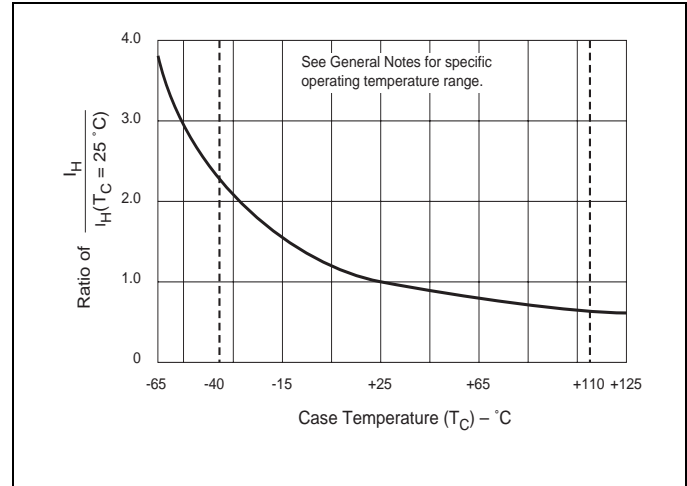

Figure E5.13 Normalized DC Holding Current versus Case Temperature

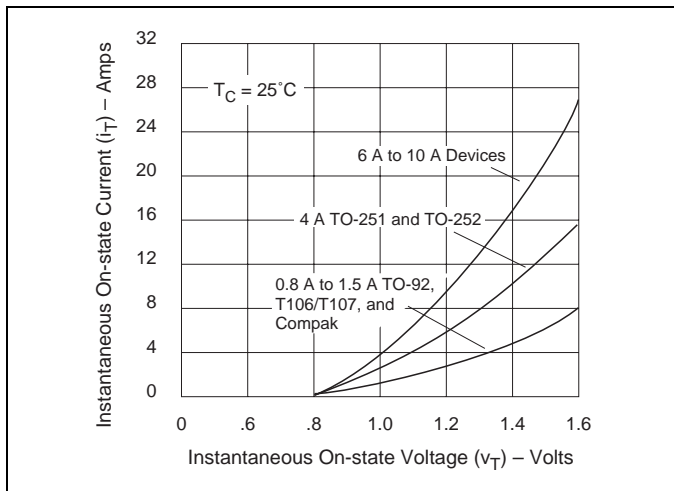

Figure E5.11 Instantaneous On-state Current versus On-state Voltage (Typical)

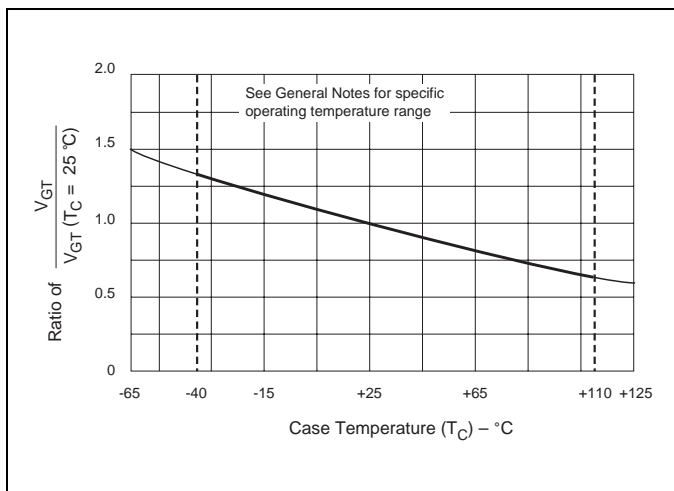

Figure E5.12 Normalized DC Gate-Trigger Voltage versus Case Temperature



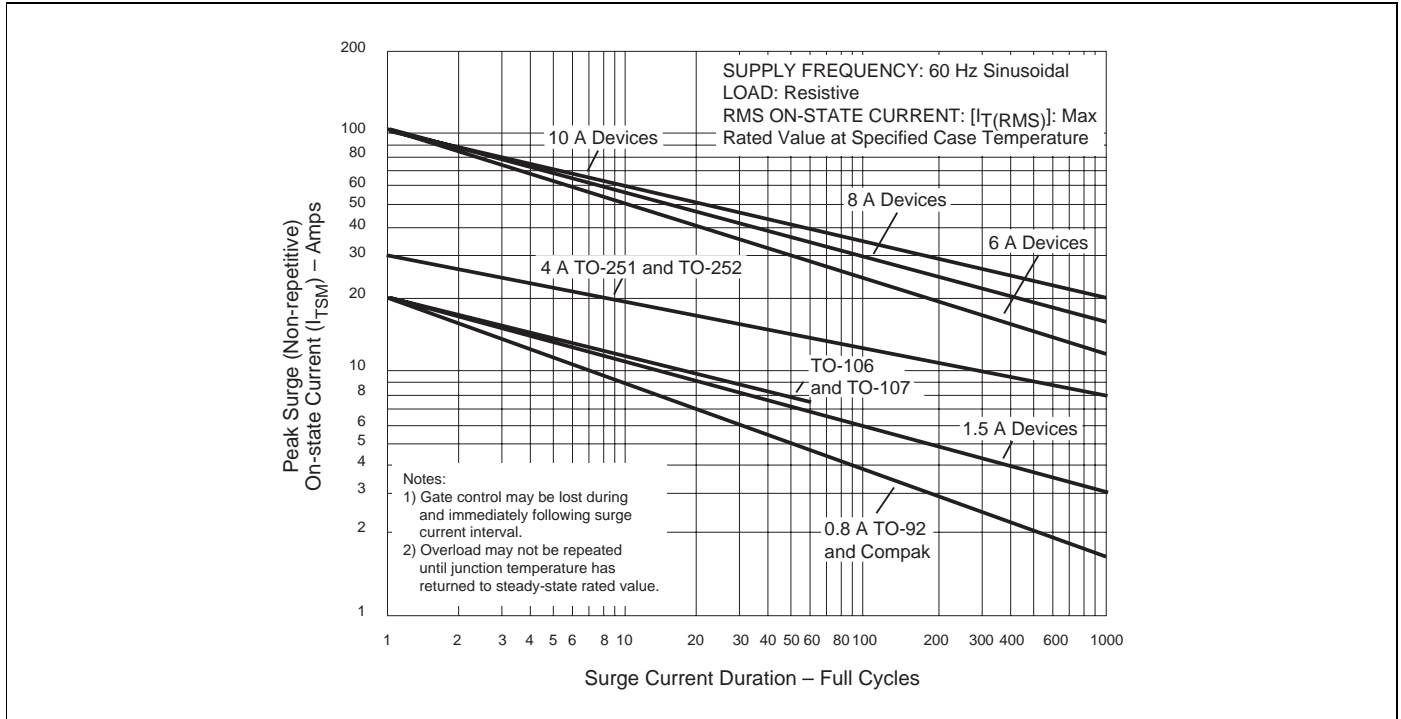

Figure E5.14 Peak Surge On-state Current versus Surge Current Duration

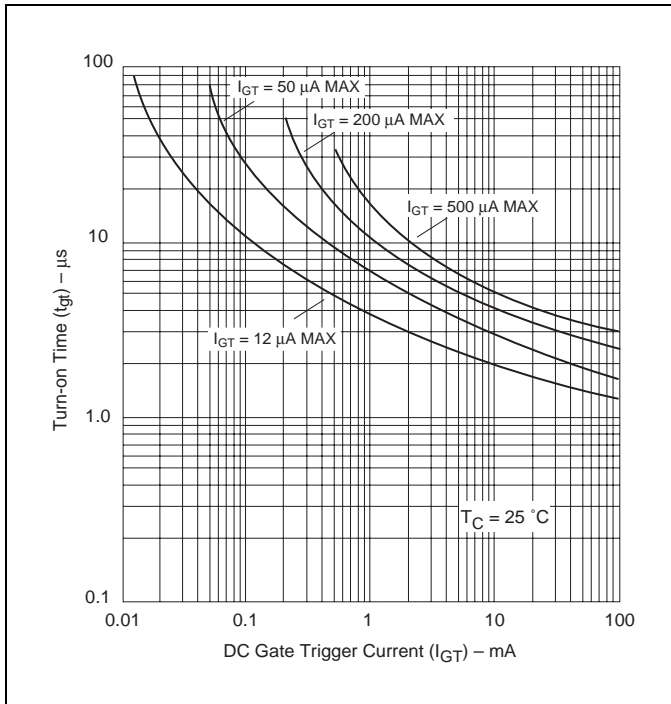

Figure E5.15 Typical Turn-on Time versus Gate Trigger Current

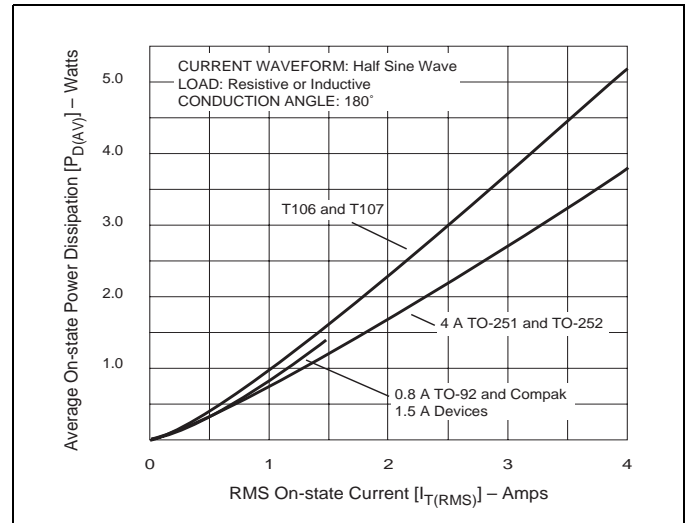

Figure E5.16 Power Dissipation (Typical) versus RMS On-state Current

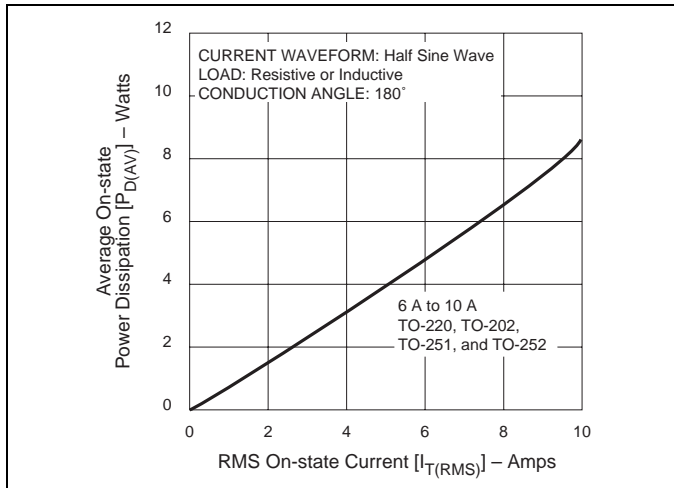

Figure E5.17 Power Dissipation (Typical) versus RMS On-state Current

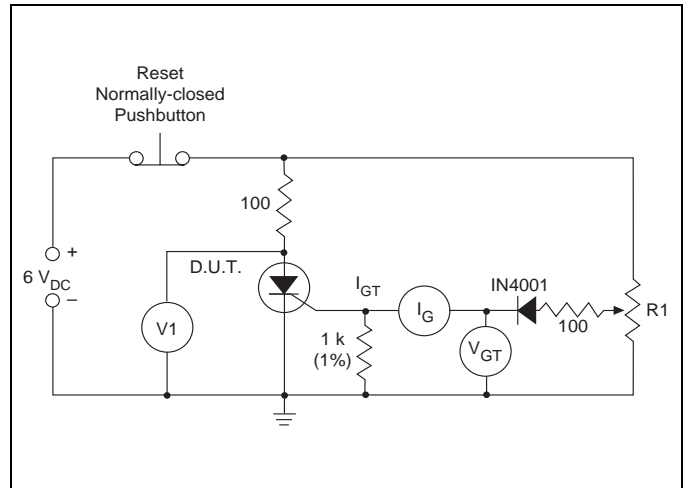

Figure E5.19 Simple Test Circuit for Gate Trigger Voltage and Current Measurement

- Note: V1 — 0 V to 10 V dc meter  
 V<sub>GT</sub> — 0 V to 1 V dc meter  
 I<sub>G</sub> — 0 mA to 1 mA dc milliammeter  
 R1 — 1 k potentiometer

To measure gate trigger voltage and current, raise gate voltage (V<sub>GT</sub>) until meter reading V1 drops from 6 V to 1 V. Gate trigger voltage is the reading on V<sub>GT</sub> just prior to V1 dropping. Gate trigger current I<sub>GT</sub> can be computed from the relationship

$$I_{GT} = I_G - \frac{V_{GT}}{1000} \text{ Amps}$$

where I<sub>G</sub> is reading (in amperes) on meter just prior to V1 dropping.

Note: I<sub>GT</sub> may turn out to be a negative quantity (trigger current flows out from gate lead). If negative current occurs, I<sub>GT</sub> value is not a valid reading. Remove 1 k resistor and use I<sub>G</sub> as the more correct I<sub>GT</sub> value. This will occur on 12 μA gate products.

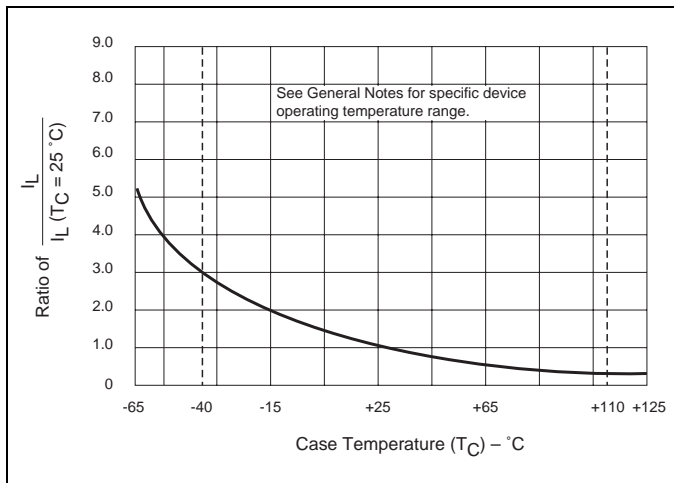

Figure E5.18 Normalized DC Latching Current versus Case Temperature

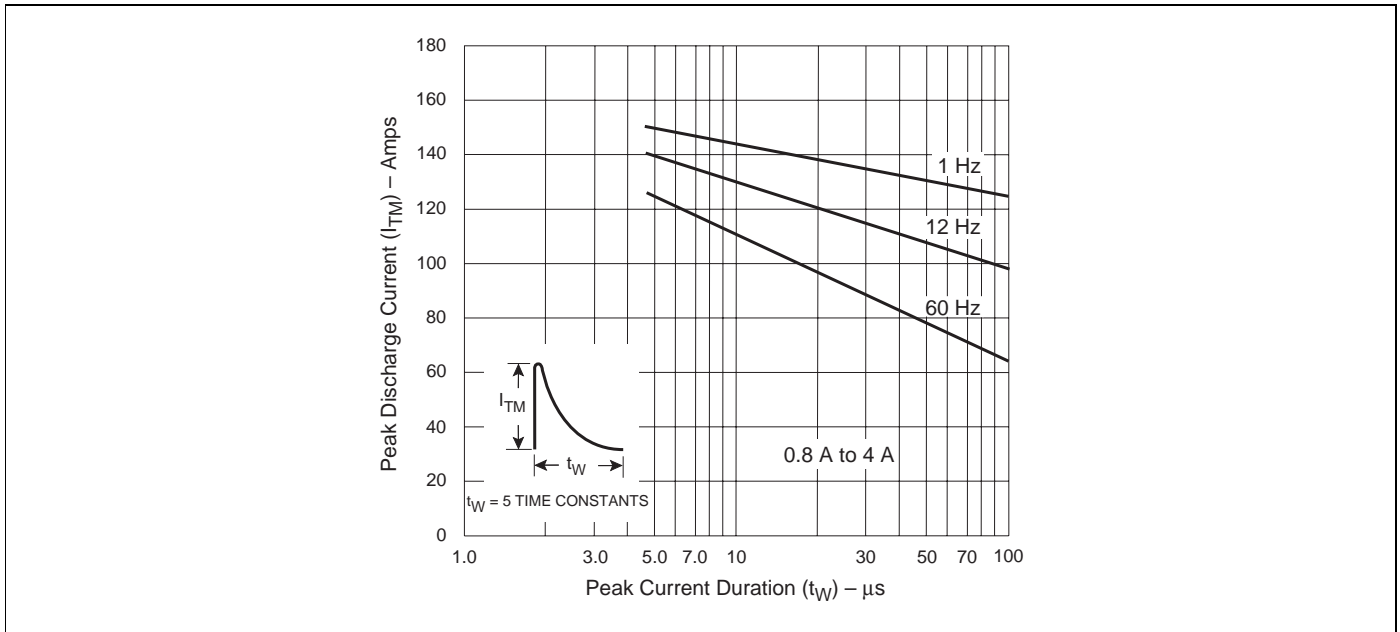

Figure E5.20 Peak Repetitive Capacitor Discharge Current

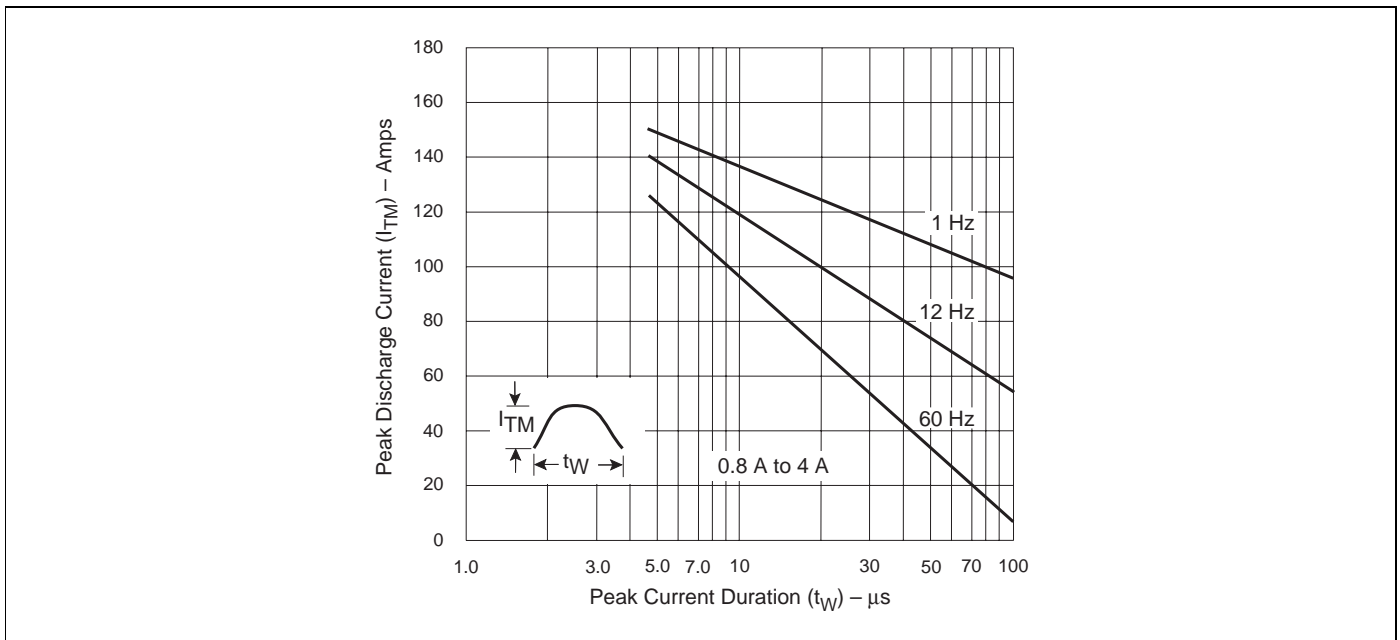

Figure E5.21 Peak Repetitive Sinusoidal Curve

