

2N5401

Rev.F Mar-2016

描述 / Descriptions

TO-92 塑封封装 PNP 半导体三极管。Silicon PNP transistor in a TO-92 Plastic Package.

特征 / Features

击穿电压高,可与 2N5551 互补。

High voltages, complementary pair with 2N5551.

用途 / Applications

用于普通高压放大。

General purpose high voltage amplifier.

内部等效电路 / Equivalent Circuit



引脚排列 / Pinning



PIN 1 : Collector PIN 2 : Base PIN 3 : Emitter

放大及印章代码 / h_{FE} Classifications & Marking

| h_{FE} Classifications Symbol | A | B | C |
|---------------------------------|--------|---------|---------|
| h_{FE} Range | 50~150 | 100~300 | 200~400 |

极限参数 / Absolute Maximum Ratings(Ta=25°C)

| 参数 Parameter | 符号 Symbol | 数值 Rating | 单位 Unit |
|--------------------------------|--------------|--------------|------------|
| Collector to Base Voltage | V_{CBO} | -180 | V |
| Collector to Emitter Voltage | V_{CEO} | -160 | V |
| Emitter to Base Voltage | V_{EBO} | -6.0 | V |
| Collector Current - Continuous | I_C | -600 | mA |
| Base Current - Continuous | I_B | -300 | mA |
| Collector Power Dissipation | P_C | 625 | mW |
| Junction Temperature | T_j | 150 | °C |
| Storage Temperature Range | T_{stg} | -55~150 | °C |

电性能参数 / Electrical Characteristics(Ta=25°C)

| 参数 Parameter | 符号 Symbol | 测试条件 Test Conditions | 最小值 Min | 典型值 Typ | 最大值 Max | 单位 Unit |
|-----------------------------------------|------------------|----------------------------------------|------------|------------|------------|------------|
| Collector Cut-Off Current | I_{CBO} | $V_{CB}=-180V$ $I_E=0$ | | | -0.1 | μA |
| Emitter Cut-Off Current | I_{EBO} | $V_{EB}=-6.0V$ $I_C=0$ | | | -0.1 | μA |
| DC Current Gain | $h_{FE(1)}$ | $V_{CE}=-5.0V$ $I_C=-10mA$ | 50 | | 400 | |
| | $h_{FE(2)}$ | $V_{CE}=-5.0V$ $I_C=-50mA$ | 20 | | | |
| | $h_{FE(3)}$ | $V_{CE}=-5.0V$ $I_C=-1.0mA$ | 40 | | | |
| Collector to Emitter Saturation Voltage | $V_{CE(sat)(1)}$ | $I_C=-10mA$ $I_B=-1.0mA$ | | -0.12 | -0.4 | V |
| | $V_{CE(sat)(2)}$ | $I_C=-50mA$ $I_B=-5.0mA$ | | -0.5 | -0.8 | V |
| Base to Emitter Saturation Voltage | $V_{BE(sat)(1)}$ | $I_C=-10mA$ $I_B=-1.0mA$ | | -0.75 | -1.0 | V |
| | $V_{BE(sat)(2)}$ | $I_C=-50mA$ $I_B=-5.0mA$ | | -0.8 | -1.0 | V |
| Base to Emitter Voltage | V_{BE} | $V_{CE}=-5.0V$ $I_C=-10mA$ | | -0.7 | -0.75 | V |
| Current Gain Bandwidth Product | f_T | $V_{CE}=-10V$ $I_C=-10mA$ | 50 | 80 | | MHz |
| Output Capacitance | C_{ob} | $V_{CB}=-10V$ $I_E=0$ $f=10MHz$ | | 2.5 | 5.0 | pF |
| Turn On Time | t_{on} | $I_C=-100mA$ $-I_{B1}=I_{B2}=-10mA$ | | 0.1 | | μs |
| Turn Off Time | t_{off} | $I_C=-100mA$ $-I_{B1}=I_{B2}=-10mA$ | | 0.2 | | μs |
| Storage Time | t_{stg} | $I_C=-100mA$ $-I_{B1}=I_{B2}=-10mA$ | | 0.1 | | μs |

电参数曲线图 / Electrical Characteristic Curve

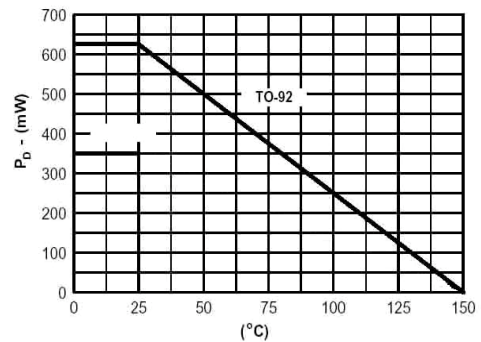
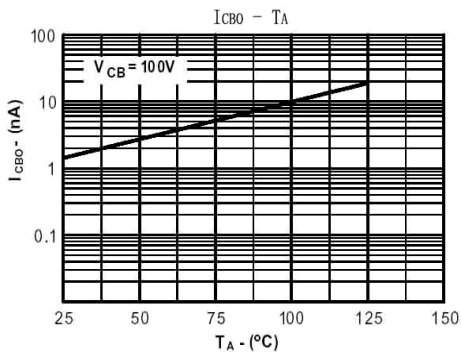
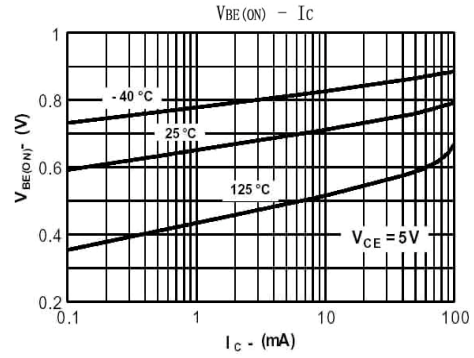
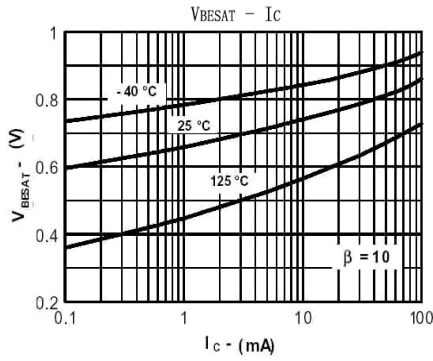
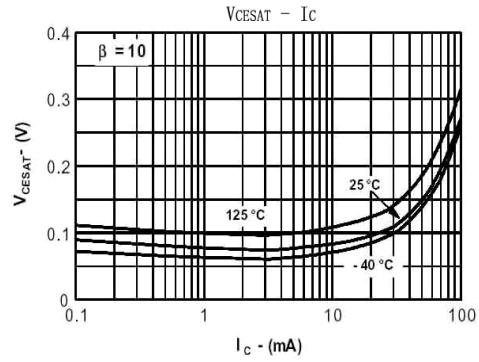
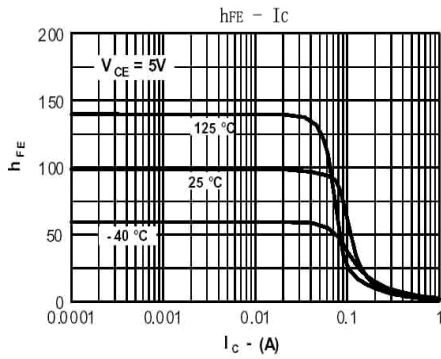

外形尺寸图 / Package Dimensions

TO-92

Unit: mm

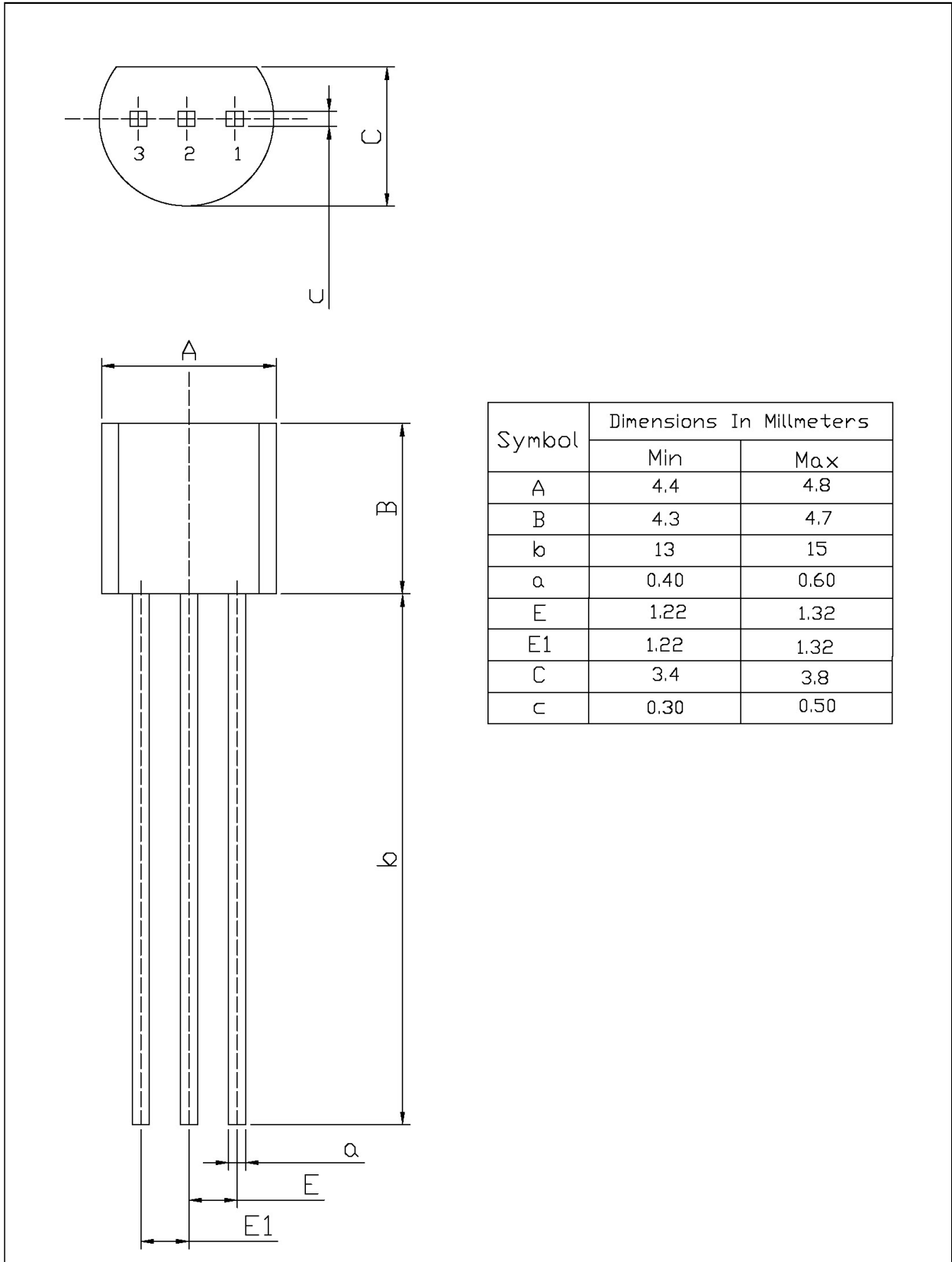

| Symbol | Dimensions In Millimeters | |
|--------|---------------------------|------|
| | Min | Max |
| A | 4.4 | 4.8 |
| B | 4.3 | 4.7 |
| b | 13 | 15 |
| a | 0.40 | 0.60 |
| E | 1.22 | 1.32 |
| E1 | 1.22 | 1.32 |
| C | 3.4 | 3.8 |
| c | 0.30 | 0.50 |

印章说明 / Marking Instructions

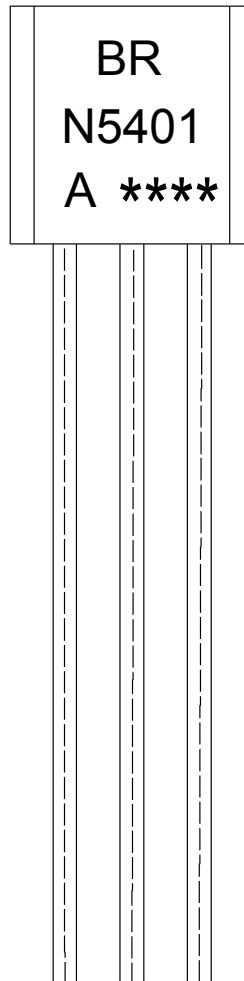

说明：

BR： 为公司代码

N5401： 为型号代码

A： 为 h_{FE} 分档代码

****： 为生产批号代码，随生产批号变化。

Note:

BR: Company Code.

N5401: Product Type.

A: h_{FE} Classifications Symbol.

****: Lot No. Code, code change with Lot No.

波峰焊温度曲线图(无铅) / Temperature Profile for Dip Soldering(Pb-Free)



说明：

- 1、预热温度 25 ~ 150°C，时间 60 ~ 90sec;
- 2、峰值温度 255±5°C，时间持续为 5±0.5sec;
- 3、焊接制程冷却速度为 2 ~ 10°C/sec.

Note:

- 1.Preheating:25~150°C, Time:60~90sec.
- 2.Peak Temp.:255±5°C, Duration:5±0.5sec.
3. Cooling Speed: 2~10°C/sec.

耐焊接热试验条件 / Resistance to Soldering Heat Test Conditions

温度：270±5°C 时间：10±1 sec. Temp.:270±5°C Time:10±1 sec

包装规格 / Packaging SPEC.

散件包装 / BULK

| Package Type 封装形式 | Units 包装数量 | | | | | Dimension 包装尺寸 (unit: mm3) | | |
|----------------------|------------------|-----------------------|------------------------|------------------------------|------------------------|----------------------------|-------------|-------------|
| | Units/Bag 只/袋 | Bags/Inner Box 袋/盒 | Units/Inner Box 只/盒 | Inner Boxes/Outer Box 盒/箱 | Units/Outer Box 只/箱 | Bag 袋 | Inner Box 盒 | Outer Box 箱 |
| TO-92 | 1,000 | 10 | 10,000 | 5 | 50,000 | 135×190 | 237×172×102 | 560×245×195 |
| | 1,000 | 10 | 10,000 | 10 | 100,000 | 135×190 | 237×172×102 | 560×245×375 |

编带包装 / AMMO

| Package Type 封装形式 | Units 包装数量 | | | | | Dimension 包装尺寸 (unit: mm3) | |
|----------------------|--------------------|------------------------|-------------------------|------------------------------|------------------------|----------------------------|-----------------------------------|
| | Units/tape 只/纸带 | Tape/Inner Box 纸带/盒 | Rows/Inner Box 纸带层/盒 | Inner Boxes/Outer Box 盒/箱 | Units/Outer Box 只/箱 | Inner Box 盒 | Outer Box 箱 |
| TO-92 | 3,000 | 1 | 120 | 10 | 30,000 | 328×230×42 | 小箱 480×346×235, 大箱 547×407×268 |

使用说明 / Notices