

High-Power NPN Silicon Transistors

... designed for use in industrial–military power amplifier and switching circuit applications.

- High Collector Emitter Sustaining —
 $V_{CEO(sus)} = 100 \text{ Vdc (Min) — 2N6274}$
 $= 120 \text{ Vdc (Min) — 2N6275}$
 $= 150 \text{ Vdc (Min) — 2N6277}$
- High DC Current Gain —
 $h_{FE} = 30\text{--}120 @ I_C = 20 \text{ Adc}$
 $= 10 \text{ (Min) } @ I_C = 50 \text{ Adc}$
- Low Collector–Emitter Saturation Voltage —
 $V_{CE(sat)} = 1.0 \text{ Vdc (Max) } @ I_C = 20 \text{ Adc}$
- Fast Switching Times @ $I_C = 20 \text{ Adc}$
 $t_r = 0.35 \text{ ms (Max)}$
 $t_s = 0.8 \text{ ms (Max)}$
 $t_f = 0.25 \text{ ms (Max)}$
- Complement to 2N6377–79

2N6274
2N6275
2N6277*

*ON Semiconductor Preferred Device

50 AMPERE
POWER TRANSISTORS
NPN SILICON
100, 120, 140, 150 VOLTS
250 WATTS

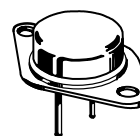

CASE 197A–05
TO–204AE
(TO–3)

MAXIMUM RATINGS(1)

Rating	Symbol	2N6274	2N6275	2N6277	Unit
Collector–Base Voltage	V_{CB}	120	140	180	Vdc
Collector–Emitter Voltage	V_{CEO}	100	120	150	Vdc
Emitter–Base Voltage	V_{EB}	6.0			Vdc
Collector Current — Continuous Peak	I_C	50 100			A dc
Base Current	I_B	20			A dc
Total Device Dissipation @ $T_C = 25^\circ\text{C}$ Derate above 25°C	P_D	250 1.43			Watts W/ $^\circ\text{C}$
Operating and Storage Junction Temperature Range	T_J, T_{stg}	–65 to +200			$^\circ\text{C}$

THERMAL CHARACTERISTIC

Characteristic	Symbol	Max	Unit
Thermal Resistance, Junction to Case	θ_{JC}	0.7	$^\circ\text{C/W}$

(1) Indicates JEDEC Registered Data.

Preferred devices are ON Semiconductor recommended choices for future use and best overall value.

2N6274 2N6275 2N6277

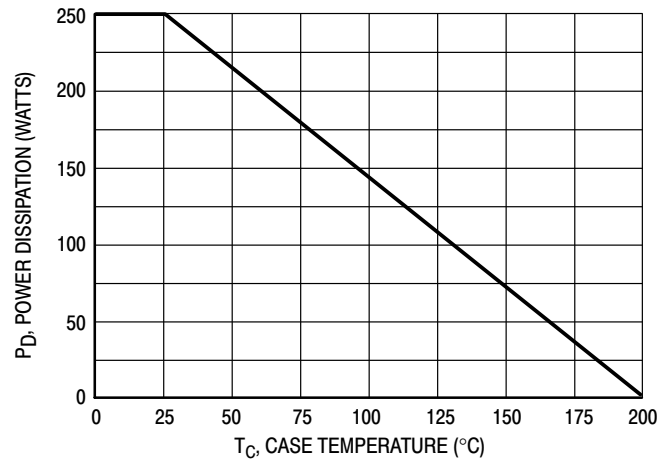

Figure 1. Power Derating

2N6274 2N6275 2N6277

***ELECTRICAL CHARACTERISTICS** ($T_C = 25^\circ\text{C}$ unless otherwise noted)

Characteristic	Symbol	Min	Max	Unit	
OFF CHARACTERISTICS					
Collector–Emitter Sustaining Voltage (2) $I_C = 50 \text{ mAdc}, I_B = 0$	2N6274 2N6275 2N6277	$V_{CEO(sus)}$	100 120 150	— — —	Vdc
Collector Cutoff Current ($V_{CE} = 50 \text{ Vdc}, I_B = 0$) ($V_{CE} = 60 \text{ Vdc}, I_B = 0$) ($V_{CE} = 75 \text{ Vdc}, I_B = 0$)	2N6274 2N6275 2N6277	I_{CEO}	— — —	50 50 50	μAdc
Collector Cutoff Current ($V_{CE} = \text{Rated } V_{CB}, V_{EB(off)} = 1.5 \text{ Vdc}$) ($V_{CE} = \text{Rated } V_{CB}, V_{EB(off)} = 1.5 \text{ Vdc}, T_C = 150^\circ\text{C}$)		I_{CEX}	— —	10 1.0	μAdc mAdc
Emitter Cutoff Current ($V_{BE} = 6.0 \text{ Vdc}, I_C = 0$)		I_{EBO}	—	100	μAdc

ON CHARACTERISTICS (2)

DC Current Gain $I_C = 1.0 \text{ Adc}, V_{CE} = 4.0 \text{ Vdc}$ $I_C = 20 \text{ Adc}, V_{CE} = 4.0 \text{ Vdc}$ $I_C = 50 \text{ Adc}, V_{CE} = 4.0 \text{ Vdc}$		h_{FE}	50 30 10	— 120 —	—
Collector–Emitter Saturation Voltage $I_C = 20 \text{ Adc}, I_B = 2.0 \text{ Adc}$ $I_C = 50 \text{ Adc}, I_B = 10 \text{ Adc}$		$V_{CE(sat)}$	— —	1.0 3.0	Vdc
Base–Emitter Saturation Voltage $I_C = 20 \text{ Adc}, I_B = 2.0 \text{ Adc}$ $I_C = 50 \text{ Adc}, I_B = 10 \text{ Adc}$		$V_{BE(sat)}$	— —	1.8 3.5	Vdc
Base–Emitter On Voltage ($I_C = 20 \text{ Adc}, V_{CE} = 4.0 \text{ Vdc}$)		$V_{BE(on)}$	—	1.8	Vdc

DYNAMIC CHARACTERISTICS

Current–Gain Bandwidth Product (3) ($I_C = 1.0 \text{ Adc}, V_{CE} = 10 \text{ Vdc}, f_{test} = 10 \text{ MHz}$)		f_T	30	—	MHz
Output Capacitance ($V_{CB} = 10 \text{ Vdc}, I_E = 0, f = 0.1 \text{ MHz}$)		C_{ob}	—	600	pF

SWITCHING CHARACTERISTICS

Rise Time ($V_{CC} = 80 \text{ Vdc}, I_C = 20 \text{ Adc}, I_{B1} = 2.0 \text{ Adc}, V_{BE(off)} = 5.0 \text{ Vdc}$)		t_r	—	0.35	μs
Storage Time ($V_{CC} = 80 \text{ Vdc}, I_C = 20 \text{ Adc}, I_{B1} = I_{B2} = 2.0 \text{ Adc}$)		t_s	—	0.80	μs
Fall Time ($V_{CC} = 80 \text{ Vdc}, I_C = 20 \text{ Adc}, I_{B1} = I_{B2} = 2.0 \text{ Adc}$)		t_f	—	0.25	μs

*Indicates JEDEC Registered Data.

(2) Pulse Test: Pulse Width $\leq 300 \mu\text{s}$, Duty Cycle $\leq 2.0\%$.

(3) $f_T = |h_{fe}| \cdot f_{test}$

2N6274 2N6275 2N6277

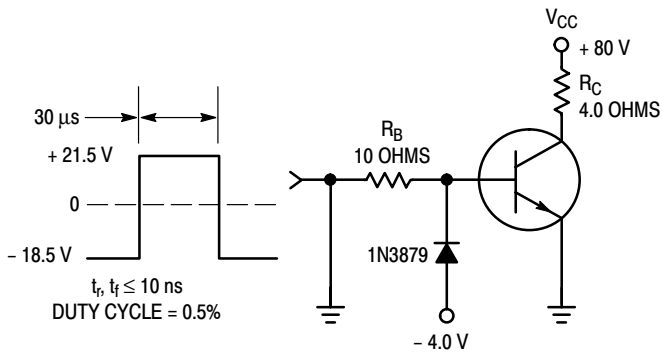

NOTE: For information of Figures 3 and 6, R_B and R_C were varied to obtain desired test conditions.

Figure 2. Switching Time Test Circuit

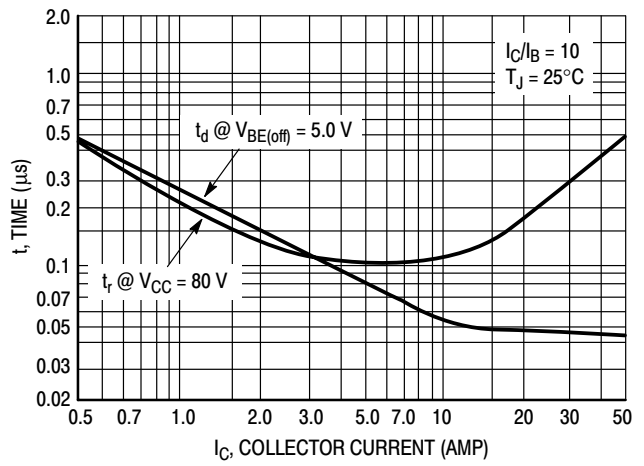

Figure 3. Turn-On Time

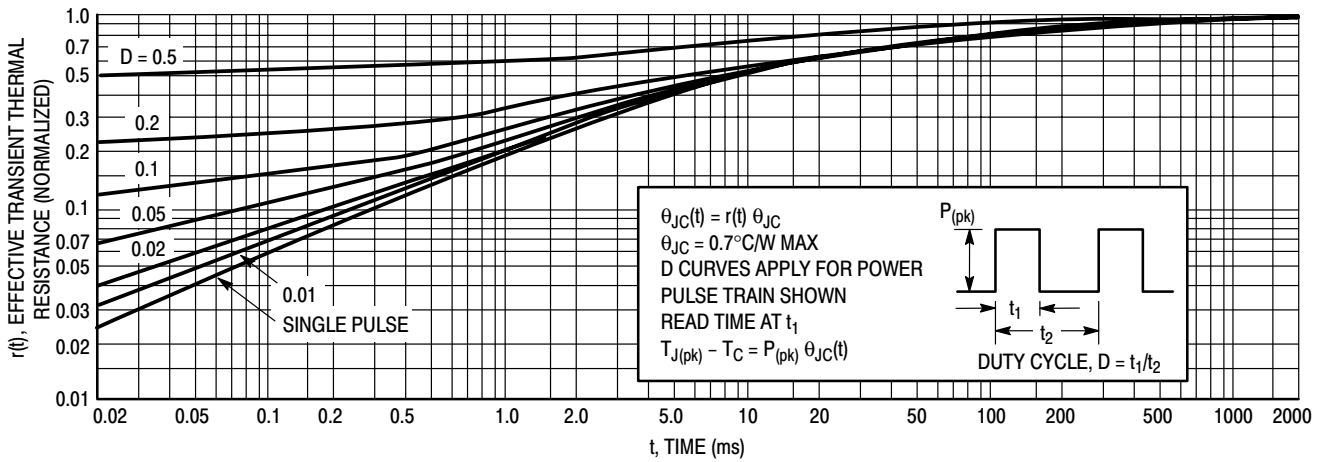

Figure 4. Thermal Response

2N6274 2N6275 2N6277

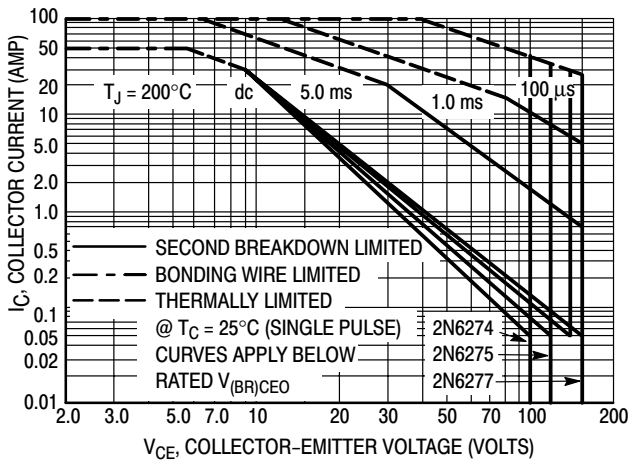

Figure 5. Active-Region Safe Operating Area

There are two limitations on the power handling ability of a transistor: average junction temperature and second breakdown. Safe operating area curves indicate $I_C - V_{CE}$ limits of the transistor that must be observed for reliable operation; i.e., the transistor must not be subjected to greater dissipation than the curves indicate.

The data of Figure 5 is based on $T_{J(pk)} = 200^\circ\text{C}$; T_C is variable depending on conditions. Second breakdown pulse limits are valid for duty cycles to 10% provided $T_{J(pk)} \leq 200^\circ\text{C}$. $T_{J(pk)}$ may be calculated from the data in Figure 4. At high case temperatures, thermal limitations will reduce the power that can be handled to values less than the limitations imposed by second breakdown.

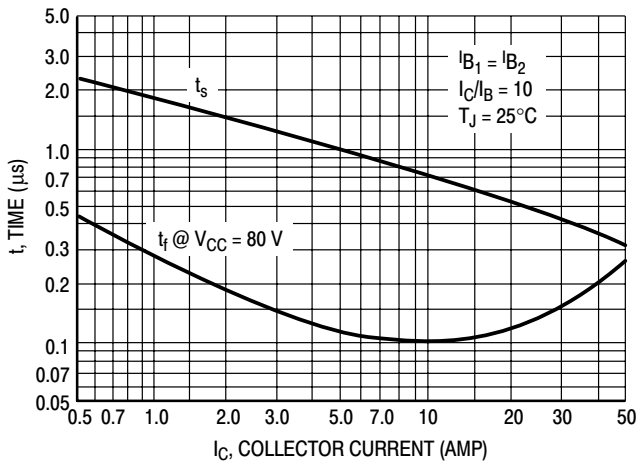

Figure 6. Turn-Off Time

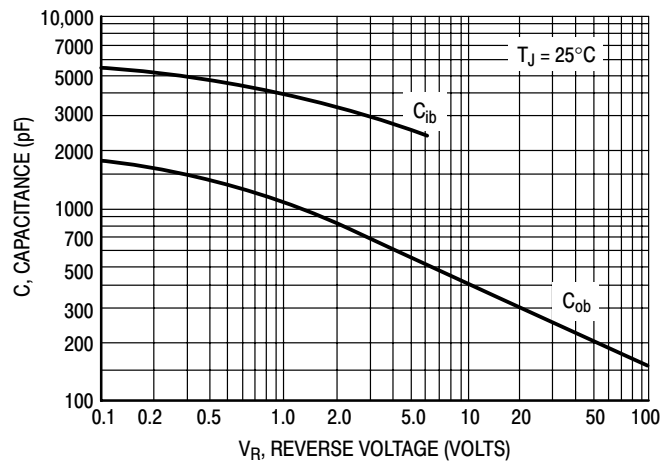

Figure 7. Capacitance

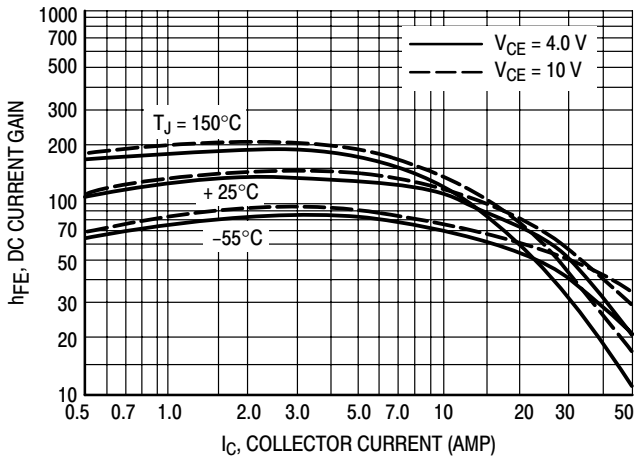

Figure 8. DC Current Gain

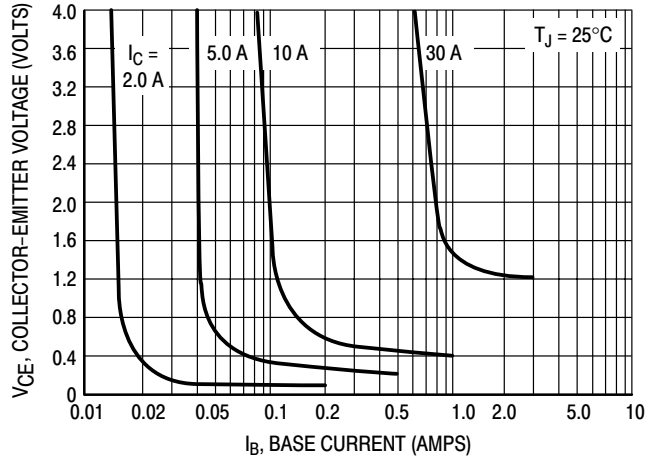

Figure 9. Collector Saturation Region

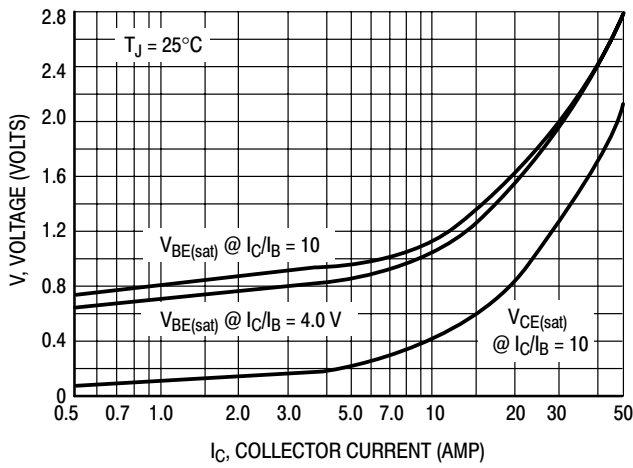

Figure 10. "On" Voltages

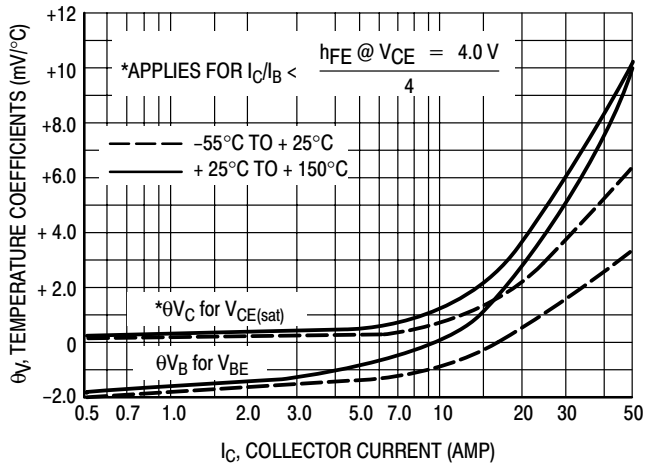

Figure 11. Temperature Coefficients

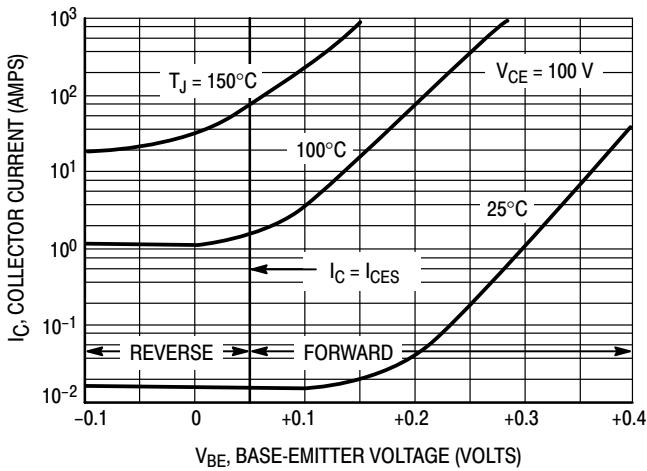

Figure 12. Collector Cut-off Region

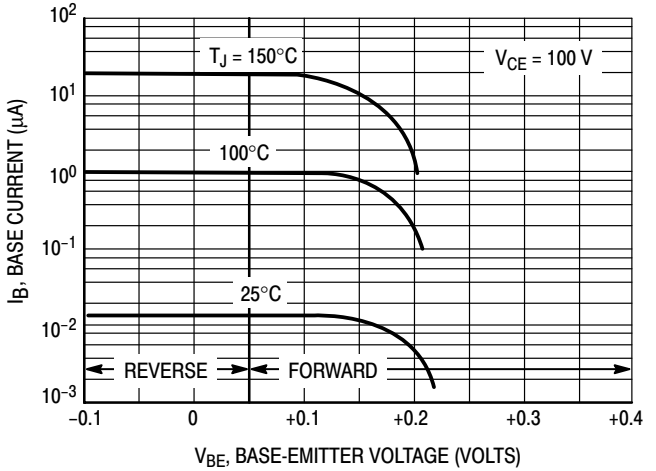
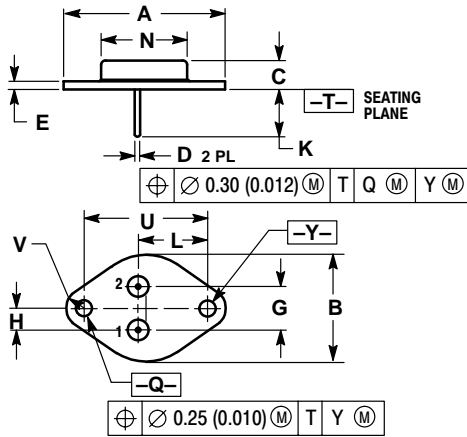

Figure 13. Base Cut-off Region

2N6274 2N6275 2N6277

PACKAGE DIMENSIONS

CASE 197A-05
TO-204AE
ISSUE J



- NOTES:
1. DIMENSIONING AND TOLERANCING PER ANSI Y14.5M, 1982.
2. CONTROLLING DIMENSION: INCH.

DIM	INCHES		MILLIMETERS	
	MIN	MAX	MIN	MAX
A	1.530 REF		38.86 REF	
B	0.990	1.050	25.15	26.67
C	0.250	0.335	6.35	8.51
D	0.057	0.063	1.45	1.60
E	0.060	0.070	1.53	1.77
G	0.430 BSC		10.92 BSC	
H	0.215 BSC		5.46 BSC	
K	0.440	0.480	11.18	12.19
L	0.665 BSC		16.89 BSC	
N	0.760	0.830	19.31	21.08
Q	0.151	0.165	3.84	4.19
U	1.187 BSC		30.15 BSC	
V	0.131	0.188	3.33	4.77

STYLE 1:
PIN 1: BASE
2: EMITTER
CASE: COLLECTOR

ON Semiconductor and  are trademarks of Semiconductor Components Industries, LLC (SCILLC). SCILLC reserves the right to make changes without further notice to any products herein. SCILLC makes no warranty, representation or guarantee regarding the suitability of its products for any particular purpose, nor does SCILLC assume any liability arising out of the application or use of any product or circuit, and specifically disclaims any and all liability, including without limitation special, consequential or incidental damages. "Typical" parameters which may be provided in SCILLC data sheets and/or specifications can and do vary in different applications and actual performance may vary over time. All operating parameters, including "Typicals" must be validated for each customer application by customer's technical experts. SCILLC does not convey any license under its patent rights nor the rights of others. SCILLC products are not designed, intended, or authorized for use as components in systems intended for surgical implant into the body, or other applications intended to support or sustain life, or for any other application in which the failure of the SCILLC product could create a situation where personal injury or death may occur. Should Buyer purchase or use SCILLC products for any such unintended or unauthorized application, Buyer shall indemnify and hold SCILLC and its officers, employees, subsidiaries, affiliates, and distributors harmless against all claims, costs, damages, and expenses, and reasonable attorney fees arising out of, directly or indirectly, any claim of personal injury or death associated with such unintended or unauthorized use, even if such claim alleges that SCILLC was negligent regarding the design or manufacture of the part. SCILLC is an Equal Opportunity/Affirmative Action Employer.

PUBLICATION ORDERING INFORMATION

NORTH AMERICA Literature Fulfillment:

Literature Distribution Center for ON Semiconductor
P.O. Box 5163, Denver, Colorado 80217 USA
Phone: 303-675-2175 or 800-344-3860 Toll Free USA/Canada
Fax: 303-675-2176 or 800-344-3867 Toll Free USA/Canada
Email: ONlit@hibbertco.com
Fax Response Line: 303-675-2167 or 800-344-3810 Toll Free USA/Canada

N. American Technical Support: 800-282-9855 Toll Free USA/Canada

EUROPE: LDC for ON Semiconductor – European Support

German Phone: (+1) 303-308-7140 (Mon-Fri 2:30pm to 7:00pm CET)
Email: ONlit-german@hibbertco.com
French Phone: (+1) 303-308-7141 (Mon-Fri 2:00pm to 7:00pm CET)
Email: ONlit-french@hibbertco.com
English Phone: (+1) 303-308-7142 (Mon-Fri 12:00pm to 5:00pm GMT)
Email: ONlit@hibbertco.com

EUROPEAN TOLL-FREE ACCESS*: 00-800-4422-3781

*Available from Germany, France, Italy, UK, Ireland

CENTRAL/SOUTH AMERICA:

Spanish Phone: 303-308-7143 (Mon-Fri 8:00am to 5:00pm MST)
Email: ONlit-spanish@hibbertco.com
Toll-Free from Mexico: Dial 01-800-288-2872 for Access –
then Dial 866-297-9322

ASIA/PACIFIC: LDC for ON Semiconductor – Asia Support

Phone: 1-303-675-2121 (Tue-Fri 9:00am to 1:00pm, Hong Kong Time)
Toll Free from Hong Kong & Singapore:
001-800-4422-3781
Email: ONlit-asia@hibbertco.com

JAPAN: ON Semiconductor, Japan Customer Focus Center
4-32-1 Nishi-Gotanda, Shinagawa-ku, Tokyo, Japan 141-0031
Phone: 81-3-5740-2700
Email: r14525@onsemi.com

ON Semiconductor Website: <http://onsemi.com>

For additional information, please contact your local Sales Representative.