

Dimensions in mm (inches).

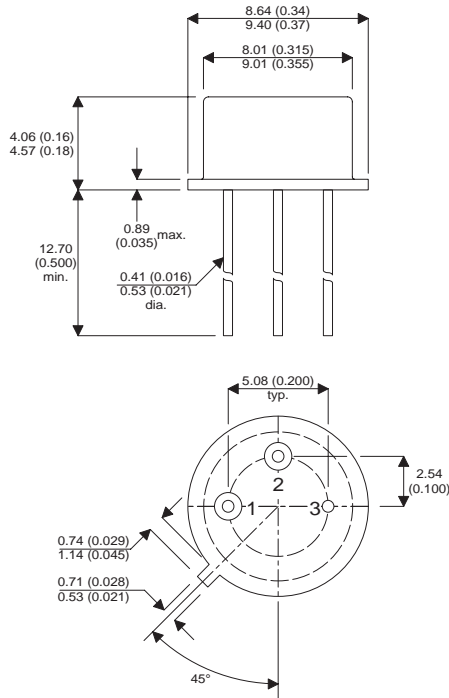

**TO39 (TO205AF)
PINOUTS**

1 – Source 2 – Gate 3 - Drain

**N-Channel MOSFET
in a
Hermetically sealed TO39
Metal Package.**

N-Channel MOSFET.

$V_{DSS} = 200V$

$I_D = 2.25A$

$R_{DS(ON)} = 1.5\Omega$

All Semelab hermetically sealed products can be processed in accordance with the requirements of BS, CECC and JAN, JANTX, JANTXV and JANS specifications.

	Parameter	Min.	Typ.	Max.	Units
V_{DSS}	Drain – Source Breakdown Voltage			200	V
I_D	Continuous Drain Current			2.25	A
P_D	Power Dissipation			15	W
$R_{DS(ON)}$	Static Drain – Source On–State Resistance			1.5	Ω
C_{ISS}	Input Capacitance		140		pF
Q_g	Total Gate Charge			6.2	nC
$t_{td(on)}$	Turn–On Delay Time			15	ns
t_{tr}	Rise Time			20	ns
$t_{td(off)}$	Turn–Off Delay Time			30	ns
t_f	Fall Time			20	ns

This is a shortform datasheet. For a full datasheet please contact sales@semelab.co.uk.

Semelab Plc reserves the right to change test conditions, parameter limits and package dimensions without notice. Information furnished by Semelab is believed to be both accurate and reliable at the time of going to press. However Semelab assumes no responsibility for any errors or omissions discovered in its use.