

# 2N7002L

## Small Signal MOSFET

60 V, 115 mA, N-Channel SOT-23

### Features

- Pb-Free Packages are Available

### MAXIMUM RATINGS

Rating	Symbol	Value	Unit
Drain-Source Voltage	$V_{DS}$	60	Vdc
Drain-Gate Voltage ( $R_{GS} = 1.0 \text{ M}\Omega$ )	$V_{DGR}$	60	Vdc
Drain Current - Continuous $T_C = 25^\circ\text{C}$ (Note 1) $T_C = 100^\circ\text{C}$ (Note 1) - Pulsed (Note 2)	$I_D$ $I_{DM}$	$\pm 115$ $\pm 75$ $\pm 800$	mAdc
Gate-Source Voltage - Continuous - Non-repetitive ( $t_p \leq 50 \mu\text{s}$ )	$V_{GS}$ $V_{GSM}$	$\pm 20$ $\pm 40$	Vdc Vpk

Maximum ratings are those values beyond which device damage can occur. Maximum ratings applied to the device are individual stress limit values (not normal operating conditions) and are not valid simultaneously. If these limits are exceeded, device functional operation is not implied, damage may occur and reliability may be affected.

### THERMAL CHARACTERISTICS

Characteristic	Symbol	Max	Unit
Total Device Dissipation FR-5 Board (Note 3) $T_A = 25^\circ\text{C}$ Derate above $25^\circ\text{C}$	$P_D$	225 1.8	mW mW/ $^\circ\text{C}$
Thermal Resistance, Junction to Ambient	$R_{\theta JA}$	556	$^\circ\text{C}/\text{W}$
Total Device Dissipation Alumina Substrate, (Note 4) $T_A = 25^\circ\text{C}$ Derate above $25^\circ\text{C}$	$P_D$	300 2.4	mW mW/ $^\circ\text{C}$
Thermal Resistance, Junction to Ambient	$R_{\theta JA}$	417	$^\circ\text{C}/\text{W}$
Junction and Storage Temperature	$T_J, T_{stg}$	-55 to +150	$^\circ\text{C}$

- The Power Dissipation of the package may result in a lower continuous drain current.
- Pulse Test: Pulse Width  $\leq 300 \mu\text{s}$ , Duty Cycle  $\leq 2.0\%$ .
- FR-5 =  $1.0 \times 0.75 \times 0.062$  in.
- Alumina =  $0.4 \times 0.3 \times 0.025$  in 99.5% alumina.



ON Semiconductor®

<http://onsemi.com>

$V_{(BR)DSS}$	$R_{DS(on)}$ MAX	$I_D$ MAX
60 V	$7.5 \Omega @ 10 \text{ V}, 500 \text{ mA}$	115 mA

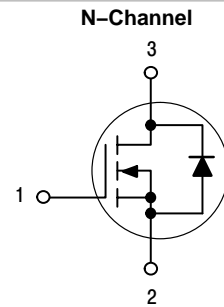

### MARKING DIAGRAM & PIN ASSIGNMENT

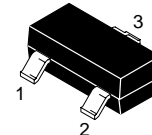

SOT-23  
CASE 318  
STYLE 21

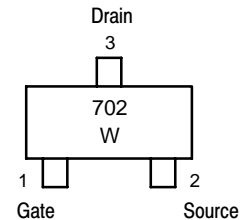

702 = Device Code  
W = Work Week

### ORDERING INFORMATION

Device	Package	Shipping†
2N7002LT1	SOT-23	3000 Tape & Reel
2N7002LT3		10,000 Tape & Reel
2N7002LT1G	SOT-23 (Pb-free)	3000 Tape & Reel
2N7002LT3G		10,000 Tape & Reel

†For information on tape and reel specifications, including part orientation and tape sizes, please refer to our Tape and Reel Packaging Specifications Brochure, BRD8011/D.

# 2N7002L

## ELECTRICAL CHARACTERISTICS (T<sub>A</sub> = 25°C unless otherwise noted)

Characteristic	Symbol	Min	Typ	Max	Unit
----------------	--------	-----	-----	-----	------

### OFF CHARACTERISTICS

Drain–Source Breakdown Voltage (V <sub>GS</sub> = 0, I <sub>D</sub> = 10 μAdc)	V <sub>(BR)DSS</sub>	60	–	–	Vdc
Zero Gate Voltage Drain Current (V <sub>GS</sub> = 0, V <sub>DS</sub> = 60 Vdc)	I <sub>DSS</sub>	–	–	1.0	μAdc
		–	–	500	
Gate–Body Leakage Current, Forward (V <sub>GS</sub> = 20 Vdc)	I <sub>GSSF</sub>	–	–	100	nAdc
Gate–Body Leakage Current, Reverse (V <sub>GS</sub> = –20 Vdc)	I <sub>GSSR</sub>	–	–	–100	nAdc

### ON CHARACTERISTICS (Note 5)

Gate Threshold Voltage (V <sub>DS</sub> = V <sub>GS</sub> , I <sub>D</sub> = 250 μAdc)	V <sub>GS(th)</sub>	1.0	–	2.5	Vdc
On–State Drain Current (V <sub>DS</sub> ≥ 2.0 V <sub>DS(on)</sub> , V <sub>GS</sub> = 10 Vdc)	I <sub>D(on)</sub>	500	–	–	mA
Static Drain–Source On–State Voltage (V <sub>GS</sub> = 10 Vdc, I <sub>D</sub> = 500 mAdc) (V <sub>GS</sub> = 5.0 Vdc, I <sub>D</sub> = 50 mAdc)	V <sub>DS(on)</sub>	–	–	3.75 0.375	Vdc
Static Drain–Source On–State Resistance (V <sub>GS</sub> = 10 V, I <sub>D</sub> = 500 mAdc)  (V <sub>GS</sub> = 5.0 Vdc, I <sub>D</sub> = 50 mAdc)	r <sub>DS(on)</sub>	–	–	7.5 13.5 7.5 13.5	Ohms
		–	–	–	
		–	–	–	
		–	–	–	
Forward Transconductance (V <sub>DS</sub> ≥ 2.0 V <sub>DS(on)</sub> , I <sub>D</sub> = 200 mAdc)	g <sub>FS</sub>	80	–	–	mmhos

### DYNAMIC CHARACTERISTICS

Input Capacitance (V <sub>DS</sub> = 25 Vdc, V <sub>GS</sub> = 0, f = 1.0 MHz)	C <sub>iss</sub>	–	–	50	pF
Output Capacitance (V <sub>DS</sub> = 25 Vdc, V <sub>GS</sub> = 0, f = 1.0 MHz)	C <sub>oss</sub>	–	–	25	pF
Reverse Transfer Capacitance (V <sub>DS</sub> = 25 Vdc, V <sub>GS</sub> = 0, f = 1.0 MHz)	C <sub>rss</sub>	–	–	5.0	pF

### SWITCHING CHARACTERISTICS (Note 5)

Turn–On Delay Time	(V <sub>DD</sub> = 25 Vdc, I <sub>D</sub> ≅ 500 mAdc, R <sub>G</sub> = 25 Ω, R <sub>L</sub> = 50 Ω, V <sub>gen</sub> = 10 V)	t <sub>d(on)</sub>	–	–	20	ns
Turn–Off Delay Time		t <sub>d(off)</sub>	–	–	40	ns

### BODY–DRAIN DIODE RATINGS

Diode Forward On–Voltage (I <sub>S</sub> = 11.5 mAdc, V <sub>GS</sub> = 0 V)	V <sub>SD</sub>	–	–	–1.5	Vdc
Source Current Continuous (Body Diode)	I <sub>S</sub>	–	–	–115	mAdc
Source Current Pulsed	I <sub>SM</sub>	–	–	–800	mAdc

5. Pulse Test: Pulse Width ≤ 300 μs, Duty Cycle ≤ 2.0%.

# 2N7002L

## TYPICAL ELECTRICAL CHARACTERISTICS

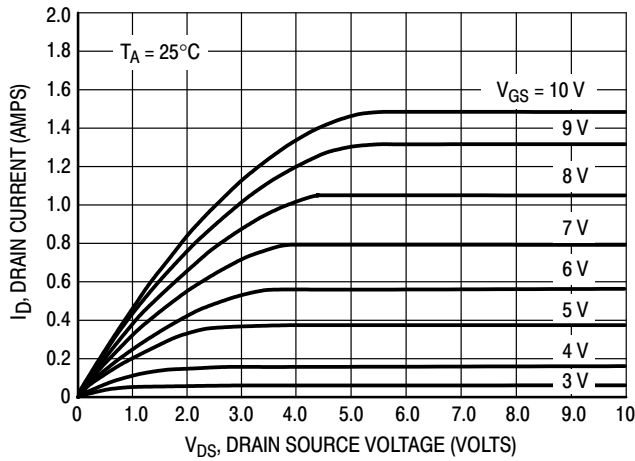

Figure 1. Ohmic Region

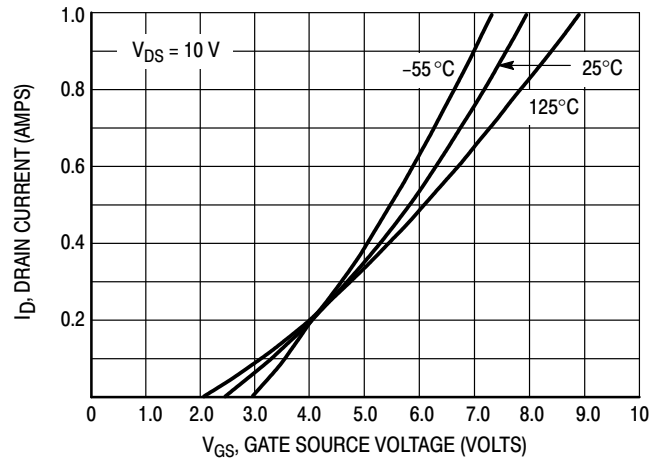

Figure 2. Transfer Characteristics

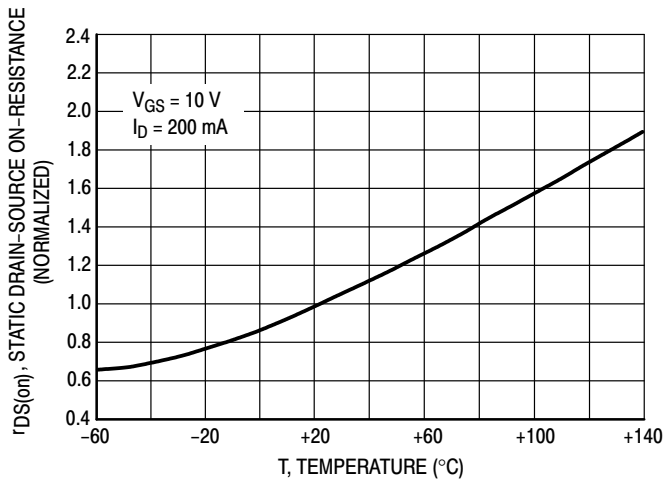

Figure 3. Temperature versus Static Drain-Source On-Resistance

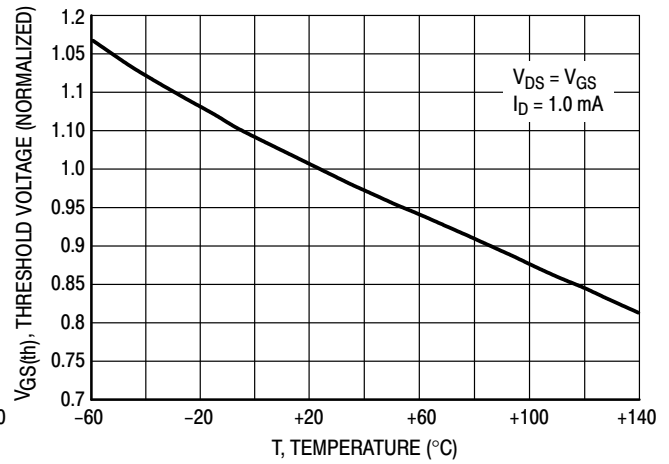

Figure 4. Temperature versus Gate Threshold Voltage

# 2N7002L

## PACKAGE DIMENSIONS

SOT-23 (TO-236)  
CASE 318-08  
ISSUE AH

- NOTES:
1. DIMENSIONING AND TOLERANCING PER ANSI Y14.5M, 1982.
  2. CONTROLLING DIMENSION: INCH.
  3. MAXIMUM LEAD THICKNESS INCLUDES LEAD FINISH THICKNESS. MINIMUM LEAD THICKNESS IS THE MINIMUM THICKNESS OF BASE MATERIAL.
  4. 318-03 AND -07 OBSOLETE, NEW STANDARD 318-08.

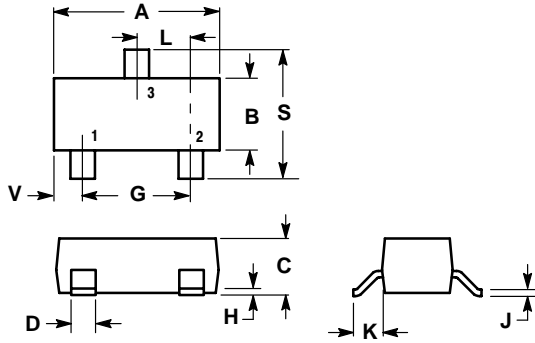

DIM	INCHES		MILLIMETERS	
	MIN	MAX	MIN	MAX
A	0.1102	0.1197	2.80	3.04
B	0.0472	0.0551	1.20	1.40
C	0.0350	0.0440	0.89	1.11
D	0.0150	0.0200	0.37	0.50
G	0.0701	0.0807	1.78	2.04
H	0.0005	0.0040	0.013	0.100
J	0.0034	0.0070	0.085	0.177
K	0.0140	0.0285	0.35	0.69
L	0.0350	0.0401	0.89	1.02
S	0.0830	0.1039	2.10	2.64
V	0.0177	0.0236	0.45	0.60

- STYLE 21:  
PIN 1. GATE  
2. SOURCE  
3. DRAIN

### SOLDERING FOOTPRINT\*

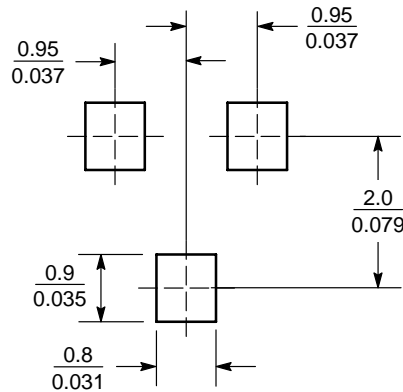

\*For additional information on our Pb-Free strategy and soldering details, please download the ON Semiconductor Soldering and Mounting Techniques Reference Manual, SOLDERRM/D.

ON Semiconductor and are registered trademarks of Semiconductor Components Industries, LLC (SCILLC). SCILLC reserves the right to make changes without further notice to any products herein. SCILLC makes no warranty, representation or guarantee regarding the suitability of its products for any particular purpose, nor does SCILLC assume any liability arising out of the application or use of any product or circuit, and specifically disclaims any and all liability, including without limitation special, consequential or incidental damages. "Typical" parameters which may be provided in SCILLC data sheets and/or specifications can and do vary in different applications and actual performance may vary over time. All operating parameters, including "Typicals" must be validated for each customer application by customer's technical experts. SCILLC does not convey any license under its patent rights nor the rights of others. SCILLC products are not designed, intended, or authorized for use as components in systems intended for surgical implant into the body, or other applications intended to support or sustain life, or for any other application in which the failure of the SCILLC product could create a situation where personal injury or death may occur. Should Buyer purchase or use SCILLC products for any such unintended or unauthorized application, Buyer shall indemnify and hold SCILLC and its officers, employees, subsidiaries, affiliates, and distributors harmless against all claims, costs, damages, and expenses, and reasonable attorney fees arising out of, directly or indirectly, any claim of personal injury or death associated with such unintended or unauthorized use, even if such claim alleges that SCILLC was negligent regarding the design or manufacture of the part. SCILLC is an Equal Opportunity/Affirmative Action Employer. This literature is subject to all applicable copyright laws and is not for resale in any manner.

### PUBLICATION ORDERING INFORMATION

**LITERATURE FULFILLMENT:**  
Literature Distribution Center for ON Semiconductor  
P.O. Box 5163, Denver, Colorado 80217 USA  
**Phone:** 303-675-2175 or 800-344-3860 Toll Free USA/Canada  
**Fax:** 303-675-2176 or 800-344-3867 Toll Free USA/Canada  
**Email:** orderlit@onsemi.com

**N. American Technical Support:** 800-282-9855 Toll Free USA/Canada

**Japan:** ON Semiconductor, Japan Customer Focus Center  
2-9-1 Kamimeguro, Meguro-ku, Tokyo, Japan 153-0051  
**Phone:** 81-3-5773-3850

**ON Semiconductor Website:** <http://onsemi.com>

**Order Literature:** <http://www.onsemi.com/litorder>

For additional information, please contact your local Sales Representative.