

Plastic-Encapsulate Transistors

TRANSISTOR (PNP)

FEATURE

- High voltage
- Large continuous collector current capability

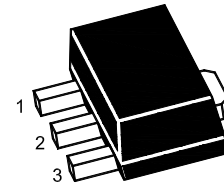

SOT-89

1.Base 2.Collector 3.Emitter
SOT-89 Plastic Package

MARKING: 1013

MAXIMUM RATINGS (T_a=25°C unless otherwise noted)

Symbol	Parameter	Value	Unit
V _{CB0}	Collector-Base Voltage	-160	V
V _{CEO}	Collector-Emitter Voltage	-160	V
V _{EBO}	Emitter-Base Voltage	-6	V
I _C	Collector Current -Continuous	-1	A
P _C	Collector Power Dissipation	0.5	W
T _j	Junction Temperature	150	°C
T _{stg}	Storage Temperature	-55~+150	°C
R _{θJA}	Thermal Resistance from Junction to Ambient	250	°C/W

ELECTRICAL CHARACTERISTICS (T_a=25°C unless otherwise specified)

Parameter	Symbol	Test conditions	Min	Max	Unit
Collector-base breakdown voltage	V _{(BR)CBO}	I _C =- 100μA , I _E =0	-160		V
Collector-emitter breakdown voltage	V _{(BR)CEO}	I _C = -1mA , I _B =0	-160		V
Emitter-base breakdown voltage	V _{(BR)EBO}	I _E = -10μA, I _C =0	-6		V
Collector cut-off current	I _{CBO}	V _{CB} =-150 V , I _E =0		-1	μA
Emitter cut-off current	I _{EBO}	V _{EB} =-6V, I _C =0		-1	μA
DC current gain	h _{FE}	V _{CE} =-5 V, I _C =- 200mA	60	320	
Collector-emitter saturation voltage	V _{CE(sat)}	I _C = -500m A, I _B = -50mA		-1.5	V
Base-emitter voltage	V _{BE}	I _C = -5 mA, V _{CE} =- 5V		-0.75	V
Transition frequency	f _T	V _{CE} =- 5 V, I _C = -200mA	15		MHz

CLASSIFICATION OF h_{FE}

Rank	R	O	Y
Range	60-120	100-200	160-320

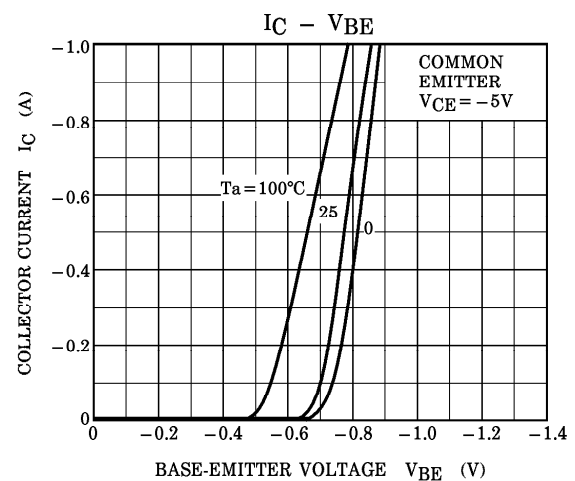
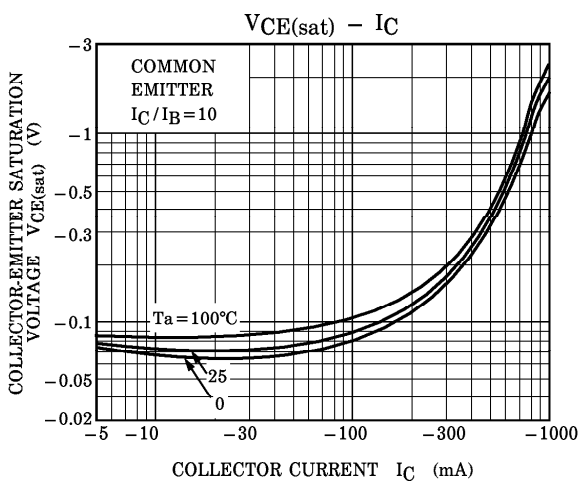
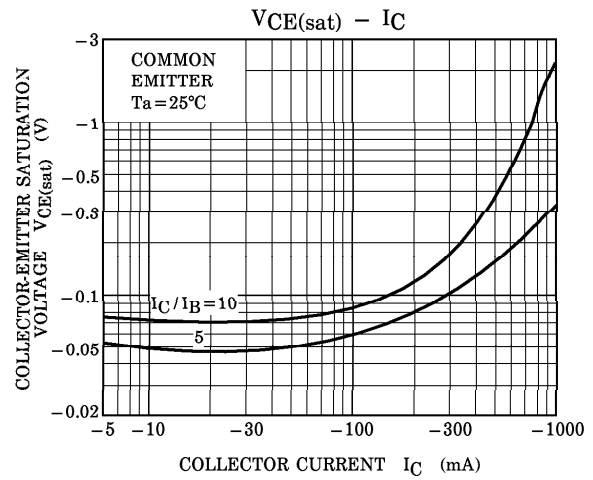
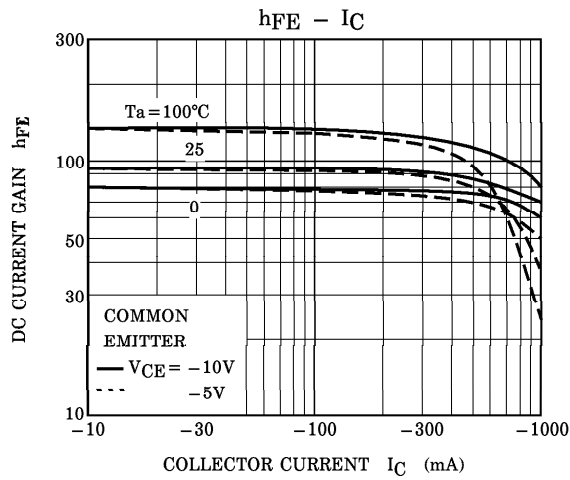
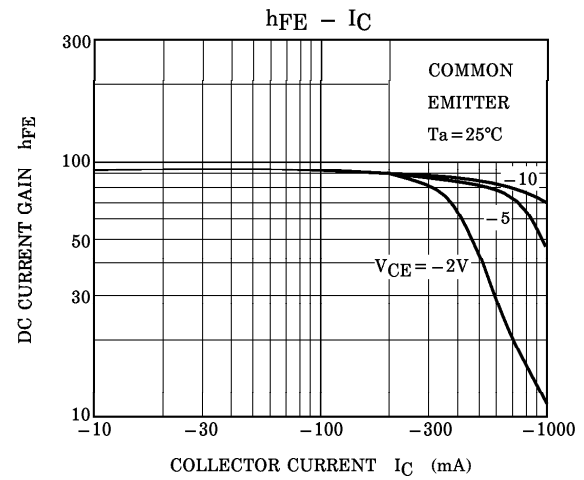
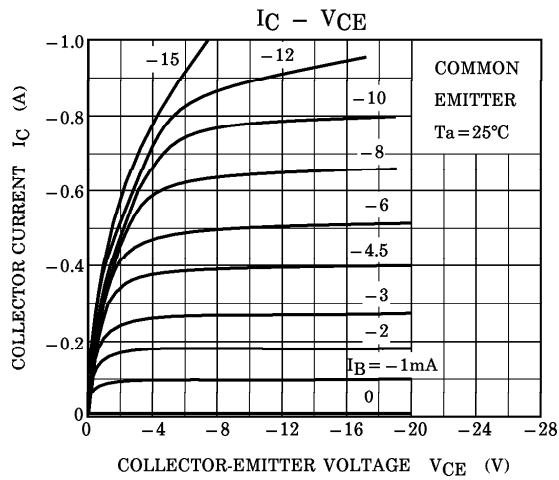

SOT-89 PACKAGE OUTLINE

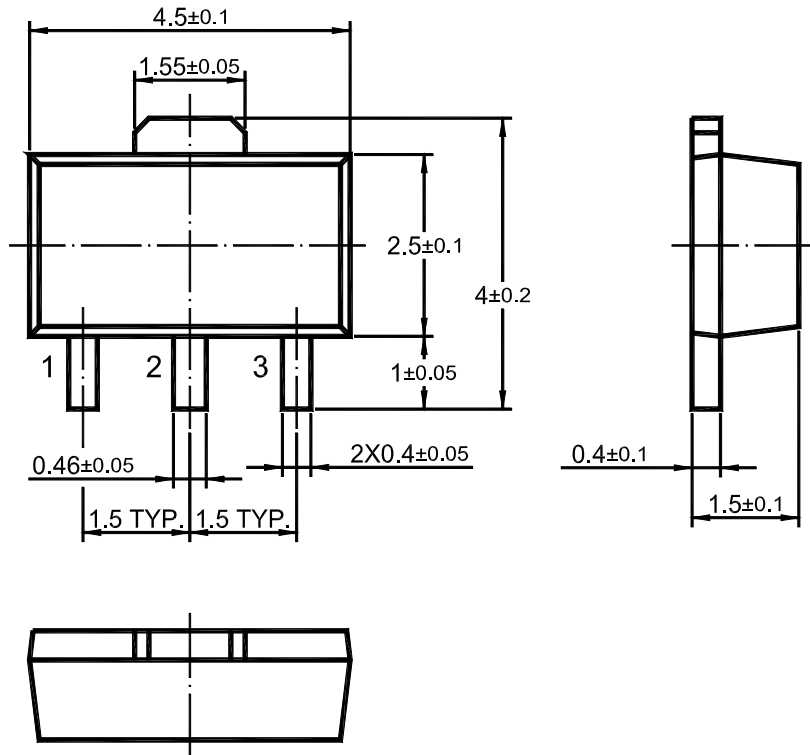

Dimensions in mm