

Silicon PNP Power Transistors

2SA1489

DESCRIPTION

- With TO-3PN package
- Complement to type 2SC3853

APPLICATIONS

- Audio and general purpose

PINNING

PIN	DESCRIPTION
1	Base
2	Collector;connected to mounting base
3	Emitter

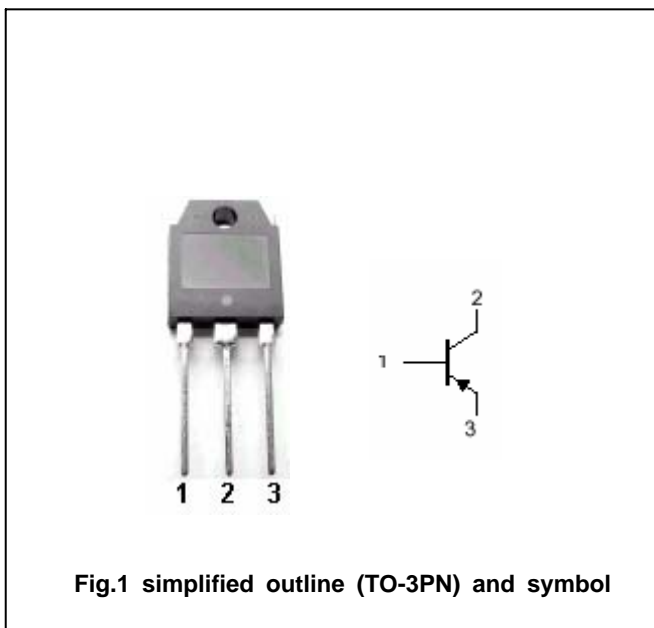

Fig.1 simplified outline (TO-3PN) and symbol

Absolute maximum ratings(Ta=)

SYMBOL	PARAMETER	CONDITIONS	VALUE	UNIT
V _{CBO}	Collector-base voltage	Open emitter	-80	V
V _{CEO}	Collector-emitter voltage	Open base	-80	V
V _{EBO}	Emitter-base voltage	Open collector	-6	V
I _C	Collector current		-6	A
I _B	Base current		-3	A
P _C	Collector power dissipation	T _C =25	60	W
T _j	Junction temperature		150	
T _{stg}	Storage temperature		-55~150	

Silicon PNP Power Transistors

2SA1489

CHARACTERISTICS

T_j=25 unless otherwise specified

SYMBOL	PARAMETER	CONDITIONS	MIN	TYP.	MAX	UNIT
V _{(BR)CEO}	Collector-emitter breakdown voltage	I _C =-50mA ; I _B =0	-80			V
V _{CEsat}	Collector-emitter saturation voltage	I _C =-2A; I _B =-0.2A			-1.5	V
I _{CBO}	Collector cut-off current	V _{CB} =-80V; I _E =0			-100	μ A
I _{EBO}	Emitter cut-off current	V _{EB} =-6V; I _C =0			-100	μ A
h _{FE}	DC current gain	I _C =-2A ; V _{CE} =-4V	50			
f _T	Transition frequency	I _C =0.5A ; V _{CE} =-12V		20		MHz

Switching times

t _{on}	Turn-on time	I _C =-3A; R _L =10 I _{B1} =-I _{B2} =-0.3A V _{CC} =30V		0.25		μ s
t _s	Storage time			0.5		μ s
t _f	Fall time			0.1		μ s

Silicon PNP Power Transistors

2SA1489

PACKAGE OUTLINE

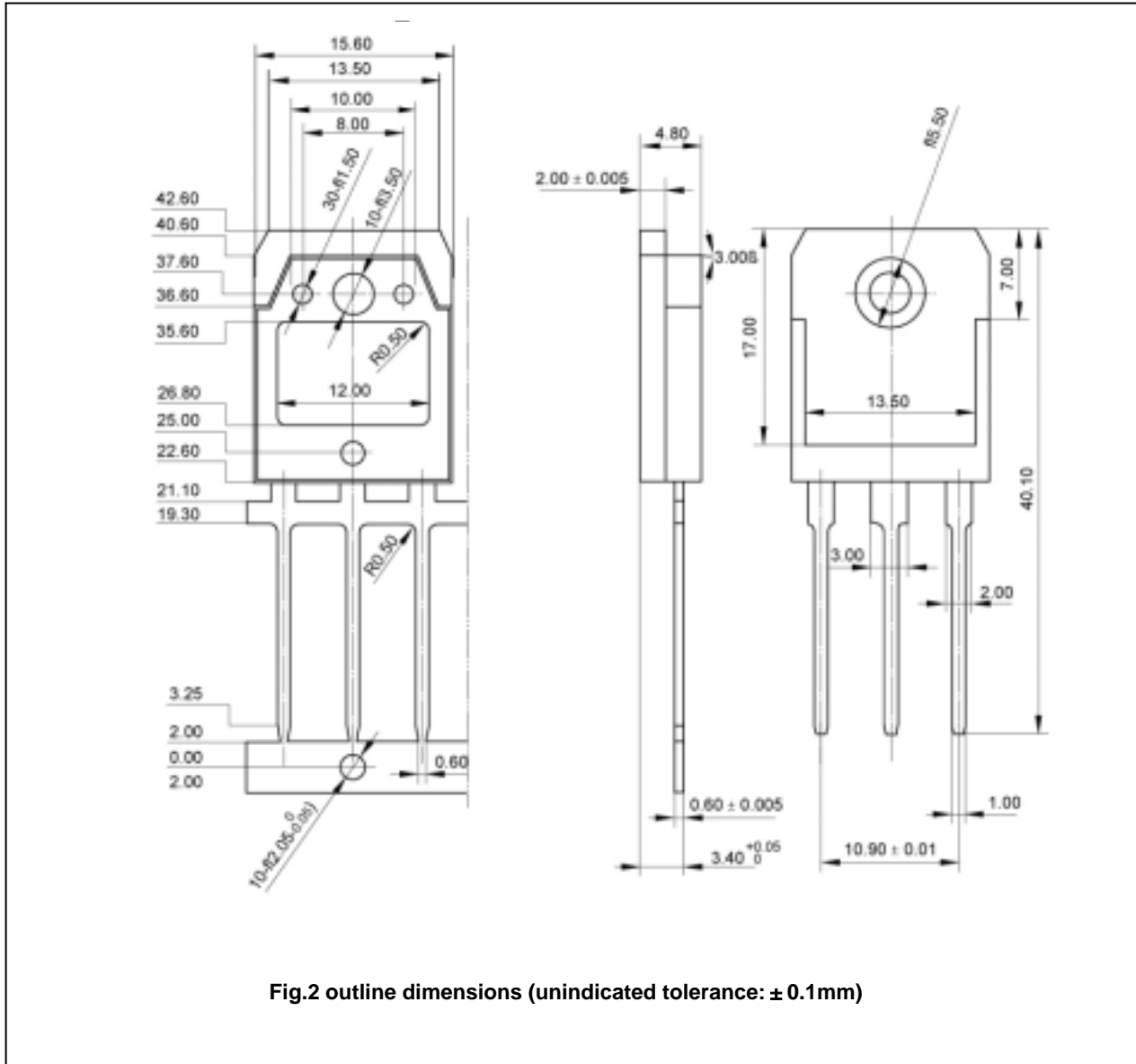

Fig.2 outline dimensions (unindicated tolerance: ± 0.1mm)