

# 2SA1734T2G

Preferred Device

## PNP Silicon Transistor

The device is housed in the SOT-89 package, which is designed for medium power surface mount applications.

- High Current: 1.2 Amp
- Available in 7 inch/1000 unit Tape and Reel
- Device Marking: SA

### MAXIMUM RATINGS (T<sub>C</sub> = 25°C unless otherwise noted)

Rating	Symbol	Value	Unit
Collector-Emitter Voltage	V <sub>CEO</sub>	-30	Vdc
Collector-Base Voltage	V <sub>CBO</sub>	-40	Vdc
Emitter-Base Voltage	V <sub>EBO</sub>	-6	Vdc
Collector Current	I <sub>C</sub>	-1.2	Adc
Total Power Dissipation @ T <sub>A</sub> = 25°C Derate above 25°C	P <sub>D</sub> (Note 1)  (Note 2)	1.56 13 0.67 5.0	Watts mW/°C Watts mW/°C
Operating and Storage Temperature Range	T <sub>J</sub> , T <sub>stg</sub>	-65 to 150	°C

### THERMAL CHARACTERISTICS

Characteristic	Symbol	Max	Unit
Thermal Resistance Junction-to-Ambient (surface mounted)	R <sub>θJA</sub> (Note 1) (Note 2)	60 190	°C/W
Maximum Temperature for Soldering Purposes Time in Solder Bath	T <sub>L</sub>	260 10	°C Sec

1. FR-4 @ 1.0 X 1.0 inch Pad 2.0 oz. Cu PCB
2. FR-4 @ Minimum Pad



ON Semiconductor®

<http://onsemi.com>

### MEDIUM POWER PNP SILICON HIGH CURRENT TRANSISTOR SURFACE MOUNT

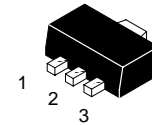
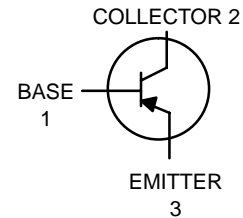

SOT-89  
CASE 1213  
STYLE 2

### MARKING DIAGRAM

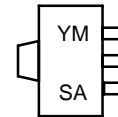

Y = Year Code  
M = Month Code  
SA = Device Code

### ORDERING INFORMATION

Device	Package	Shipping
2SA1734T2G	SOT-89	1000/Tape & Reel

Preferred devices are recommended choices for future use and best overall value.

## 2SA1734T2G

### ELECTRICAL CHARACTERISTICS ( $T_C = 25^\circ\text{C}$ unless otherwise noted)

Characteristic	Symbol	Min	Typ	Max	Unit
<b>OFF CHARACTERISTICS</b>					
Collector–Emitter Breakdown Voltage (Note 3) ( $I_C = -10\text{ mAdc}$ , $I_B = 0$ )	$V_{(BR)CEO}$	-30	–	–	Vdc
Collector Cutoff Current ( $V_{CB} = -40\text{ Vdc}$ , $I_E = 0$ )	$I_{CBO}$	–	–	-0.1	$\mu\text{Adc}$
Emitter Cutoff Current ( $V_{EB} = -6.0\text{ V}$ , $I_C = 0$ )	$I_{EBO}$	–	–	-0.1	$\mu\text{Adc}$
<b>ON CHARACTERISTICS (Note 3)</b>					
DC Current Gain ( $I_C = -100\text{ mA}$ , $V_{CE} = -2.0\text{ V}$ ) ( $I_C = -1.0\text{ A}$ , $V_{CE} = -2.0\text{ V}$ )	$h_{FE}$	120 40	– –	400 –	–
Collector–Emitter Saturation Voltage ( $I_C = -700\text{ mA}$ , $I_B = -35\text{ mA}$ )	$V_{CE(sat)}$	–	–	-0.5	Vdc
Base–Emitter Saturation Voltage ( $I_C = -700\text{ mA}$ , $I_B = -35\text{ mA}$ )	$V_{BE(sat)}$	–	–	-1.2	Vdc
<b>SMALL–SIGNAL CHARACTERISTICS</b>					
Current–Gain – Bandwidth Product (Note 4) ( $I_C = -100\text{ mAdc}$ , $V_{CE} = -2.0\text{ Vdc}$ , $f = 100\text{ MHz}$ )	$f_T$	–	100	–	MHz
Collector Output Capacitance ( $V_{CB} = -10\text{ Vdc}$ , $I_E = 0\text{ mAdc}$ , $f = 1.0\text{ MHz}$ )	$C_{OB}$	–	16	–	pF

3. Pulse Test: Pulse Width  $\leq 300\ \mu\text{s}$ , Duty Cycle = 2.0%.
4.  $f_T$  is defined as the frequency at which  $|h_{fe}|$  extrapolates to unity.

# 2SA1734T2G

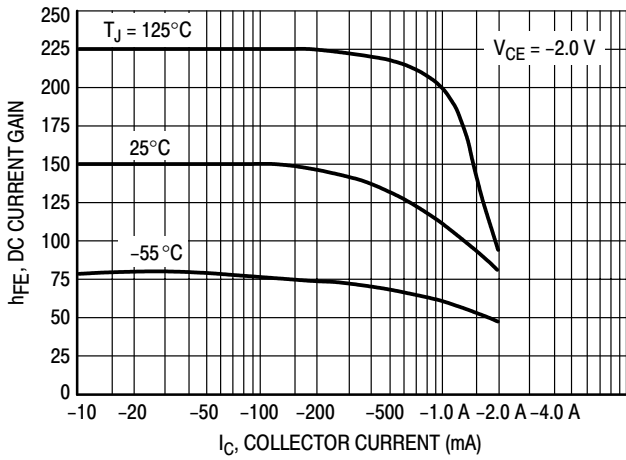

Figure 1. Typical DC Current Gain

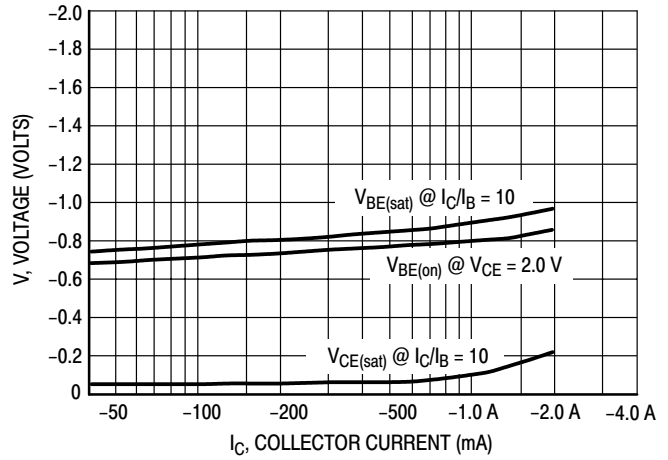

Figure 2. On Voltages

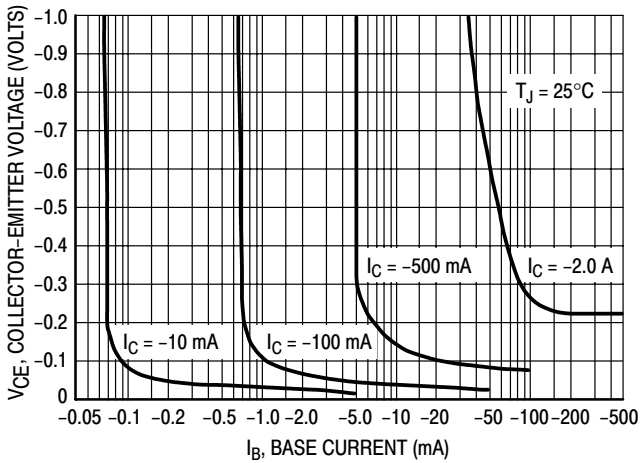

Figure 3. Collector Saturation Region

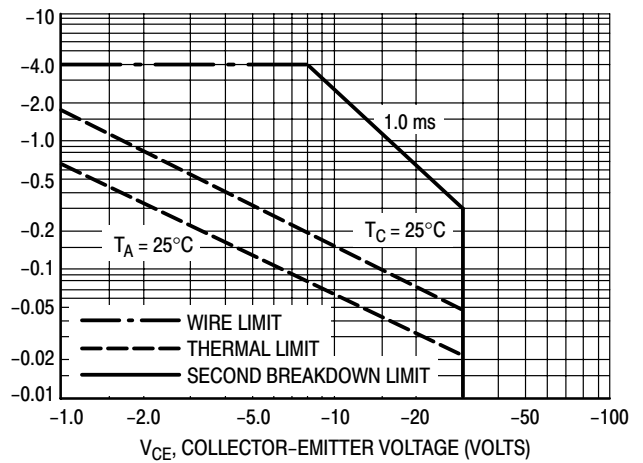
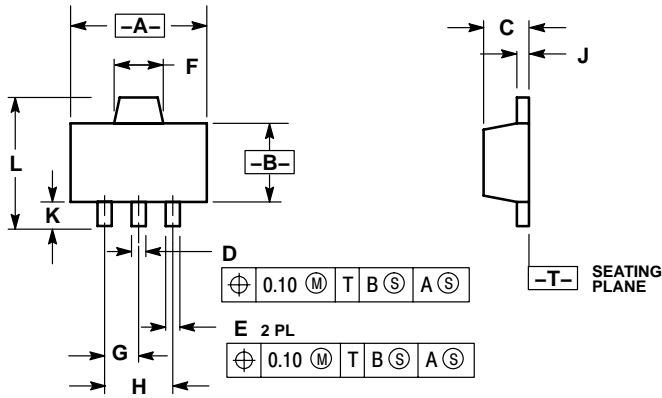

Figure 4. Safe Operating Area

# 2SA1734T2G

## PACKAGE DIMENSIONS

SOT-89  
(3-LEAD)  
CASE 1213-02  
ISSUE C



NOTES:

1. DIMENSIONING AND TOLERANCING PER ANSI Y14.5M, 1982.
2. CONTROLLING DIMENSION: MILLIMETERS
3. 1213-01 OBSOLETE, NEW STANDARD 1213-02.

DIM	MILLIMETERS		INCHES	
	MIN	MAX	MIN	MAX
A	4.40	4.60	0.173	0.181
B	2.40	2.60	0.094	0.102
C	1.40	1.60	0.055	0.063
D	0.37	0.57	0.015	0.022
E	0.32	0.52	0.013	0.020
F	1.50	1.83	0.059	0.072
G	1.50 BSC		0.059 BSC	
H	3.00 BSC		0.118 BSC	
J	0.30	0.50	0.012	0.020
K	0.80	---	0.031	---
L	---	4.25	---	0.167

STYLE 2:

- PIN 1. BASE
- COLLECTOR
- EMITTER

ON Semiconductor and  are registered trademarks of Semiconductor Components Industries, LLC (SCILLC). SCILLC reserves the right to make changes without further notice to any products herein. SCILLC makes no warranty, representation or guarantee regarding the suitability of its products for any particular purpose, nor does SCILLC assume any liability arising out of the application or use of any product or circuit, and specifically disclaims any and all liability, including without limitation special, consequential or incidental damages. "Typical" parameters which may be provided in SCILLC data sheets and/or specifications can and do vary in different applications and actual performance may vary over time. All operating parameters, including "Typicals" must be validated for each customer application by customer's technical experts. SCILLC does not convey any license under its patent rights nor the rights of others. SCILLC products are not designed, intended, or authorized for use as components in systems intended for surgical implant into the body, or other applications intended to support or sustain life, or for any other application in which the failure of the SCILLC product could create a situation where personal injury or death may occur. Should Buyer purchase or use SCILLC products for any such unintended or unauthorized application, Buyer shall indemnify and hold SCILLC and its officers, employees, subsidiaries, affiliates, and distributors harmless against all claims, costs, damages, and expenses, and reasonable attorney fees arising out of, directly or indirectly, any claim of personal injury or death associated with such unintended or unauthorized use, even if such claim alleges that SCILLC was negligent regarding the design or manufacture of the part. SCILLC is an Equal Opportunity/Affirmative Action Employer.

### PUBLICATION ORDERING INFORMATION

**Literature Fulfillment:**

Literature Distribution Center for ON Semiconductor  
P.O. Box 5163, Denver, Colorado 80217 USA  
Phone: 303-675-2175 or 800-344-3860 Toll Free USA/Canada  
Fax: 303-675-2176 or 800-344-3867 Toll Free USA/Canada  
Email: ONlit@hibbertco.com

**N. American Technical Support:** 800-282-9855 Toll Free USA/Canada

**JAPAN:** ON Semiconductor, Japan Customer Focus Center  
2-9-1 Kamimeguro, Meguro-ku, Tokyo, Japan 153-0051  
Phone: 81-3-5773-3850

**ON Semiconductor Website:** <http://onsemi.com>

For additional information, please contact your local Sales Representative.

This datasheet has been download from:

[www.datasheetcatalog.com](http://www.datasheetcatalog.com)

Datasheets for electronics components.