

Silicon PNP Power Transistors

2SA754

DESCRIPTION

- With TO-220 package
- Low collector saturation voltage

APPLICATIONS

- Inverters;converters
- Power amplification
- Switching regulator ,driver

PINNING

PIN	DESCRIPTION
1	Emitter
2	Collector;connected to mounting base
3	Base

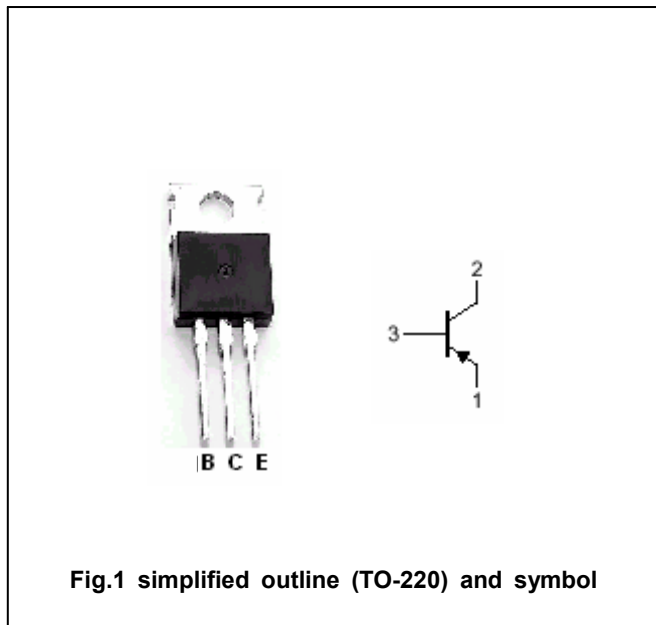

Absolute maximum ratings(Ta=25°C)

SYMBOL	PARAMETER	CONDITIONS	VALUE	UNIT
V _{CBO}	Collector-base voltage	Open emitter	-50	V
V _{CEO}	Collector-emitter voltage	Open base	-50	V
V _{EBO}	Emitter-base voltage	Open collector	-5	V
I _C	Collector current		-2	A
P _C	Collector power dissipation	T _C =25°C	20	W
T _j	Junction temperature		150	°C
T _{stg}	Storage temperature		-55~150	°C

Silicon PNP Power Transistors

2SA754

CHARACTERISTICS

T_j=25 °C unless otherwise specified

SYMBOL	PARAMETER	CONDITIONS	MIN	TYP.	MAX	UNIT
V _{(BR)CEO}	Collector-emitter breakdown voltage	I _C =-25mA, I _B =0	-50			V
V _{(BR)CBO}	Collector-base breakdown voltage	I _C =-1mA; I _E =0	-50			V
V _{(BR)EBO}	Emitter-base breakdown voltage	I _E =-1mA; I _C =0	-5			V
V _{CEsat}	Collector-emitter saturation voltage	I _C =-1A; I _B =-0.1A			-1.0	V
I _{CBO}	Collector cut-off current	V _{CB} =-50V; I _E =0			-100	μA
I _{EBO}	Emitter cut-off current	V _{EB} =-5V; I _C =0			-100	μA
h _{FE}	DC current gain	I _C =-1A; V _{CE} =-4V	35		320	
f _T	Transition frequency	I _C =-0.5A; V _{CE} =-10V		50		MHz

Silicon PNP Power Transistors

2SA754

PACKAGE OUTLINE



Fig.2 Outline dimensions(unindicated tolerance: ± 0.10 mm)