



TO-92MOD Plastic-Encapsulate Transistors

2SA817A TRANSISTOR (PNP)

TO-92MOD

- 1. EMITTER
- 2. COLLECTOR
- 3. BASE

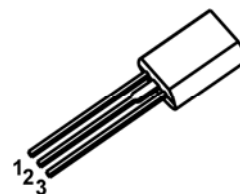

FEATURES

- . Complementary to 2SC1627A.
- . Driver Stage Application of 30 to 35 Watts Amplifiers.

MAXIMUM RATINGS (T_a=25°C unless otherwise noted)

Symbol	Parameter	Value	Unit
V _{CBO}	Collector-Base Voltage	-80	V
V _{CEO}	Collector-Emitter Voltage	-80	V
V _{EBO}	Emitter-Base Voltage	-5	V
I _C	Collector Current -Continuous	-400	mA
P _C	Collector Power Dissipation	800	mW
T _J	Junction Temperature	150	°C
T _{stg}	Storage Temperature	-55-150	°C

ELECTRICAL CHARACTERISTICS (T_a=25°C unless otherwise specified)

Parameter	Symbol	Test conditions	Min	Typ	Max	Unit
Collector-base breakdown voltage	V _{(BR)CBO}	I _C = -100 μA, I _E =0	-80			V
Collector-emitter breakdown voltage	V _{(BR)CEO}	I _C = -5 mA, I _B =0	-80			V
Emitter-base breakdown voltage	V _{(BR)EBO}	I _E = -100 μA, I _C =0	-5			V
Collector cut-off current	I _{CBO}	V _{CB} = -50 V, I _E =0			-0.1	μA
Collector cut-off current	I _{EBO}	V _{EB} = -5V, I _B =0			-0.1	μA
DC current gain	h _{FE(1)}	V _{CE} = -2V, I _C = -50mA	70		240	
	h _{FE(2)}	V _{CE} = -2V, I _C = -200mA	40			
Collector-emitter saturation voltage	V _{CE(sat)}	I _C =-200 mA, I _B = -20mA			-0.4	V
Base-emitter voltage	V _{BE}	V _{CE} = -2V, I _C = -5mA	-0.55		-0.8	V
Transition frequency	f _T	V _{CE} =-10V, I _C =-10mA		100		MHz
Out capacitance	C _{ob}	V _{CB} = -10 V, f=1MHz		14		pF

CLASSIFICATION OF h_{FE(1)}

Rank	O	Y
Range	70-140	120 - 240

Typical Characteristics

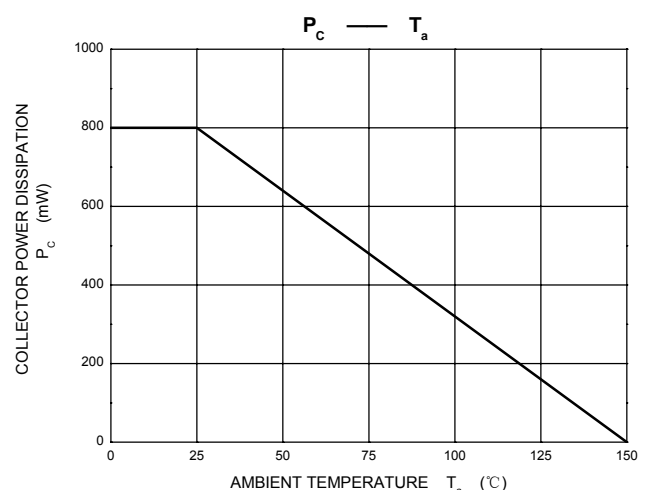
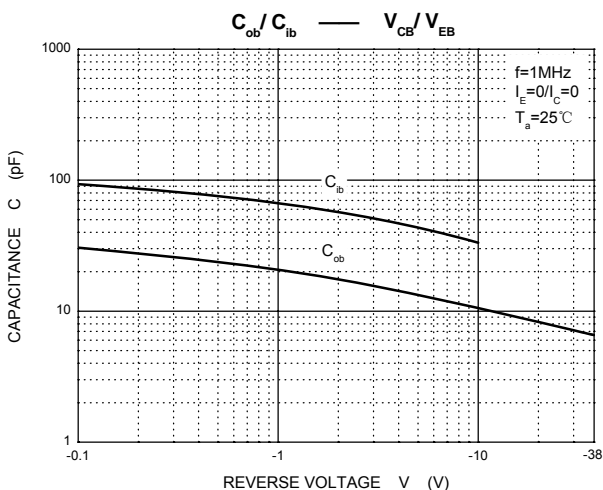
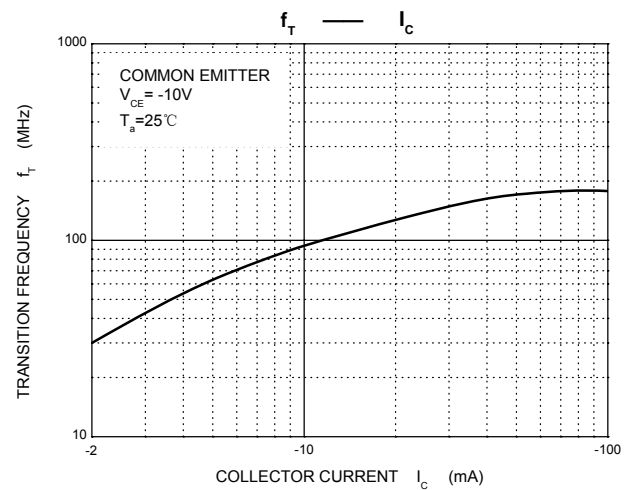
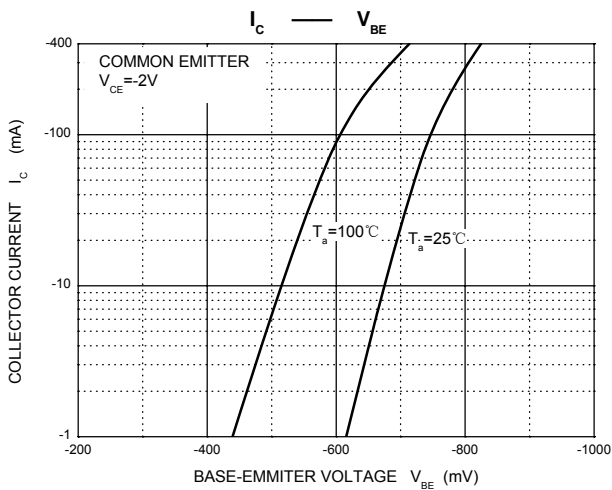
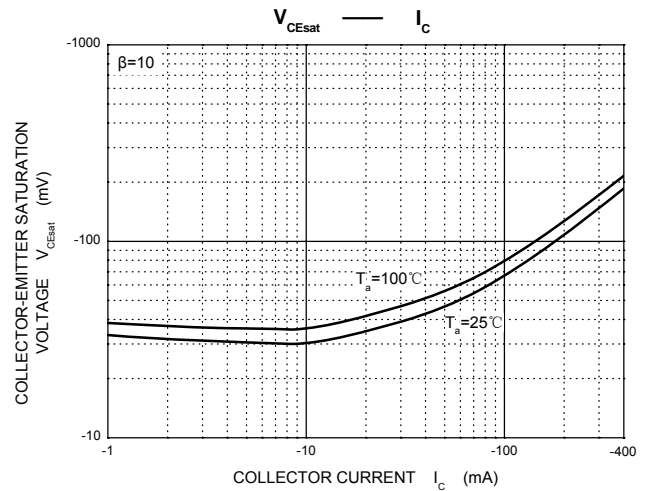
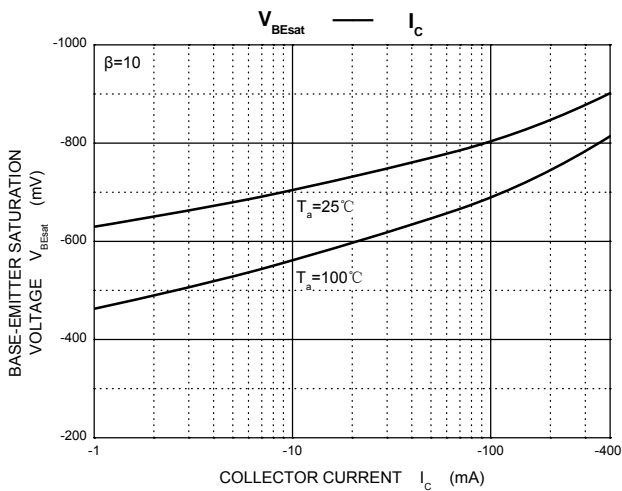
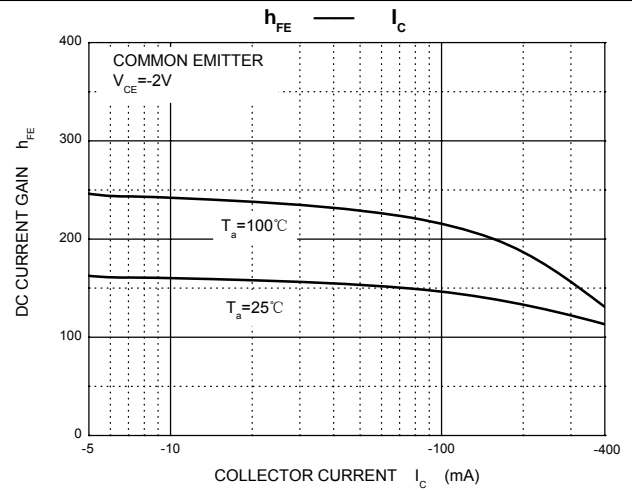
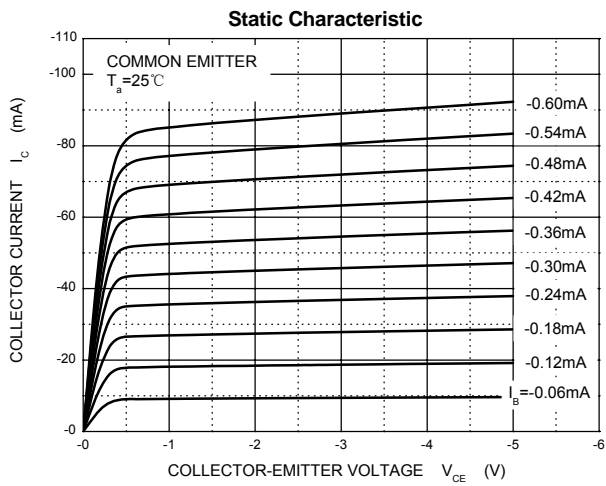

TO-92MOD Package Outline Dimensions

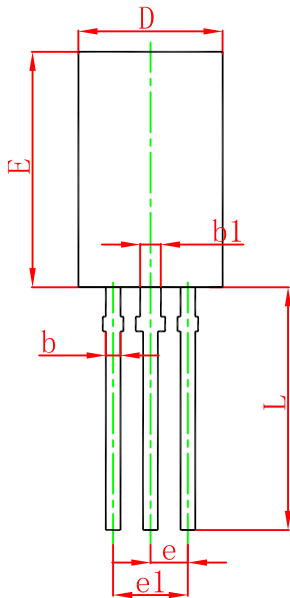
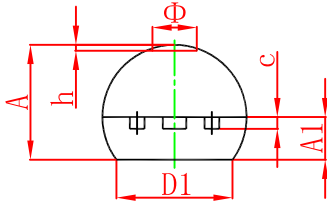

Symbol	Dimensions In Millimeters		Dimensions In Inches	
	Min.	Max.	Min.	Max.
A	4.800	5.000	0.189	0.197
A1	1.730	2.030	0.068	0.080
b	0.440	0.600	0.017	0.024
b1	0.940	1.100	0.037	0.043
c	0.350	0.450	0.014	0.018
D	5.900	6.100	0.232	0.240
D1	4.000		0.157	
E	8.500	8.700	0.335	0.343
e	1.500 TYP.		0.059 TYP.	
e1	2.900	3.100	0.114	0.122
L	13.800	14.200	0.543	0.559
Φ		1.600		0.063
h	0.000	0.380	0.000	0.015

TO-92MOD Suggested Pad Layout

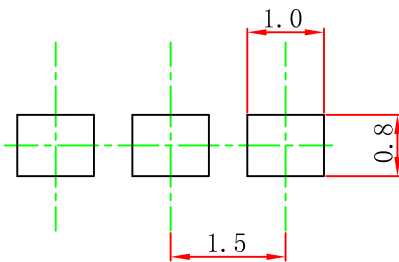

Note:

1. Controlling dimension: in millimeters.
2. General tolerance: ± 0.05 mm.
3. The pad layout is for reference purposes only.

NOTICE

JCET reserve the right to make modifications, enhancements, improvements, corrections or other changes without further notice to any product herein. JCET does not assume any liability arising out of the application or use of any product described herein.

TO-92MOD PACKAGE TAPEING DIMENSION

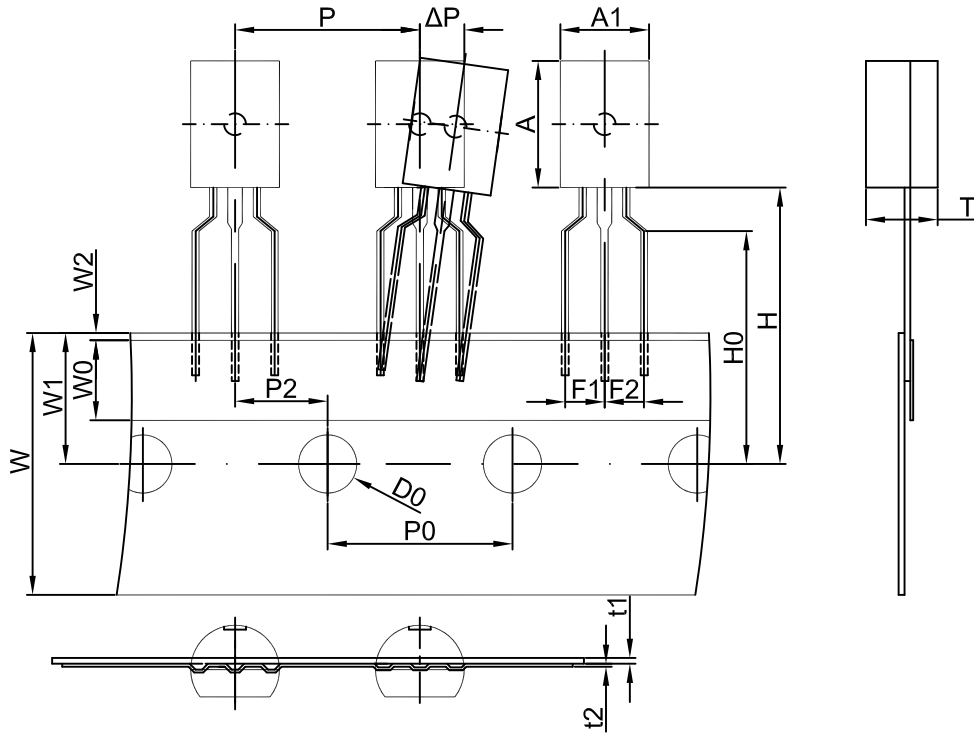

Dimensions are in millimeter

A1	A	T	P	P0	P2	F1	F2	W
6.0	8.6	4.9	12.7	12.7	6.35	2.5	2.5	18.0
W0	W1	W2	H	H0	D0	t1	t2	ΔP
6.0	9.0	1.0	19.0	16.0	4.0	0.4	0.2	0

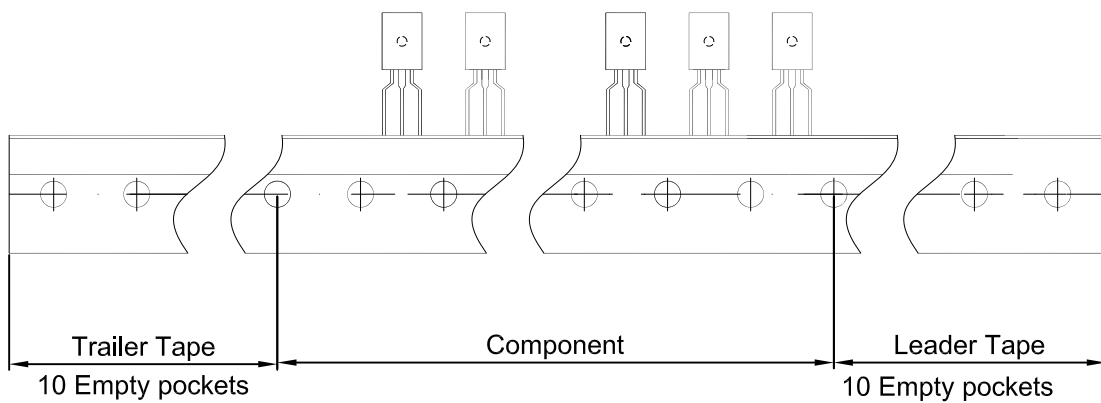

Package	Box	Box Size(mm)	Carton	Carton Size(mm)
TO-92MOD	2000 pcs	333×245×43	20,000 pcs	573×404×266