

Silicon PNP Power Transistors

2SA885

DESCRIPTION

- With TO-126 package
- Complement to type 2SC1846
- Low collector-emitter saturation voltage

APPLICATIONS

- For low-frequency power amplification

PINNING

PIN	DESCRIPTION
1	Emitter
2	Collector;connected to mounting base
3	Base

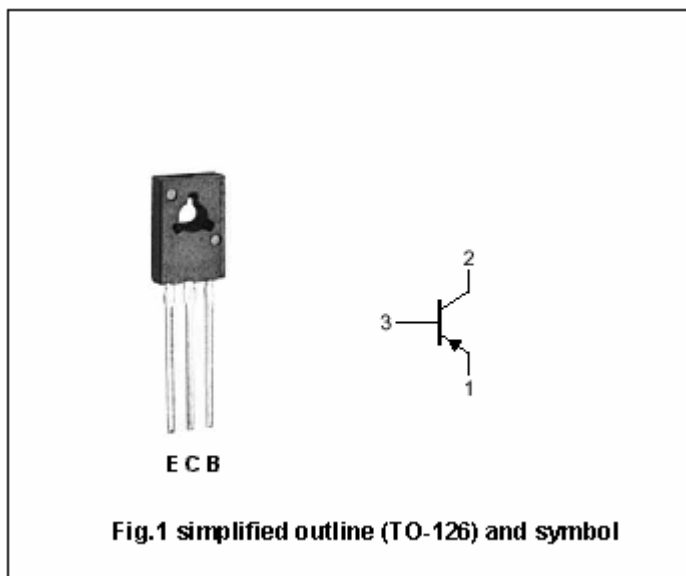

Absolute Maximum Ratings (Ta=25℃)

SYMBOL	PARAMETER	CONDITIONS	VALUE	UNIT
V _{CBO}	Collector-base voltage	Open emitter	-45	V
V _{CEO}	Collector-emitter voltage	Open base	-35	V
V _{EBO}	Emitter-base voltage	Open collector	-5	V
I _C	Collector current (DC)		-1	A
I _{CM}	Collector current-peak		-1.5	A
P _C	Collector power dissipation	T _C =25℃	1.2 ^{*1}	W
			5 ^{*2}	
T _j	Junction temperature		150	℃
T _{stg}	Storage temperature		-55~150	℃

Note) *1: Without heat sink

*2: With a 100 × 100 × 2 mm A1 heat sink

Silicon PNP Power Transistors

2SA885

CHARACTERISTICS

T_j=25 °C unless otherwise specified

SYMBOL	PARAMETER	CONDITIONS	MIN	TYP.	MAX	UNIT
V _{(BR)CEO}	Collector-emitter breakdown voltage	I _C =-2mA; I _B =0	-35			V
V _{(BR)CBO}	Collector-base breakdown voltage	I _C =-10μA ; I _E =0	-45			V
V _{CEsat}	Collector-emitter saturation voltage	I _C =-0.5A ; I _B =-50mA			-0.5	V
I _{CBO}	Collector cut-off current	V _{CB} =-20V; I _E =0			-0.1	μA
I _{CEO}	Collector cut-off current	V _{CE} =-20V; I _B =0			-100	μA
I _{EBO}	Emitter cut-off current	V _{EB} =-5V; I _C =0			-10	μA
h _{FE-1}	DC current gain	I _C =-0.5A ; V _{CE} =-10V	85		340	
h _{FE-2}	DC current gain	I _C =-1A ; V _{CE} =-5V	50			
C _{OB}	Output capacitance	I _E =0 ; V _{CB} =-10V; f=1MHz		20	30	pF
f _T	Transition frequency	I _C =50mA ; V _{CB} =-10V; f=200MHz		200		MHz

◆ h_{FE-1} Classifications

Q	R	S
85-170	120-240	170-340

Silicon PNP Power Transistors

2SA885

PACKAGE OUTLINE

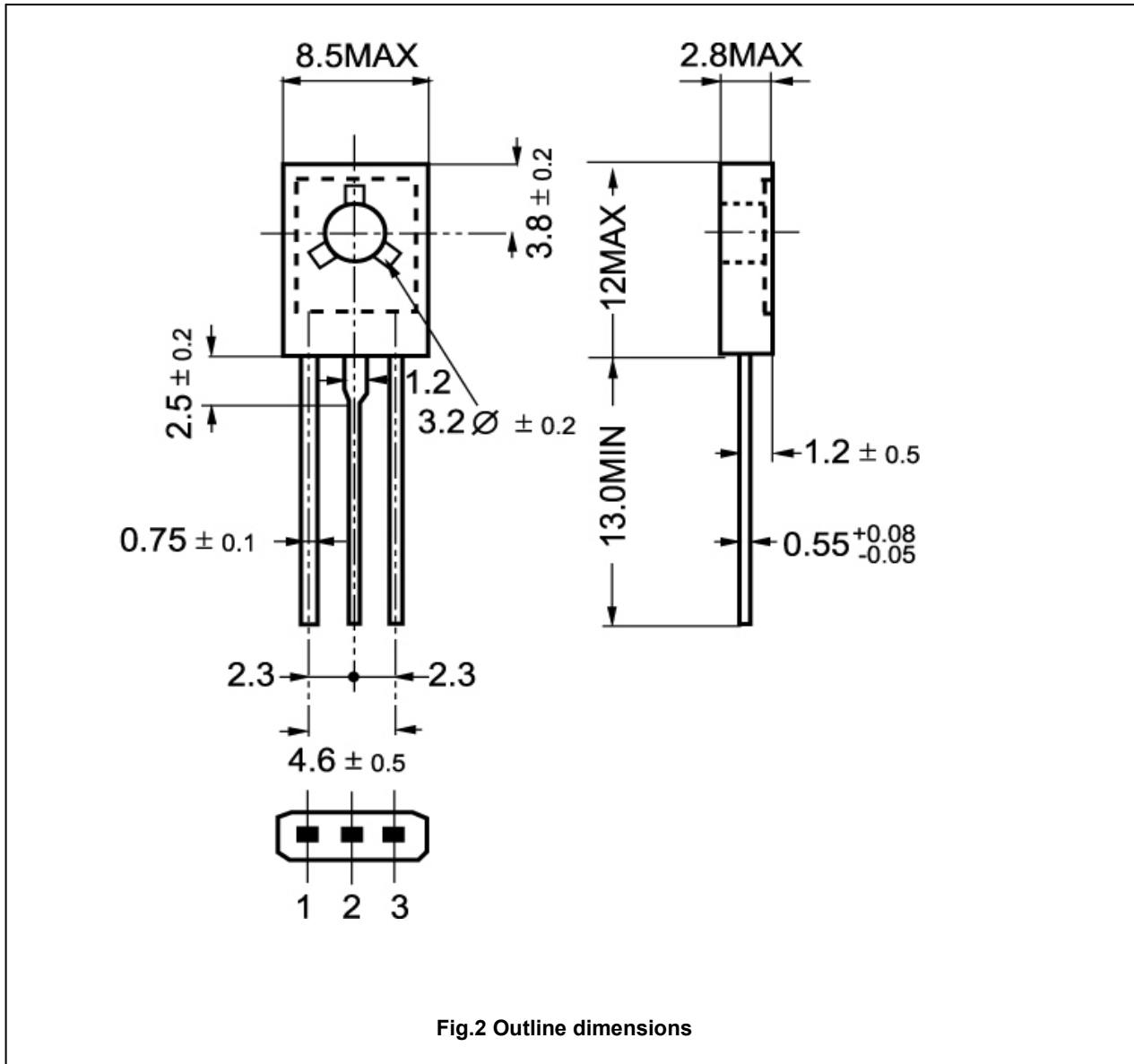

Silicon PNP Power Transistors

2SA885

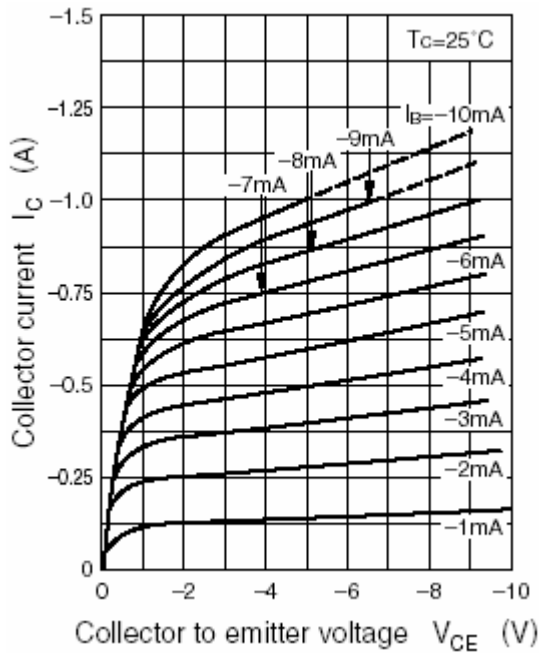

Fig.3 Static Characteristic

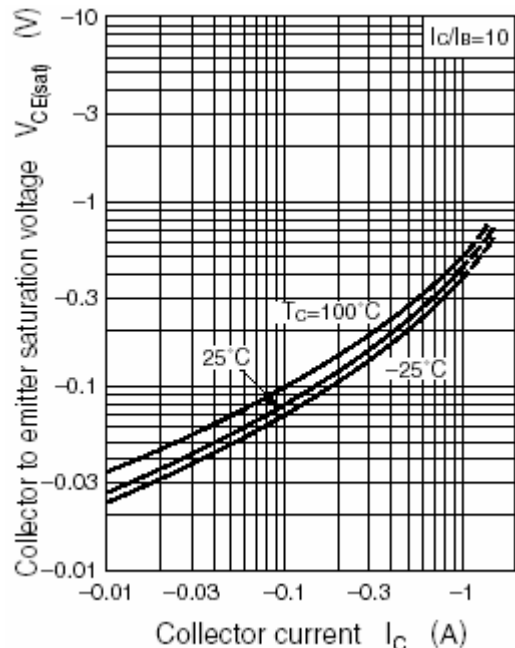

Fig.4 Collector-Emitter Saturation Voltage

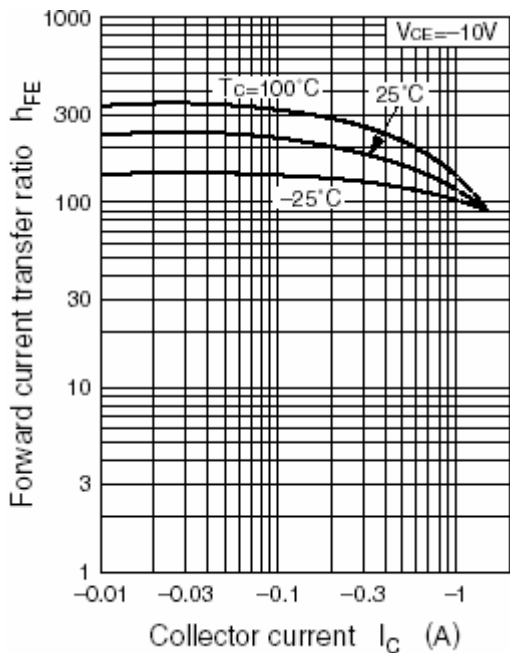

Fig.5 DC current Gain

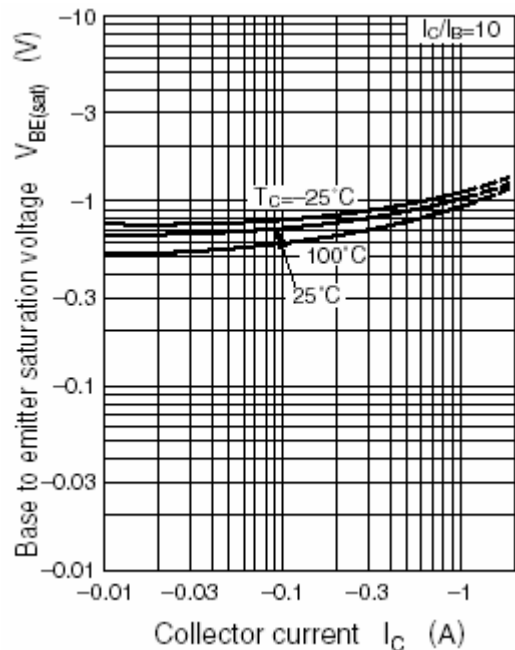

Fig.6 Base-Emitter Saturation Voltage

Silicon PNP Power Transistors

2SA885

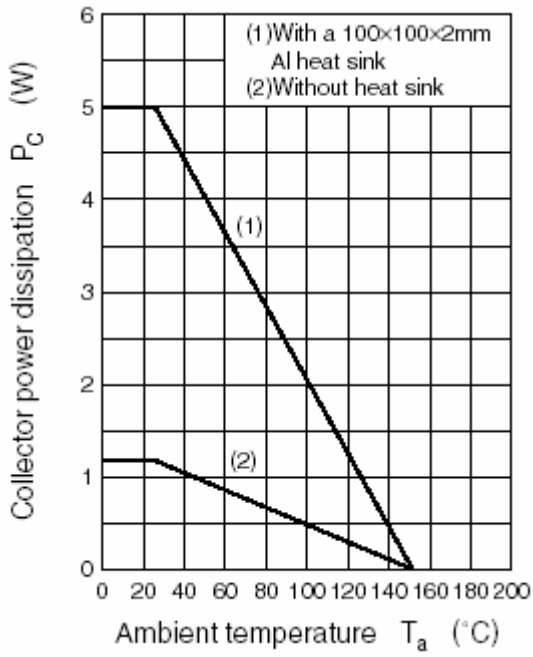

Fig.7 Power Derating

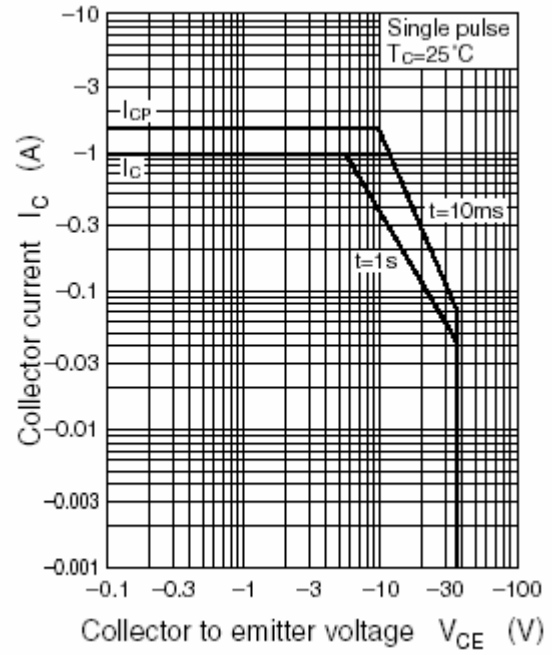

Fig.8 Safe Operating Area