

Silicon PNP Power Transistors

2SB1018A

DESCRIPTION

- With TO-220F package
- High collector current
- Low collector saturation voltage
- Complement to type 2SD1411A

APPLICATIONS

- Power amplifier applications
- High current switching applications

PINNING

PIN	DESCRIPTION
1	Emitter
2	Collector
3	Base

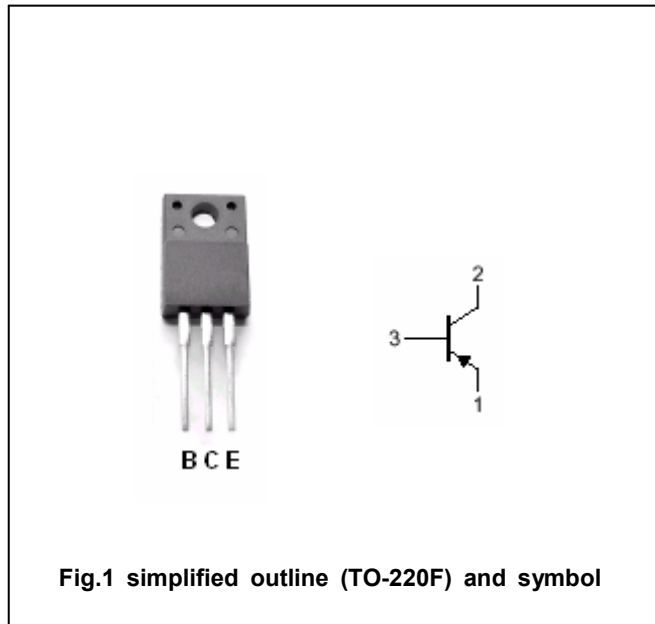

Absolute maximum ratings(Ta=25°C)

SYMBOL	PARAMETER	CONDITIONS	VALUE	UNIT
V _{CBO}	Collector-base voltage	Open emitter	-100	V
V _{CEO}	Collector -emitter voltage	Open base	-80	V
V _{EBO}	Emitter-base voltage	Open collector	-5	V
I _C	Collector current		-7	A
I _B	Base current		-1	A
P _C	Collector power dissipation	T _C =25°C	30	W
		T _a =25°C	2	
T _j	Junction temperature		150	°C
T _{stg}	Storage temperature		-55~150	°C

Silicon PNP Power Transistors

2SB1018A

CHARACTERISTICS

T_j=25°C unless otherwise specified

SYMBOL	PARAMETER	CONDITIONS	MIN	TYP.	MAX	UNIT
V _{(BR)CEO}	Collector-emitter breakdown voltage	I _C =-50mA; I _B =0	-80			V
V _{CEsat}	Collector-emitter saturation voltage	I _C =-4A ; I _B =-0.4A		-0.3	-0.5	V
V _{BEsat}	Base-emitter saturation voltage	I _C =-4A ; I _B =-0.4A		-0.9	-1.4	V
I _{CBO}	Collector cut-off current	V _{CB} =-100V; I _E =0			-5	μA
I _{EBO}	Emitter cut-off current	V _{EB} =-5V; I _C =0			-5	μA
h _{FE-1}	DC current gain	I _C =-1A ; V _{CE} =-1V	70		240	
h _{FE-2}	DC current gain	I _C =-4A ; V _{CE} =-1V	30			
f _T	Transition frequency	V _{CE} =-4V; I _C =-1A		10		MHz
C _{OB}	Collector output capacitance	f=1MHz ; V _{CB} =-10V; I _E =0		250		pF

Switching times

t _{on}	Turn-on time	I _{B1} =-I _{B2} =-0.3A V _{CC} =30V , R _L =10Ω		0.4		μs
t _{stg}	Storage time			2.5		μs
t _f	Fall time			0.5		μs

◆ h_{FE-1} Classifications

O	Y
70-140	120-240

Silicon PNP Power Transistors

2SB1018A

PACKAGE OUTLINE

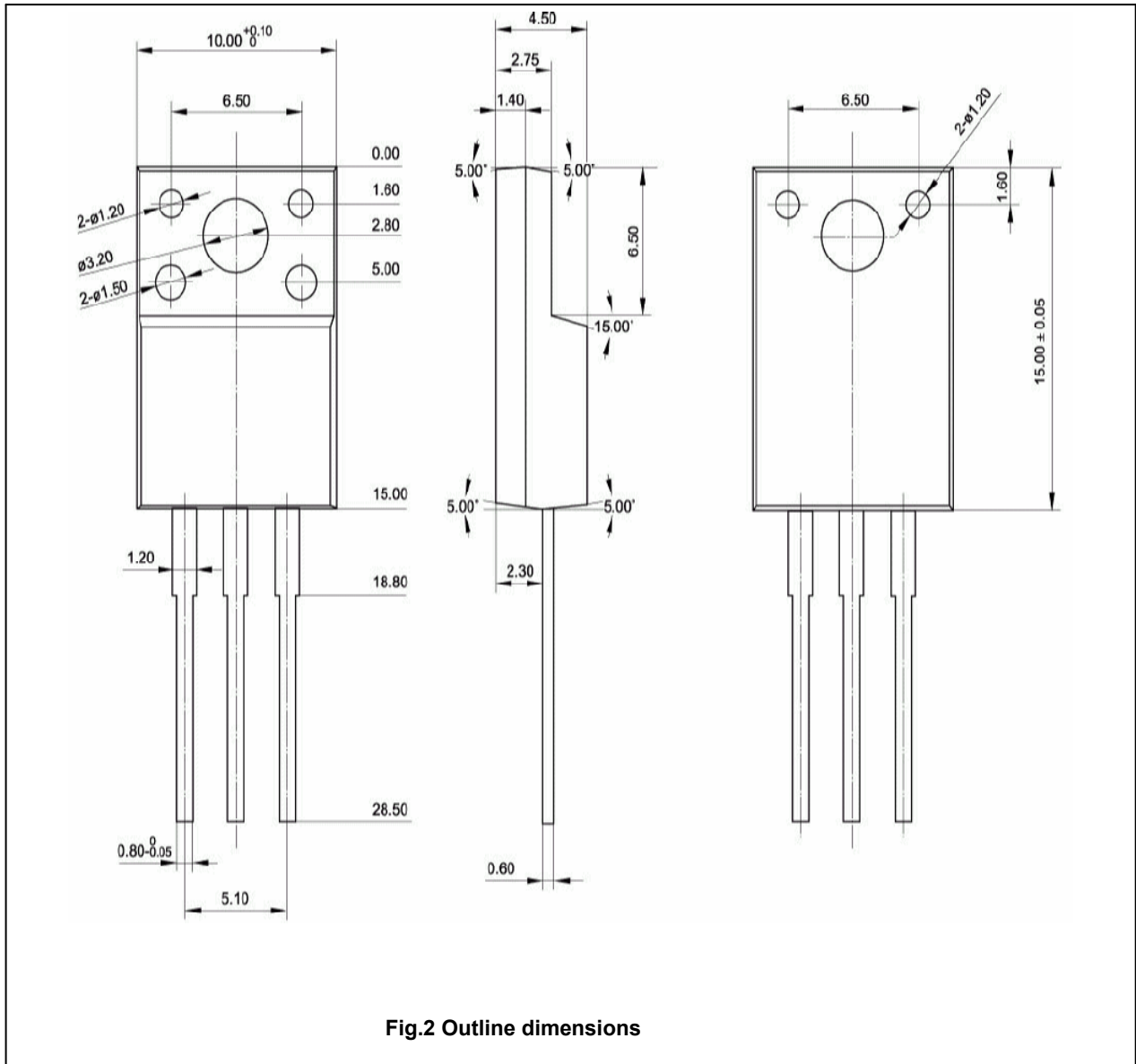

Fig.2 Outline dimensions

Silicon PNP Power Transistors

2SB1018A

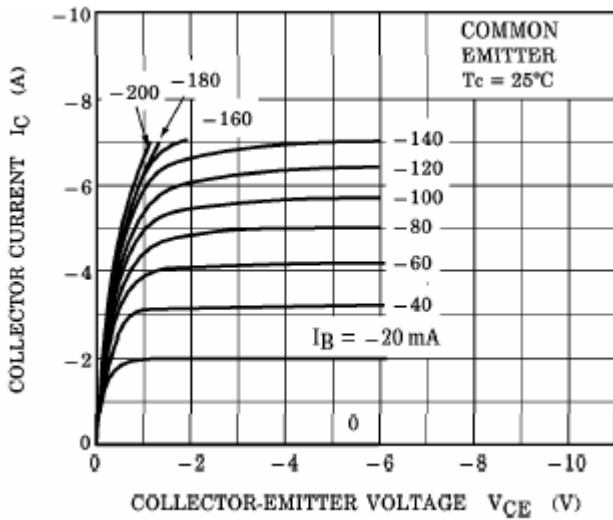

Fig.3 Static Characteristic

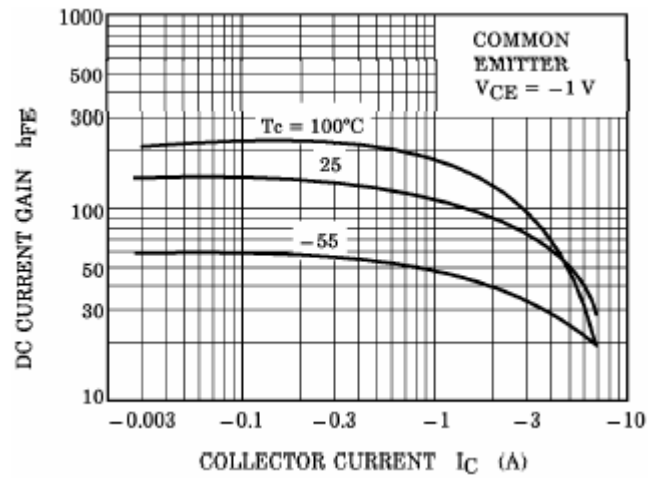

Fig.4 DC current Gain

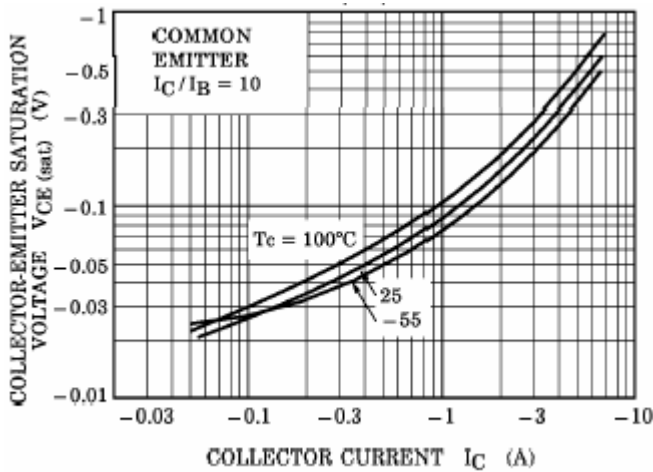

Fig.5 Collector-Emitter Saturation Voltage

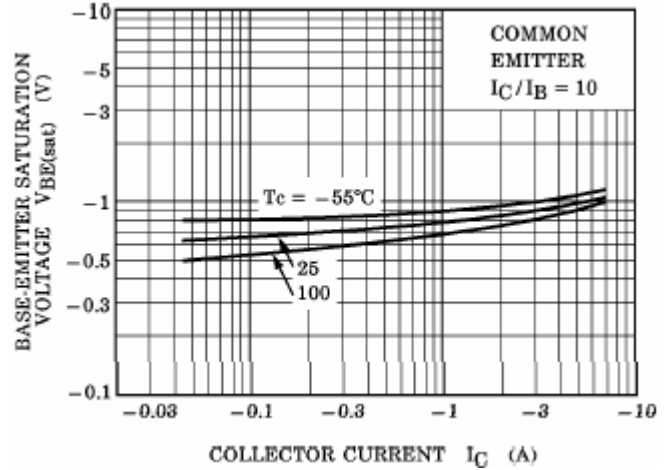

Fig.6 Base-Emitter Saturation Voltage

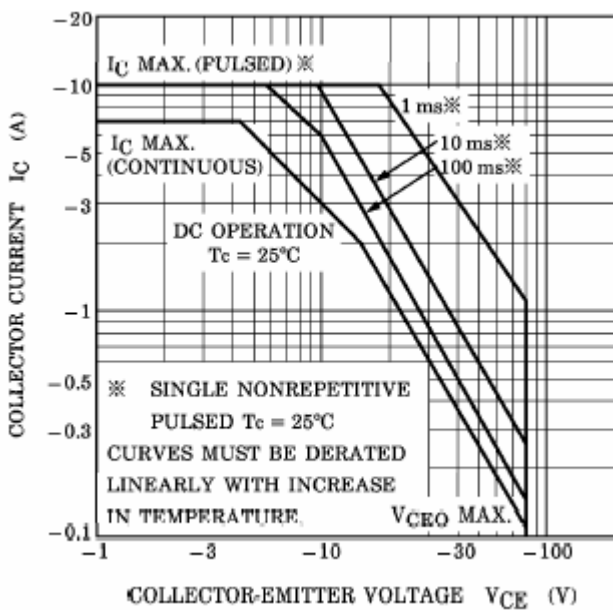

Fig.7 Safe Operating Area