

Low $V_{CE(sat)}$ Transistor(-20V,-3A)

2SB1424

FEATURES

- Low $V_{CE(SAT)}=-0.2V$ (Typ.)
($I_C/I_B=-2A/-0.1mA$).
- Excellent DC current gain characteristics.
- Complementary the 2SD2150.

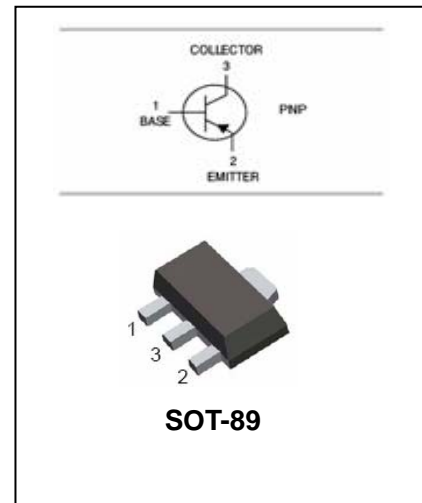

APPLICATIONS

- This device is designed as a general purpose amplifier and switching.

ORDERING INFORMATION

Type No.	Marking	Package Code
2SB1424	AEQ/AER	SOT-89

MAXIMUM RATING @ $T_a=25^{\circ}C$ unless otherwise specified

Symbol	Parameter	Value	Unit
V_{CBO}	Collector-Base Voltage	-20	V
V_{CEO}	Collector-Emitter Voltage	-20	V
V_{EBO}	Emitter-Base Voltage	-6	V
I_C	Collector Current -DC -Pulse	-3 -5	A
P_C	Collector power Dissipation	0.5	W
T_j, T_{stg}	Junction and Storage Temperature	-55 to +150	$^{\circ}C$

Low $V_{CE(sat)}$ Transistor(-20V,-3A)

2SB1424

ELECTRICAL CHARACTERISTICS @ $T_a=25^\circ\text{C}$ unless otherwise specified

Parameter	Symbol	Test conditions	MIN	TYP	MAX	UNIT
Collector-base breakdown voltage	$V_{(BR)CBO}$	$I_C=-50\mu\text{A } I_E=0$	-20			V
Collector-emitter breakdown voltage	$V_{(BR)CEO}$	$I_C=-1\text{mA } I_B=0$	-20			V
Emitter-base breakdown voltage	$V_{(BR)EBO}$	$I_E=-50\mu\text{A } I_C=0$	-6			V
Collector cut-off current	I_{CBO}	$V_{CB}=-20\text{V } I_E=0$			-0.1	μA
Emitter cut-off current	I_{EBO}	$V_{EB}=-5\text{V}, I_C=0$			-0.1	μA
DC current gain	h_{FE}	$V_{CE}=-2\text{V } I_C=-0.1\text{A}$	120		390	
Collector-emitter saturation voltage	$V_{CE(sat)}$	$I_C=-2\text{A } I_B=-0.1\text{A}$			-0.5	V
Transition frequency	f_T	$V_{CE}=-2\text{V}, I_C=-0.5\text{A}, f=100\text{MHz}$		240		MHz
Output Capacitance	C_{obo}	$V_{CB}=-10\text{V } f=1\text{MHz } I_E=0$	-	35		pF

CLASSIFICATION h_{FE}

Rank	Q	R
Range	120-270	180-390
Marking	AEQ	AER

TYPICAL CHARACTERISTICS @ $T_a=25^\circ\text{C}$ unless otherwise specified

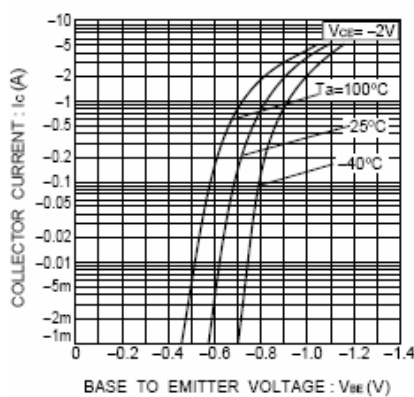

Fig. 1 Grounded emitter propagation characteristics

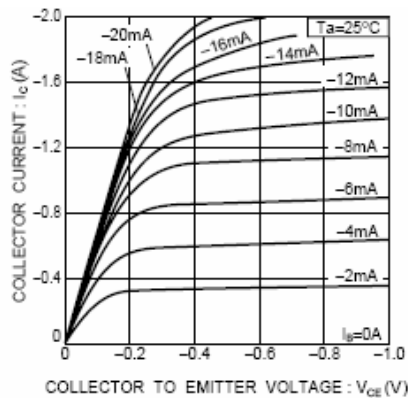

Fig. 2 Grounded emitter output characteristics (I)

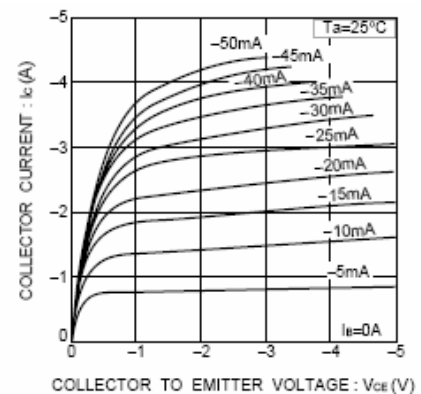

Fig. 3 Grounded emitter output characteristics (II)

Low $V_{CE(sat)}$ Transistor(-20V,-3A)

2SB1424

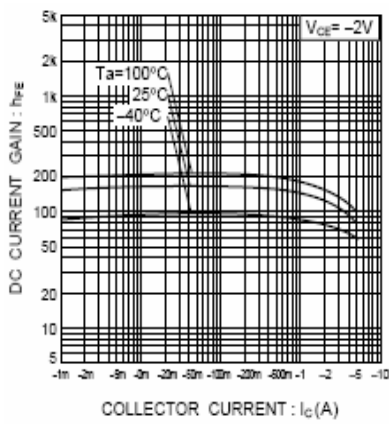

Fig. 4 DC current gain vs. collector current

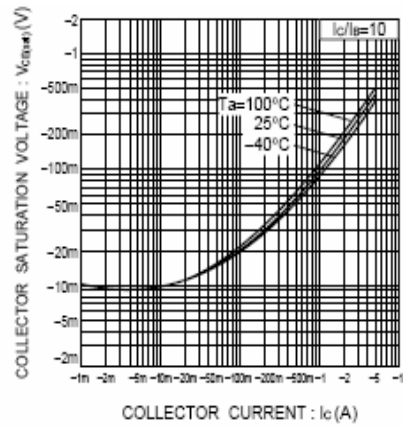

Fig. 5 Collector-emitter saturation voltage vs. collector current (I)

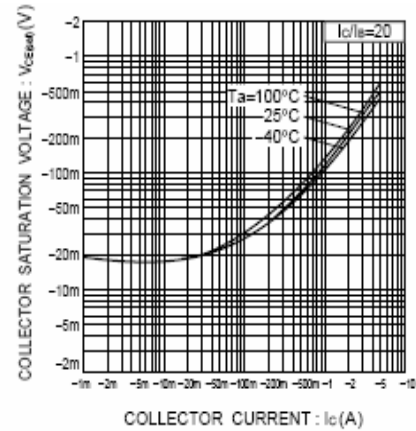

Fig. 6 Collector-emitter saturation voltage vs. collector current (II)

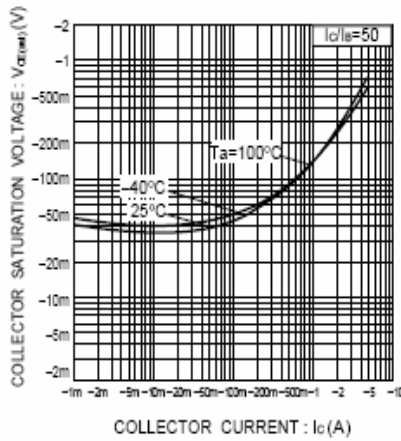

Fig. 7 Collector-emitter saturation voltage vs. collector current (III)

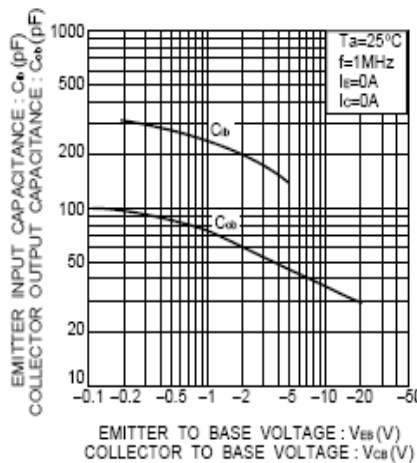

Fig. 8 Gain bandwidth product vs. emitter current
Collector output capacitance vs. collector-base voltage

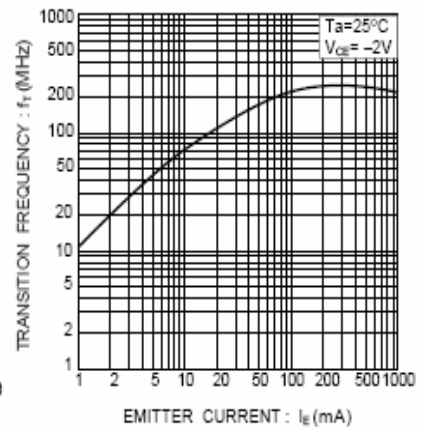

Fig. 9 Emitter input capacitance vs. emitter base voltage



Low $V_{CE(sat)}$ Transistor(-20V,-3A)

2SB1424

PACKAGE OUTLINE

Plastic surface mounted package

SOT-89

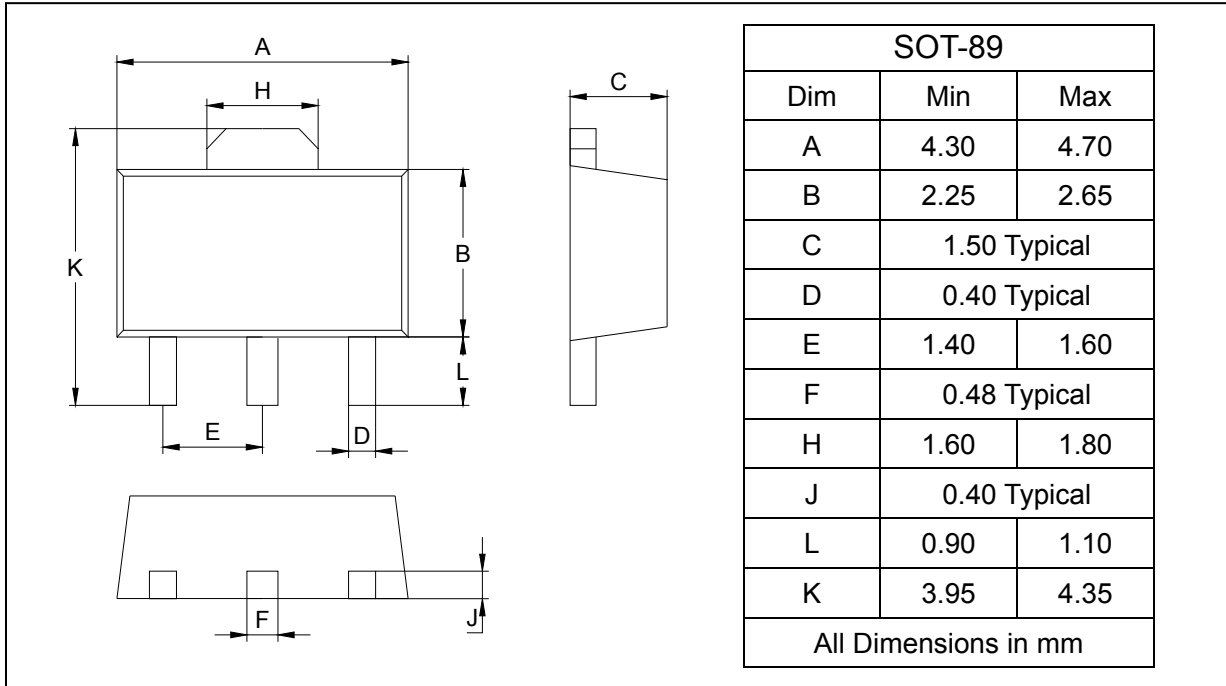

SOLDERING FOOTPRINT

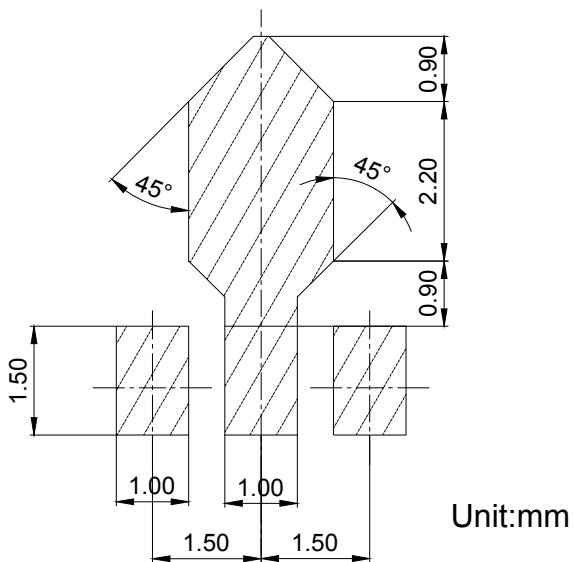

PACKAGE INFORMATION

Device	Package	Shipping
2SB1424	SOT-89	1000/Tape&Reel