



## 2SC1384

## NPN SILICON TRANSISTOR

### NPN SILICON TRANSISTOR

#### DESCRIPTION

The UTC **2SC1384** is power amplifier and driver.

#### FEATURES

\* Low  $V_{CE(SAT)}$

\* 2~3W output in complementary pair with 2SA684

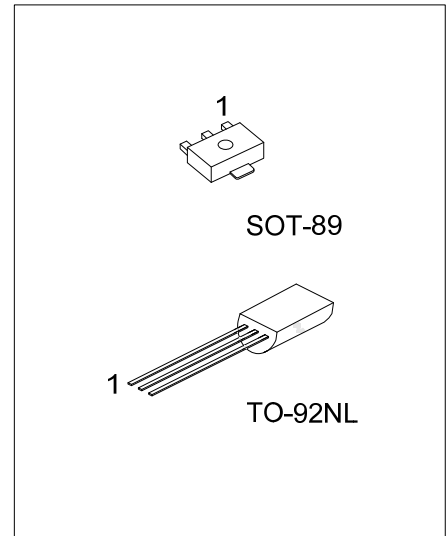

#### ORDERING INFORMATION

Ordering Number		Package	Pin Assignment			Packing
Lead Free	Halogen-Free		1	2	3	
2SC1384L-x-AB3-R	2SC1384G-x-AB3-R	SOT-89	B	C	E	Tape Reel
2SC1384L-x-T9N-B	2SC1384G-x-T9N-B	TO-92NL	E	C	B	Tape Box
2SC1384L-x-T9N-K	2SC1384G-x-T9N-K	TO-92NL	E	C	B	Bulk
2SC1384L-x-T9N-R	2SC1384G-x-T9N-R	TO-92NL	E	C	B	Tape Reel

<p>2SC1384L-x-AB3-B</p> <p>(1)Packing Type (2)Package Type (3)Rank (4)Lead Free</p>	<p>(1) K: Bulk, T: Tube, R: Tape Reel (2) AB3: SOT-89, T9N: TO-92NL (3) x: refer to Classification of <math>h_{FE}</math> (4)G: Halogen Free, L: Lead Free</p>
---	--

■ ABSOLUTE MAXIMUM RATINGS ( $T_A=25^\circ\text{C}$ , unless otherwise specified)

PARAMETER	SYMBOL	RATINGS	UNIT
Collector-Base Voltage	$V_{CBO}$	60	V
Collector-Emitter Voltage	$V_{CEO}$	50	V
Emitter-Base Voltage	$V_{EBO}$	5	V
Peak Collector Current	$I_{CP}$	1.5	A
Collector Current (DC)	$I_C$	1	A
Collector Dissipation ( $T_A=25^\circ\text{C}$ )	$P_C$	1000	mW
Junction Temperature	$T_J$	125	$^\circ\text{C}$
Operating Temperature	$T_{OPR}$	-20 ~ +85	$^\circ\text{C}$
Storage Temperature	$T_{STG}$	-40 ~ +150	$^\circ\text{C}$

Note: Absolute maximum ratings are those values beyond which the device could be permanently damaged.

Absolute maximum ratings are stress ratings only and functional device operation is not implied.

■ ELECTRICAL CHARACTERISTICS ( $T_A=25^\circ\text{C}$ , unless otherwise specified)

PARAMETER	SYMBOL	TEST CONDITIONS	MIN	TYP	MAX	UNIT
Collector-Base Breakdown Voltage	$BV_{CBO}$	$I_C=10\mu\text{A}$ , $I_E=0$	60			V
Collector-Emitter Breakdown Voltage	$BV_{CEO}$	$I_C=2\text{mA}$ , $I_B=0$	50			V
Emitter-Base Breakdown Voltage	$BV_{EBO}$	$I_E=10\mu\text{A}$ , $I_C=0$	5			V
Collector Cut-Off Current	$I_{CBO}$	$V_{CB}=20\text{V}$ , $I_E=0$			0.1	$\mu\text{A}$
DC Current Gain	$h_{FE1}$	$V_{CE}=10\text{V}$ , $I_C=500\text{mA}$	85	160	340	
	$h_{FE2}$	$V_{CE}=5\text{V}$ , $I_C=1\text{A}$	50	100		
Collector-Emitter Saturation Voltage	$V_{CE(SAT)}$	$I_C=0.5\text{A}$ , $I_B=50\text{mA}$		0.2	0.4	V
Base-Emitter Saturation Voltage	$V_{BE(SAT)}$	$I_C=0.5\text{A}$ , $I_B=50\text{mA}$		0.85	1.2	V
Current Gain Bandwidth Product	$f_T$	$V_{CE}=10\text{V}$ , $I_B=50\text{mA}$		200		MHz
Output Capacitance	$C_{OB}$	$V_{CB}=10\text{V}$ , $I_E=0$ , $f=1\text{MHz}$		11	20	pF

■ CLASSIFICATION OF  $h_{FE}$

RANK	Q	R	S
RANGE	85-170	120-240	170-340

## TYPICAL CHARACTERISTICS

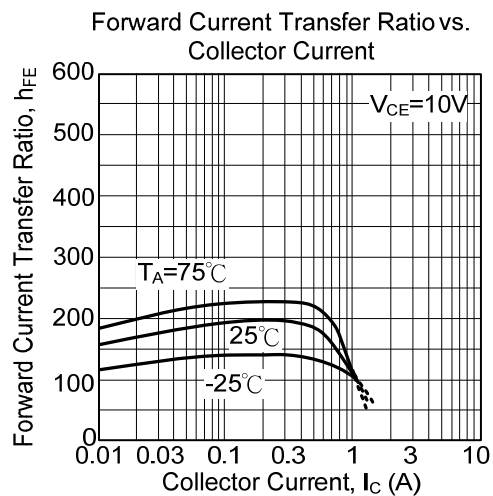
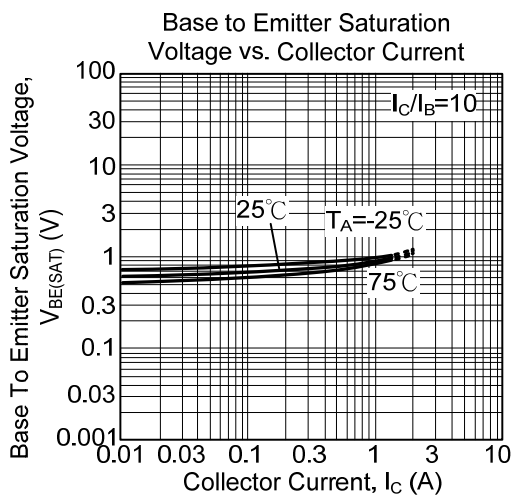
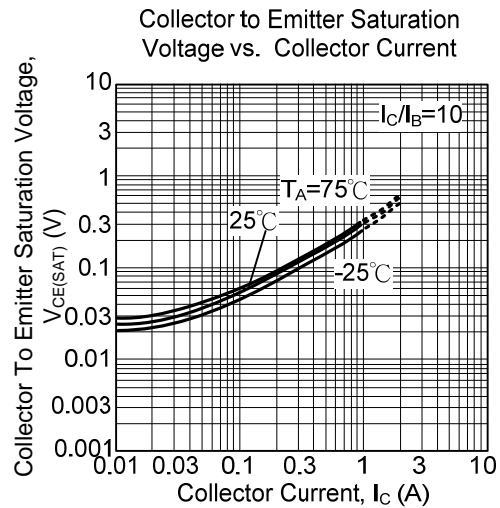
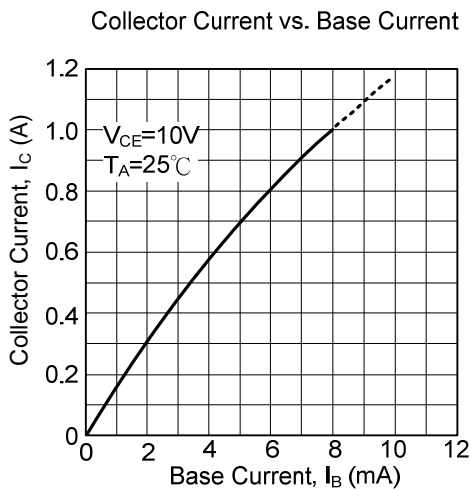
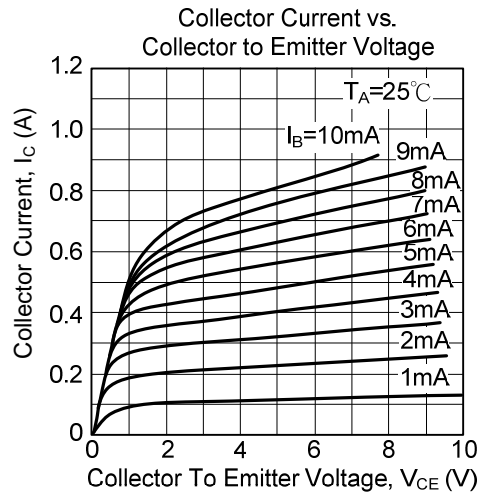
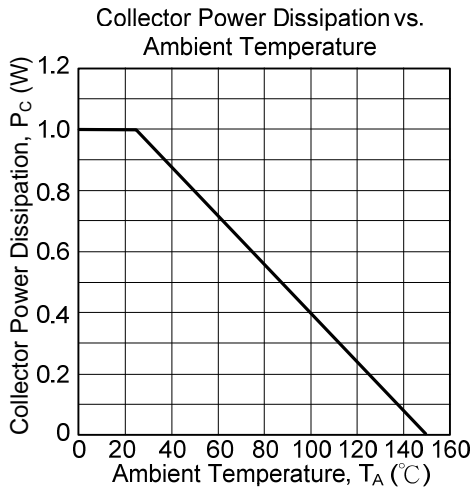

■ TYPICAL CHARACTERISTICS(Cont.)

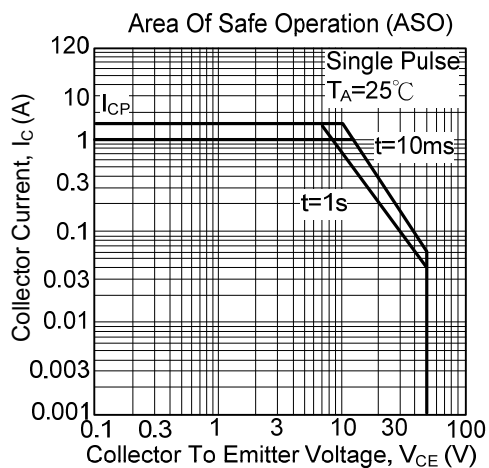
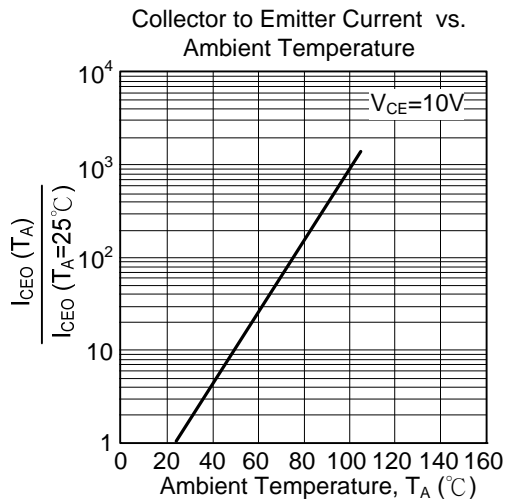
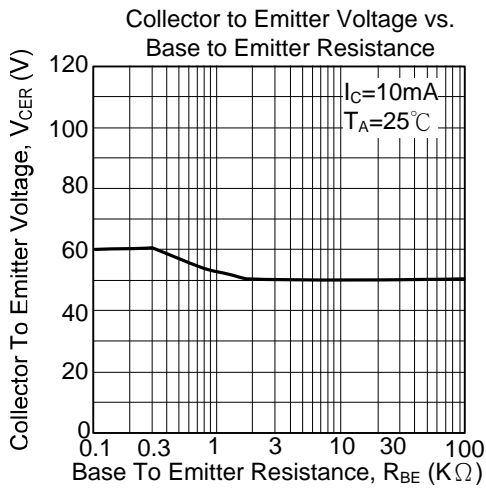
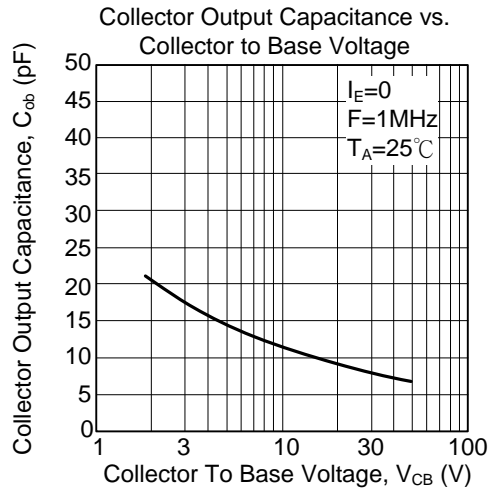
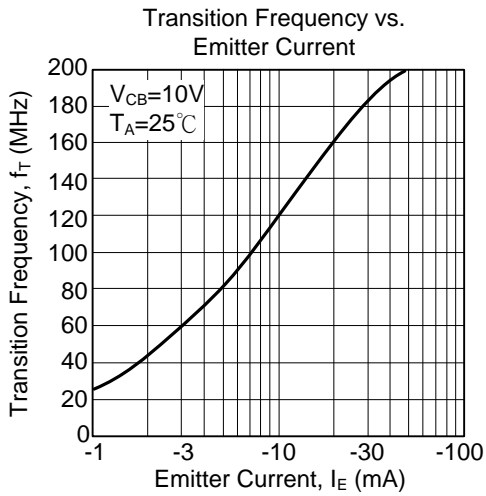

UTC assumes no responsibility for equipment failures that result from using products at values that exceed, even momentarily, rated values (such as maximum ratings, operating condition ranges, or other parameters) listed in products specifications of any and all UTC products described or contained herein. UTC products are not designed for use in life support appliances, devices or systems where malfunction of these products can be reasonably expected to result in personal injury. Reproduction in whole or in part is prohibited without the prior written consent of the copyright owner. The information presented in this document does not form part of any quotation or contract, is believed to be accurate and reliable and may be changed without notice.