

Silicon NPN Power Transistors

2SC1847

DESCRIPTION

- With TO-126 package
- Complement to type 2SA886
- Low collector saturation

APPLICATIONS

- For medium output power amplification

PINNING

PIN	DESCRIPTION
1	Emitter
2	Collector;connected to mounting base
3	Base

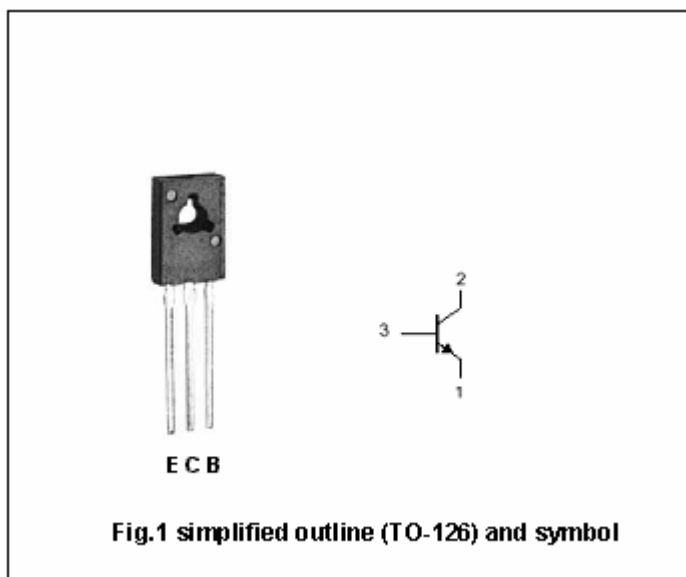

Absolute Maximun Ratings (Ta=25℃)

SYMBOL	PARAMETER	CONDITIONS	VALUE	UNIT
V _{CBO}	Collector-base voltage	Open emitter	50	V
V _{CEO}	Collector-emitter voltage	Open base	40	V
V _{EBO}	Emitter-base voltage	Open collector	5	V
I _C	Collector current (DC)		1.5	A
I _{CM}	Collector current-peak		3	A
P _C	Collector power dissipation	T _C =25℃	1.2* ¹	W
			5* ²	
T _j	Junction temperature		150	℃
T _{stg}	Storage temperature		-55~150	℃

Note) *1: Without heat sink

*2: With a 100 × 100 × 2 mm A1 heat sink

Silicon NPN Power Transistors

2SC1847

CHARACTERISTICS

T_j=25°C unless otherwise specified

SYMBOL	PARAMETER	CONDITIONS	MIN	TYP.	MAX	UNIT
V _{(BR)CEO}	Collector-emitter breakdown voltage	I _C =2mA; I _B =0	40			V
V _{(BR)CBO}	Collector-base breakdown voltage	I _C =1mA; I _E =0	50			V
V _{CEsat}	Collector-emitter saturation voltage	I _C =2A; I _B =0.2A			1.0	V
V _{BEsat}	Base-emitter saturation voltage	I _C =2A; I _B =0.2A			1.5	V
I _{CBO}	Collector cut-off current	V _{CB} =20V; I _E =0			1	μA
I _{CEO}	Collector cut-off current	V _{CE} =10V; I _B =0			100	μA
I _{EBO}	Emitter cut-off current	V _{EB} =5V; I _C =0			10	μA
h _{FE}	DC current gain	I _C =1A; V _{CE} =5V	80		220	
C _{OB}	Output capacitance	I _E =0; V _{CB} =20V; f=1MHz		35		pF
f _T	Transition frequency	I _C =0.5A; V _{CB} =5V; f=200MHz		150		MHz

◆ h_{FE} Classifications

Q	R
80-160	120-220

PACKAGE OUTLINE

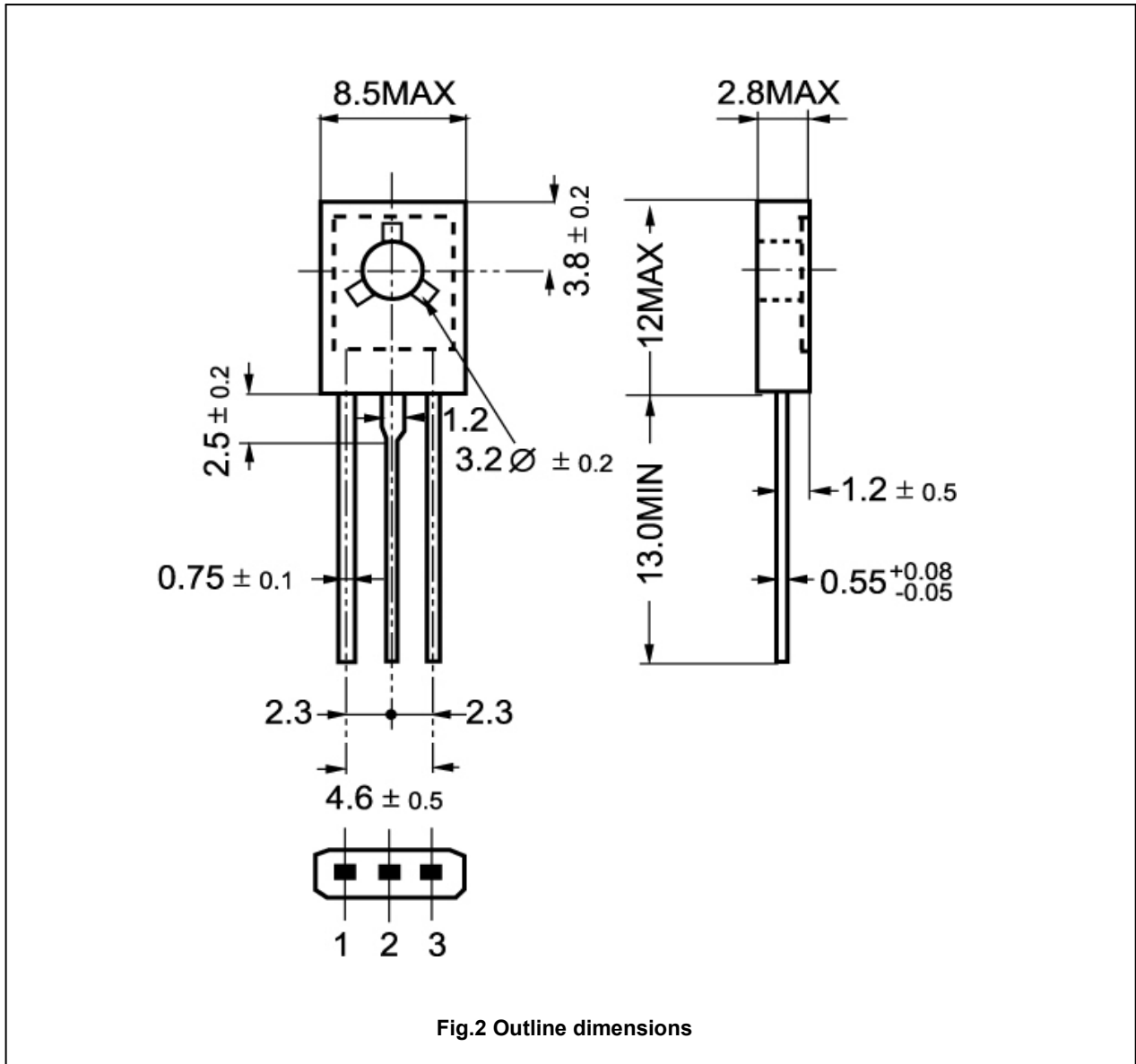

Silicon NPN Power Transistors

2SC1847

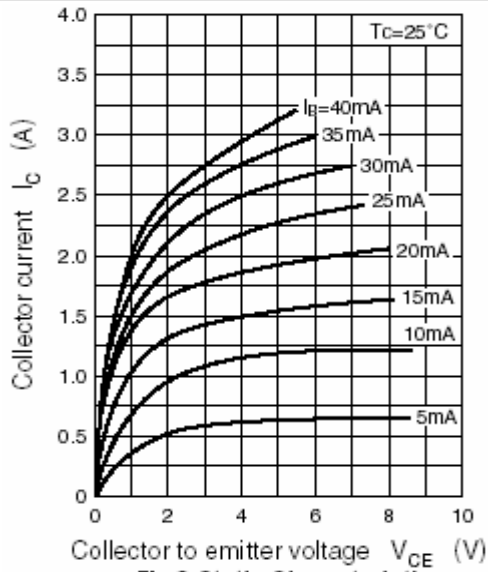

Fig.3 Static Characteristic

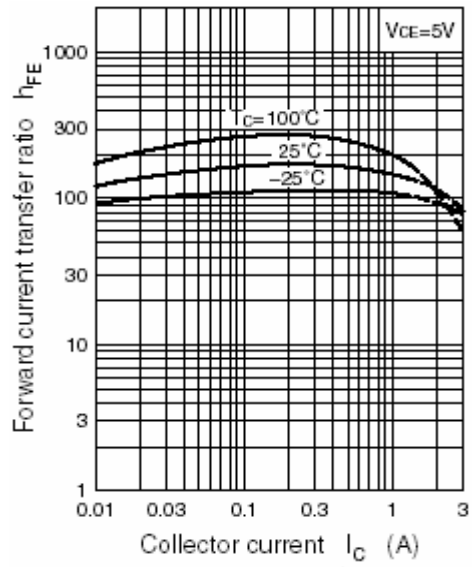

Fig.4 DC current Gain

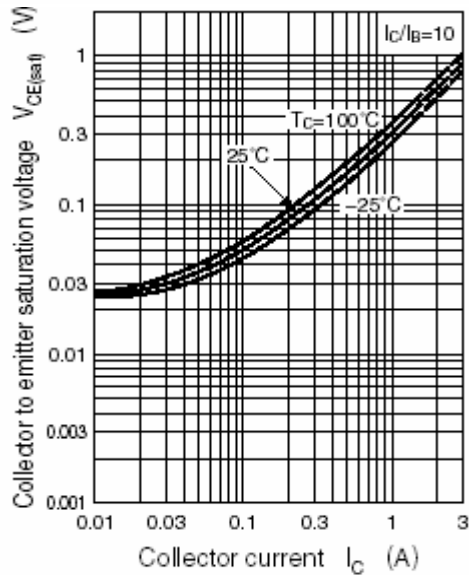

Fig.5 Collector-Emitter Saturation Voltage

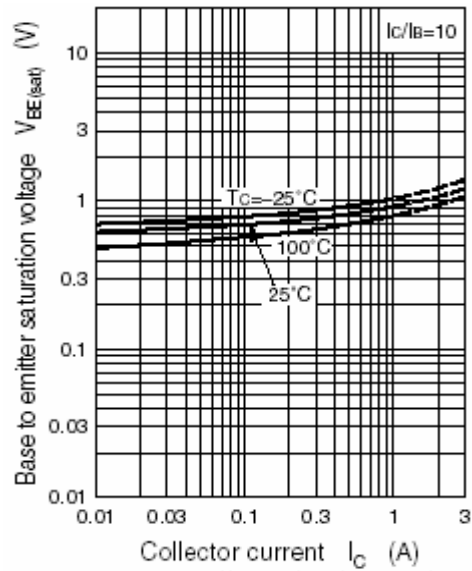

Fig.6 Base-Emitter Saturation Voltage

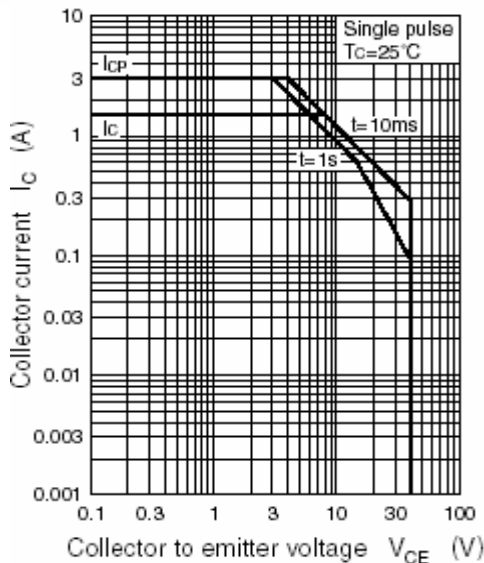

Fig.7 Safe Operating Area