

Silicon NPN Power Transistors

2SC3039

DESCRIPTION

- With TO-220C package
- High breakdown voltage (V_{CBO} 500V).
- Fast switching speed.
- Wide area of safe operation

APPLICATIONS

- 400V/7A switching regulator applications

PINNING

PIN	DESCRIPTION
1	Base
2	Collector;connected to mounting base
3	Emitter

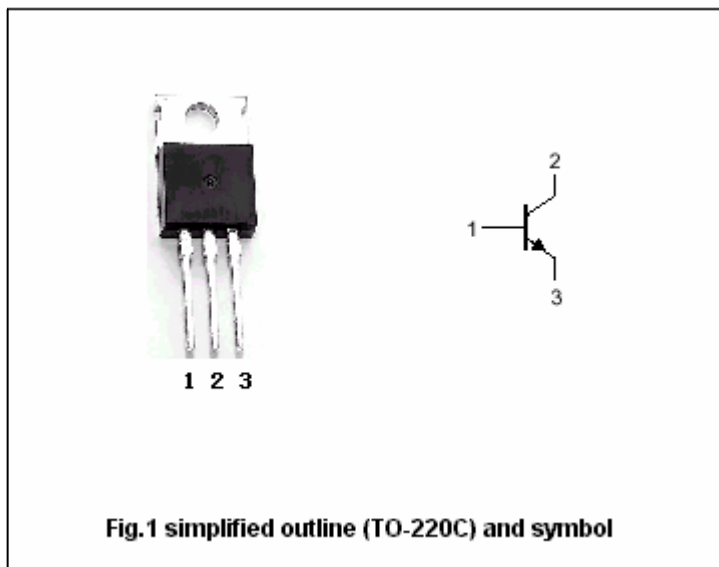

Absolute maximum ratings($T_a=25$)

SYMBOL	PARAMETER	CONDITIONS	VALUE	UNIT
V_{CBO}	Collector-base voltage	Open emitter	500	V
V_{CEO}	Collector-emitter voltage	Open base	400	V
V_{EBO}	Emitter-base voltage	Open collector	7	V
I_C	Collector current (DC)		7	A
I_{CM}	Collector current-peak		14	A
I_B	Base current		3	A
P_C	Collector dissipation	$T_a=25$	1.75	W
		$T_C=25$	50	
T_j	Junction temperature		150	
T_{stg}	Storage temperature		-50~150	

Silicon NPN Power Transistors

2SC3039

CHARACTERISTICS

T_j=25 unless otherwise specified

SYMBOL	PARAMETER	CONDITIONS	MIN	TYP.	MAX	UNIT
V _{(BR)CEO}	Collector-emitter breakdown voltage	I _C =5mA ; R _{BE} =	400			V
V _{(BR)CBO}	Collector-base breakdown voltage	I _C =1mA; I _E =0	500			V
V _{(BR)EBO}	Emitter-base breakdown voltage	I _E =1mA; I _C =0	7			V
V _{CEsat}	Collector-emitter saturation voltage	I _C =4A; I _B =0.8A			1.0	V
V _{BEsat}	Base-emitter saturation voltage	I _C =4A; I _B =0.8A			1.5	V
I _{CBO}	Collector cut-off current	V _{CB} =400V ; I _E =0			10	μ A
I _{EBO}	Emitter cut-off current	V _{EB} =5V; I _C =0			10	μ A
h _{FE-1}	DC current gain	I _C =0.8A ; V _{CE} =5V	15		50	
h _{FE-2}	DC current gain	I _C =4A ; V _{CE} =5V	8			
f _T	Transition frequency	I _C =0.8A ; V _{CE} =10V		20		MHz
C _{ob}	Collector output capacitance	f=1MHz ; V _{CB} =10V		80		pF

Switching times

t _{on}	Turn-on time	I _C =5A, I _{B1} =1A I _{B2} =-1A; V _{CC} =200V R _L =40			1.0	μ s
t _s	Storage time				2.5	μ s
t _f	Fall time				1.0	μ s

◆ h_{FE-1} classifications

L	M	N
15-30	20-40	30-50

PACKAGE OUTLINE

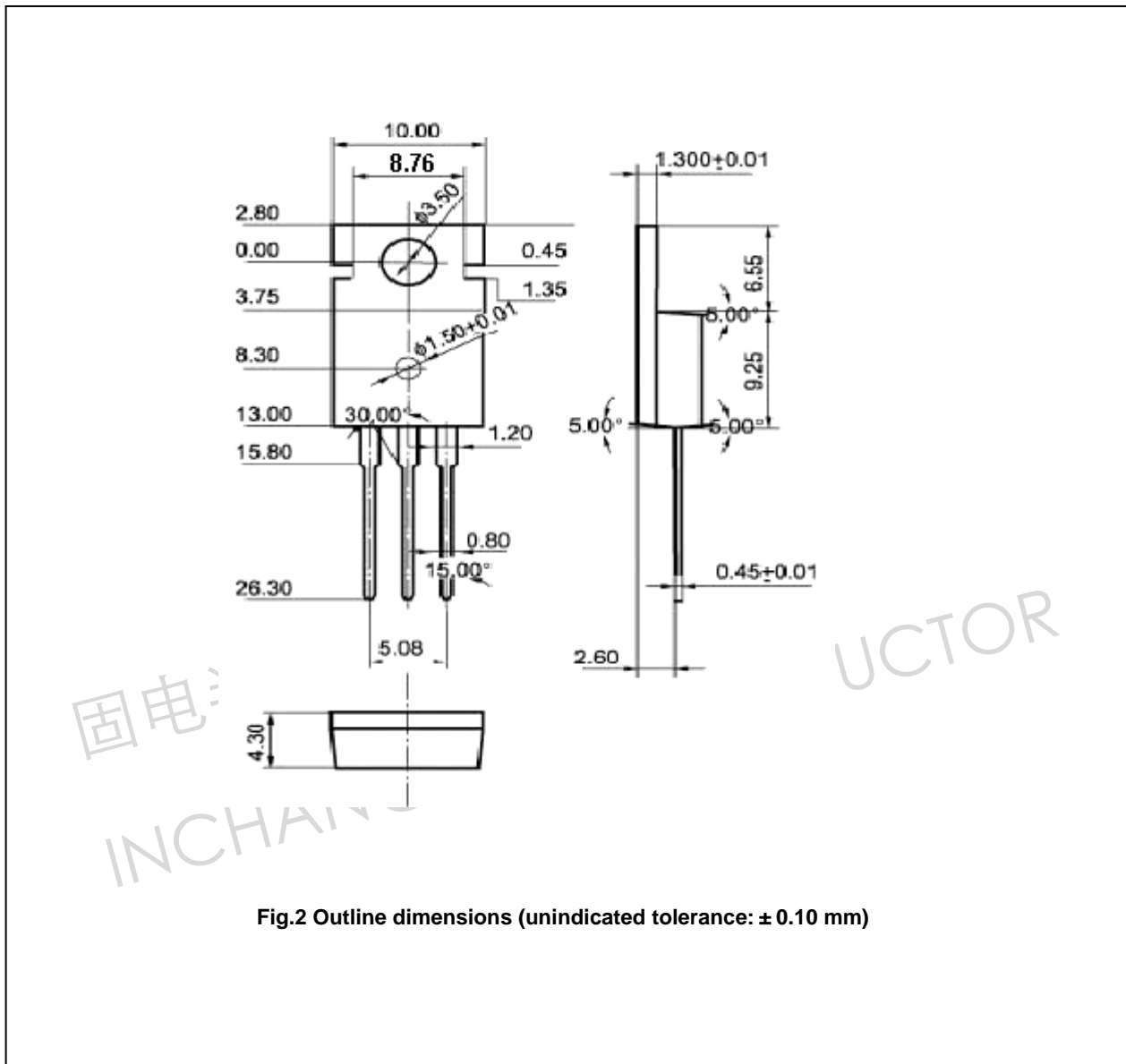

Fig.2 Outline dimensions (unindicated tolerance: ± 0.10 mm)

Silicon NPN Power Transistors

2SC3039

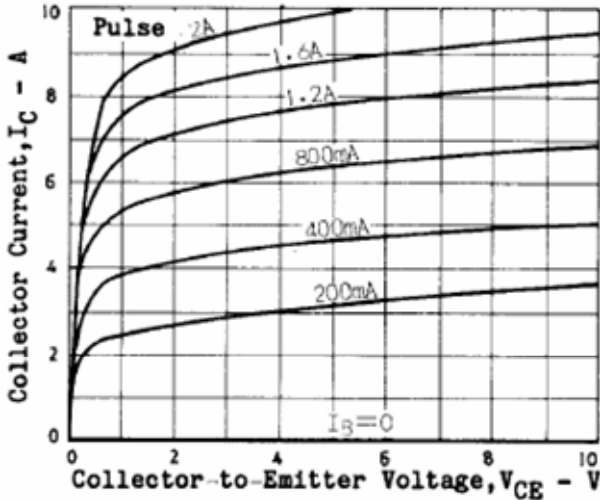

Fig.3 Static Characteristic

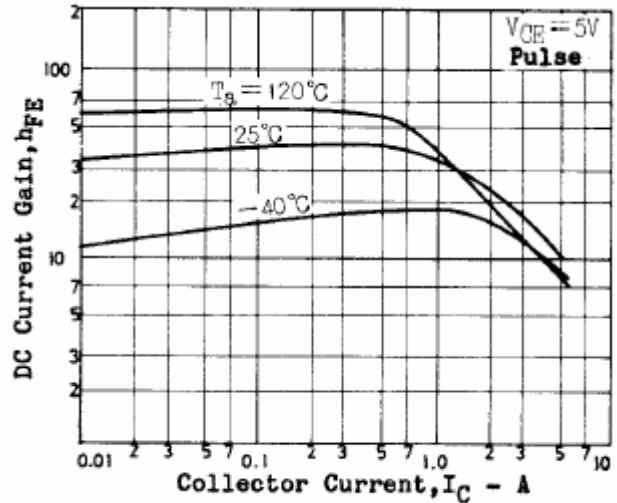

Fig.4 DC current Gain

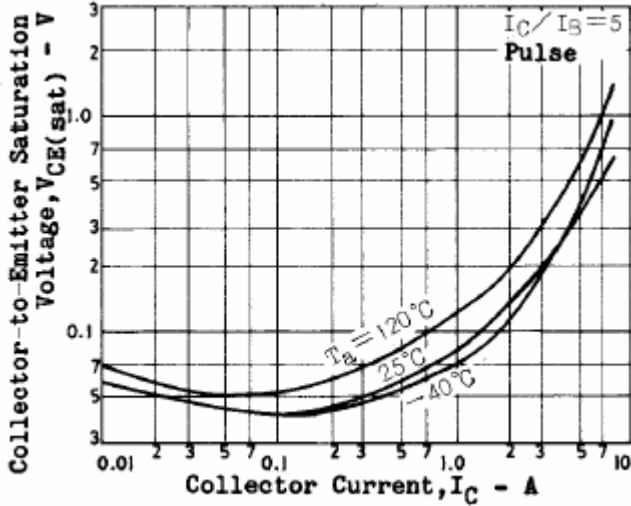

Fig.5 Collector-Emitter Saturation Voltage

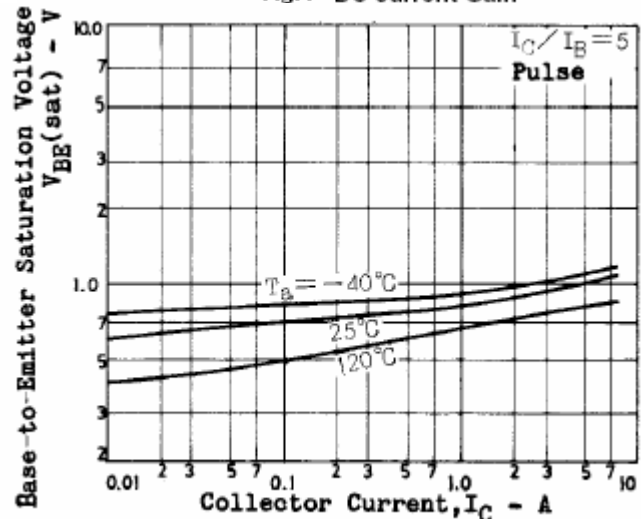

Fig.6 Base-Emitter Saturation Voltage

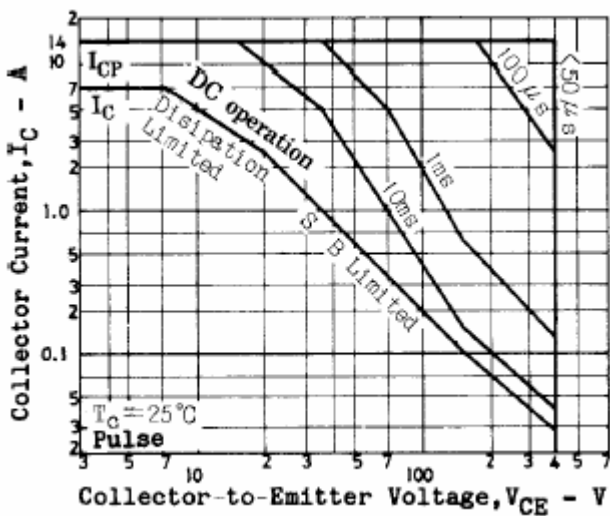

Fig.7 Safe Operating Area