

2SC3211, 2SC3211A

Silicon NPN Triple-Diffused Junction Mesa Type

High Breakdown Voltage, High Speed Switching

■ Features

- High speed switching
- High collector-base voltage (V_{CB0})
- Low collector-emitter saturation voltage ($V_{CE(sat)}$)
- "Full Pack" package for simplified mounting on a heat sink with one screw

■ Absolute Maximum Ratings ($T_c=25^\circ\text{C}$)

Item	Symbol	Value	Unit
Collector-base voltage	2SC3211	800	V
	2SC3211A		
Collector-emitter voltage	V_{CE0}	500	V
Emitter-base voltage	V_{EBO}	8	V
Peak collector current	I_{CP}	10	A
Collector current	I_C	5	A
Base current	I_B	3	A
Collector power dissipation	$T_c=25^\circ\text{C}$	P_C	W
	$T_a=25^\circ\text{C}$		
Junction temperature	T_j	150	$^\circ\text{C}$
Storage temperature	T_{stg}	-55 ~ +150	$^\circ\text{C}$

■ Package Dimensions

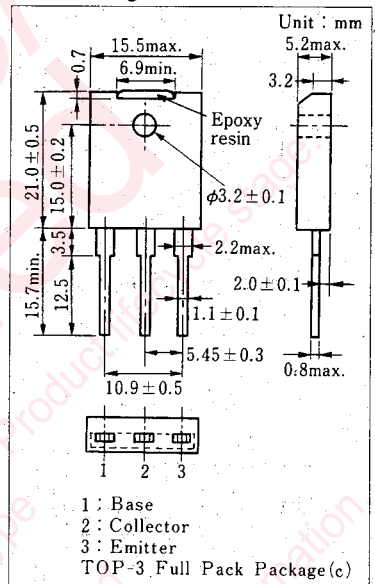

■ Electrical Characteristics ($T_c=25^\circ\text{C}$)

Item	Symbol	Condition	min.	typ.	max.	Unit
Collector cutoff current	2SC3211	$V_{CB}=800\text{ V}, I_E=0$			100	μA
	2SC3211A					
Emitter cutoff current	I_{EBO}	$V_{EB}=5\text{ V}, I_C=0$			100	μA
Collector-emitter voltage	$V_{CE0(sus)}$	$I_C=0.2\text{ A}, L=25\text{ mH}$	500			V
DC current gain	h_{FE1}	$V_{CE}=5\text{ V}, I_C=0.1\text{ A}$	15			
	h_{FE2}	$V_{CE}=5\text{ V}, I_C=3\text{ A}$	8			
Collector-emitter saturation voltage	$V_{CE(sat)}$	$I_C=3\text{ A}, I_B=0.6\text{ A}$			1	V
Base-emitter saturation voltage	$V_{BE(sat)}$	$I_C=3\text{ A}, I_B=0.6\text{ A}$			1.5	V
Transition frequency	f_T	$V_{CE}=10\text{ V}, I_C=0.5\text{ A}, f=1\text{ MHz}$		3		MHz
Turn-on time	2SC3211	t_{on}	$I_C=3\text{ A}$		1	μs
	2SC3211A					
Storage time	t_{stg}	$I_{B1}=0.6\text{ A}, I_{B2}=-0.6\text{ A}$			3	μs
Collector current fall time	2SC3211	t_f	$V_{CC}=200\text{ V}$		1	μs
	2SC3211A					

$P_C - T_a$

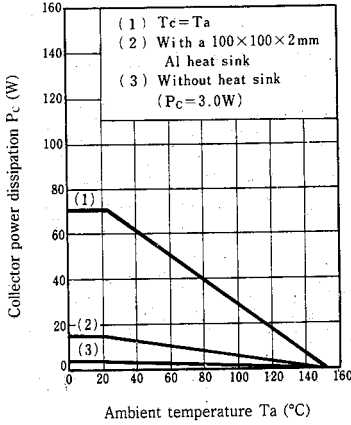

$I_C - V_{CE}$

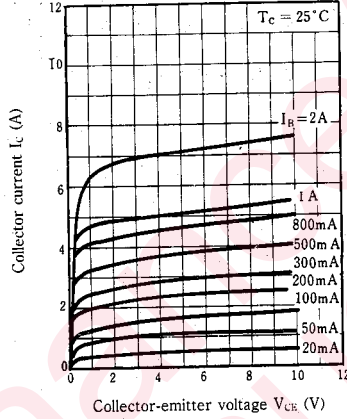

$V_{CE(sat)} - I_C$

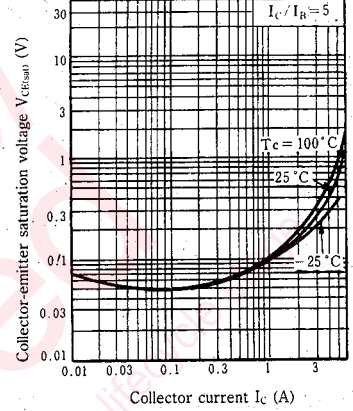

$V_{BE(sat)} - I_C$

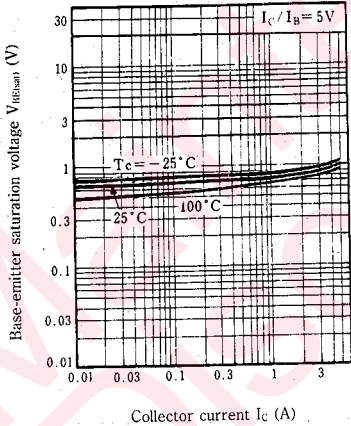

$h_{FE} - I_C$

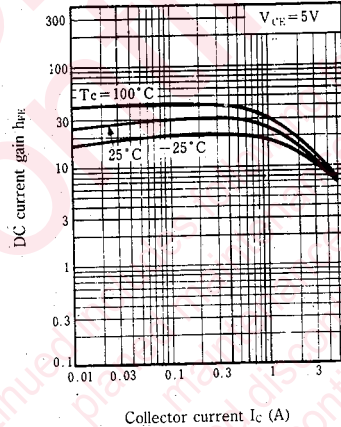

$f_T - I_C$

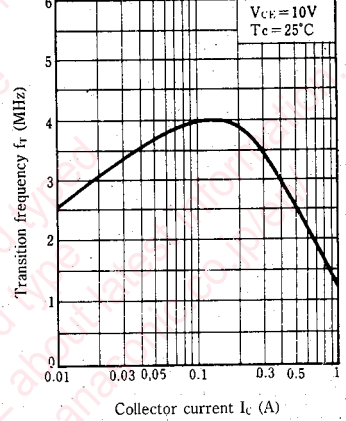

$C_{ob} - V_{CB}$

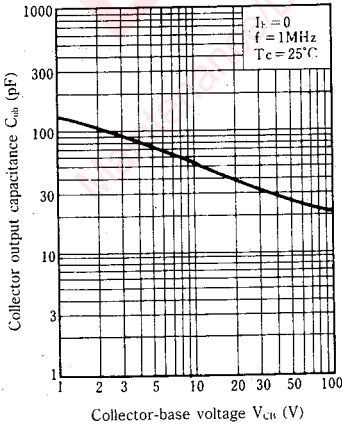

$t_{on}, t_{stg}, t_f - I_C$

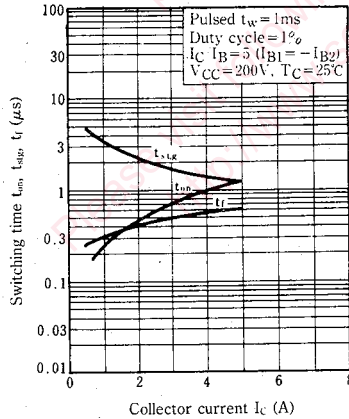

Safety operation area-forward bias (ASO)

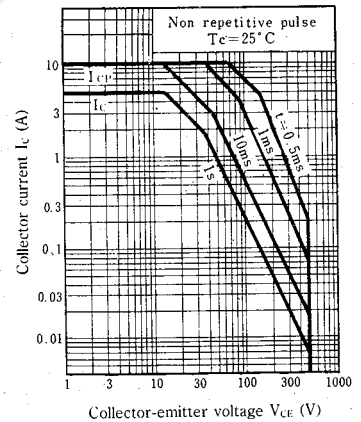

Safety operation area-reverse bias (ASO)

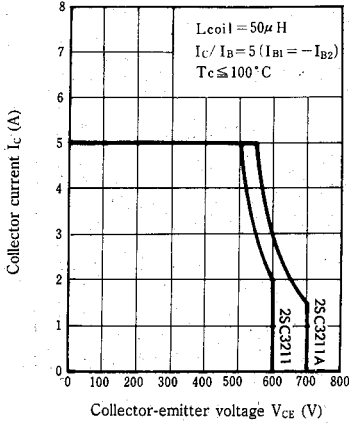

Measurement circuit of reverse bias ASO

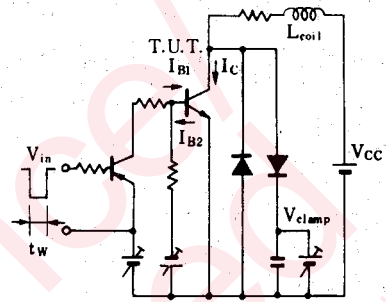

$R_{th}(t) - t$

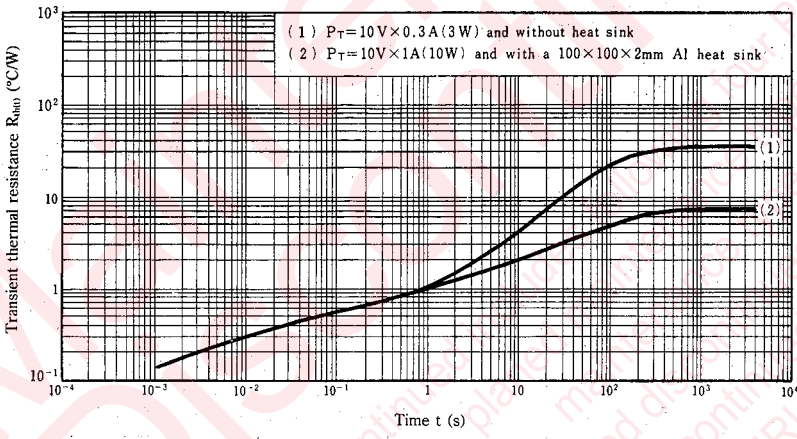

Request for your special attention and precautions in using the technical information and semiconductors described in this book

- (1) If any of the products or technical information described in this book is to be exported or provided to non-residents, the laws and regulations of the exporting country, especially, those with regard to security export control, must be observed.
- (2) The technical information described in this book is intended only to show the main characteristics and application circuit examples of the products. No license is granted in and to any intellectual property right or other right owned by Panasonic Corporation or any other company. Therefore, no responsibility is assumed by our company as to the infringement upon any such right owned by any other company which may arise as a result of the use of technical information described in this book.
- (3) The products described in this book are intended to be used for standard applications or general electronic equipment (such as office equipment, communications equipment, measuring instruments and household appliances).
Consult our sales staff in advance for information on the following applications:
 - Special applications (such as for airplanes, aerospace, automobiles, traffic control equipment, combustion equipment, life support systems and safety devices) in which exceptional quality and reliability are required, or if the failure or malfunction of the products may directly jeopardize life or harm the human body.
 - Any applications other than the standard applications intended.
- (4) The products and product specifications described in this book are subject to change without notice for modification and/or improvement. At the final stage of your design, purchasing, or use of the products, therefore, ask for the most up-to-date Product Standards in advance to make sure that the latest specifications satisfy your requirements.
- (5) When designing your equipment, comply with the range of absolute maximum rating and the guaranteed operating conditions (operating power supply voltage and operating environment etc.). Especially, please be careful not to exceed the range of absolute maximum rating on the transient state, such as power-on, power-off and mode-switching. Otherwise, we will not be liable for any defect which may arise later in your equipment.
 - Even when the products are used within the guaranteed values, take into the consideration of incidence of break down and failure mode, possible to occur to semiconductor products. Measures on the systems such as redundant design, arresting the spread of fire or preventing glitch are recommended in order to prevent physical injury, fire, social damages, for example, by using the products.
- (6) Comply with the instructions for use in order to prevent breakdown and characteristics change due to external factors (ESD, EOS, thermal stress and mechanical stress) at the time of handling, mounting or at customer's process. When using products for which damp-proof packing is required, satisfy the conditions, such as shelf life and the elapsed time since first opening the packages.
- (7) This book may be not reprinted or reproduced whether wholly or partially, without the prior written permission of our company.