

# 2SC3455



2017

NPN Triple Diffused Planar Silicon Transistor

## Switching Regulator Applications

©1578B

### Features

- High breakdown voltage and high reliability
- Fast switching speed ( $t_f$ : 0.1us typ.)
- Wide ASO
- Adoption of MBIT process

### Absolute Maximum Ratings at $T_a=25^\circ\text{C}$

			unit
Collector to Base Voltage	VCBO	800	V
Collector to Emitter Voltage	VCEO	500	V
Emitter to Base Voltage	VEBO	7	V
Collector Current	IC	25	A
Peak Collector Current	icp	$PW \leq 300\mu\text{s}$ , Duty Cycle $\leq 10\%$	A
Base Current	IB	8	A
Collector Dissipation	PC	$T_c=25^\circ\text{C}$	W
Junction Temperature	Tj	150	$^\circ\text{C}$
Storage Temperature	Tstg	-55 to +150	$^\circ\text{C}$

### Electrical Characteristics at $T_a=25^\circ\text{C}$

			min	typ	max	unit
Collector Cutoff Current	ICBO	$V_{CB}=500\text{V}, I_E=0$			10	$\mu\text{A}$
Emitter Cutoff Current	IEBO	$V_{EB}=5\text{V}, I_C=0$			10	$\mu\text{A}$
DC Current Gain	hFE(1)	$V_{CE}=5\text{V}, I_C=2.4\text{A}$	15*		50*	
		$V_{CE}=5\text{V}, I_C=12\text{A}$	8			
Gain Bandwidth Product	fT	$V_{CE}=10\text{V}, I_C=2.4\text{A}$		18		MHz
Output Capacitance	Cob	$V_{CB}=10\text{V}, f=1\text{MHz}$		320		pF
C-E Saturation Voltage	VCE(sat)	$I_C=12\text{A}, I_B=2.4\text{A}$			1.0	V
B-E Saturation Voltage	VBE(sat)	$I_C=12\text{A}, I_B=2.4\text{A}$			1.5	V
C-B Breakdown Voltage	V(BR)CBO	$I_C=1\text{mA}, I_E=0$	800			V
C-E Breakdown Voltage	V(BR)CEO	$I_C=5\text{mA}, R_{BE}=\infty$	500			V
E-B Breakdown Voltage	V(BR)EBO	$I_E=1\text{mA}, I_C=0$	7			V

Continued on next page.

\*: The  $h_{FE}(1)$  of the 2SC3455 is classified by 2.4A  $h_{FE}$  as follows. When specifying the  $h_{FE}(1)$  rank, specify two ranks or more in principle.

15	L	30	20	M	40	30	N	50
----	---	----	----	---	----	----	---	----

### Case Outline 2017 (unit:mm)

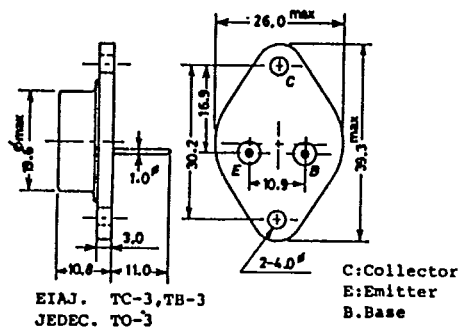

4227KI/3085KI/6154KI, MT No. 1578-1/3

2SC3455

T-33-15

Continued from preceding page.

			min	typ	max	unit
C-E Sustain Voltage	VCEX(sus)	IC=10A, IB1=-IB2=4A, L=200uH, Clamped	500			V
Turn-on Time	ton	[VCC=200V, 5IB1=-2.5IB2=IC=14A, RL=14.3ohm]			0.5	us
Storage Time	tstg				3.0	us
Fall Time	tf				0.3	us

Switching Time Test Circuit

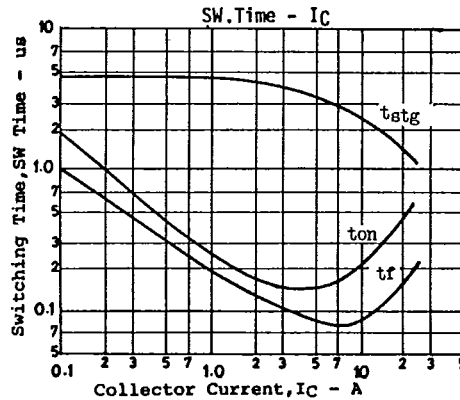
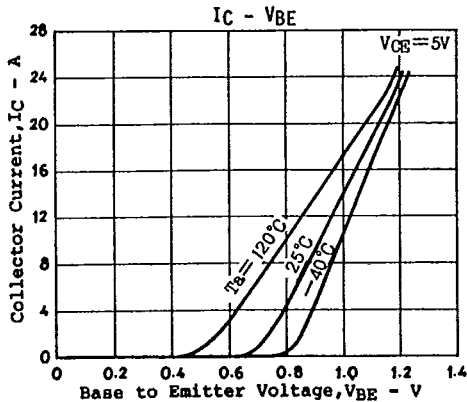
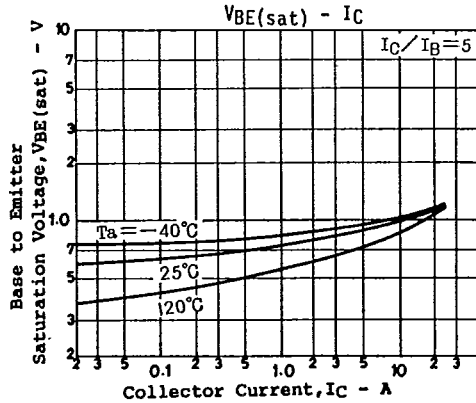
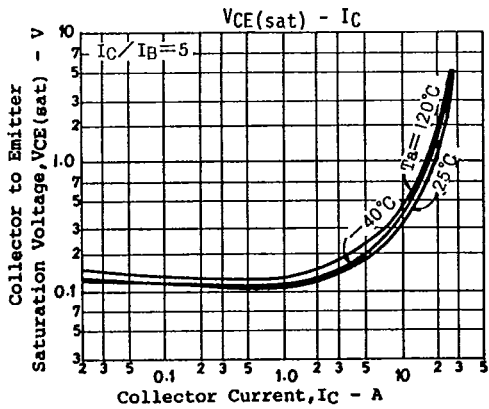
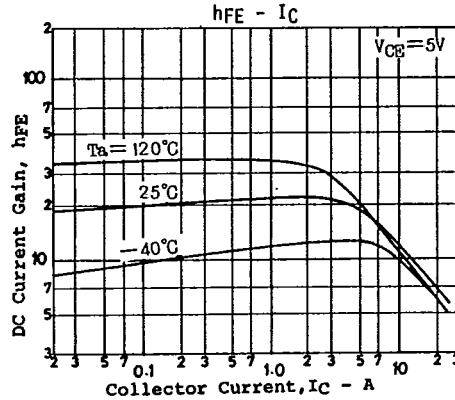
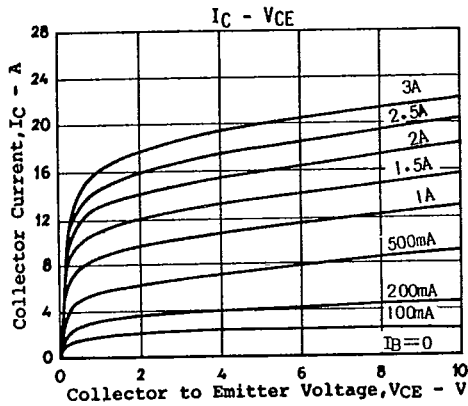
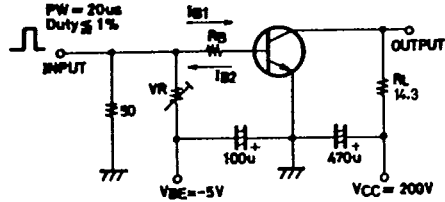

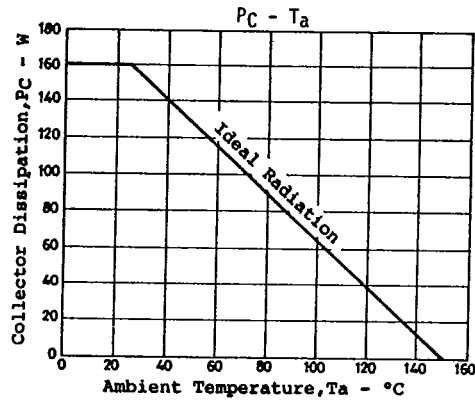
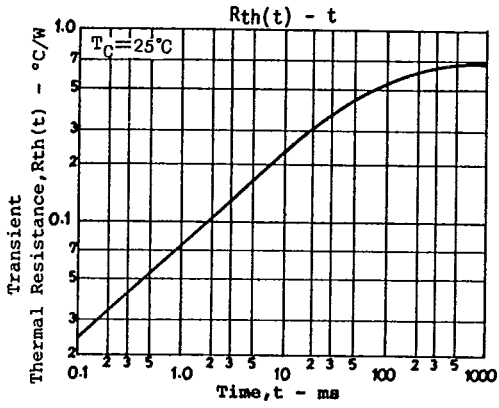
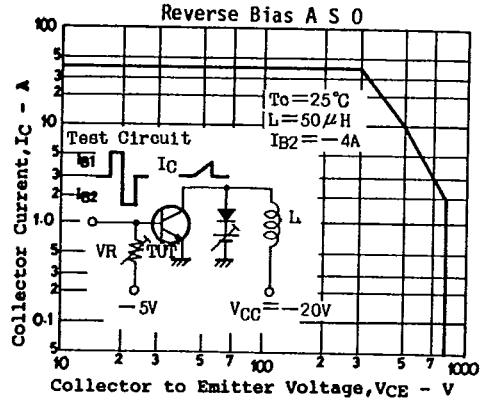
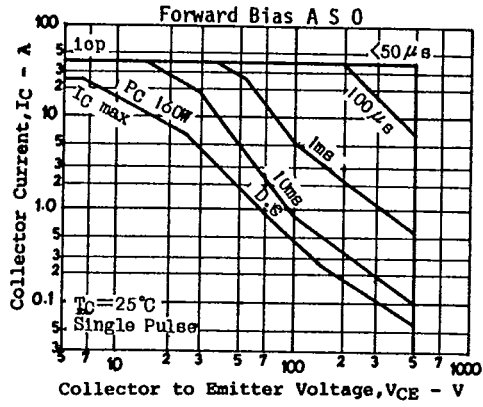

T-91-20

# CASE OUTLINES AND ATTACHMENTS

- All of Sanyo Transistor case outlines are illustrated below.
- All dimensions are in mm, and dimensions which are not followed by min. or max. are represented by typical values.
- No marking is indicated.

Case Outline-[2003A]

unit:mm

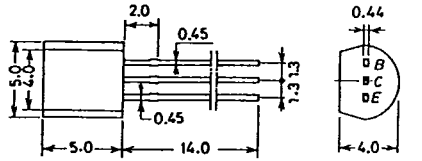

JEDEC: TO-92  
EIAJ: SC-43  
SANYO: NP

B. Base  
C. Collector  
E. Emitter

Case Outline-[2009A]

unit:mm

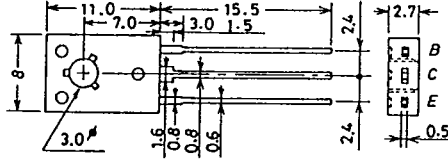

JEDEC: TO-126

B: Base  
C: Collector  
E: Emitter

Case Outline-[2004A]

unit:mm

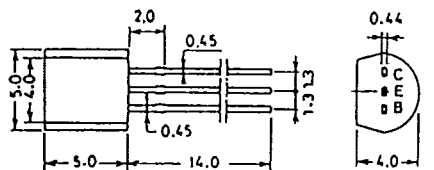

JEDEC: TO-92  
EIAJ: SC-43  
SANYO: NP

C. Collector  
E. Emitter  
B. Base

Case Outline-[2010A]

unit:mm

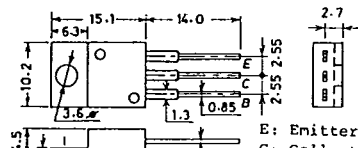

JEDEC: TO-220AB  
EIAJ: SC-46

E: Emitter  
C: Collector  
B: Base

Case Outline-[2005A]

unit:mm

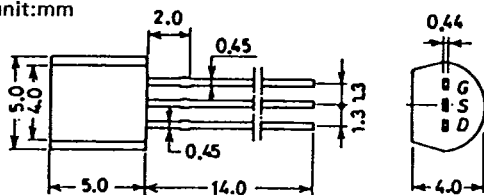

JEDEC: TO-92  
EIAJ: SC-43  
SANYO: NP

G: Gate  
S: Source  
D: Drain  
B: Base  
C: Collector

Case Outline-[2012]

unit:mm

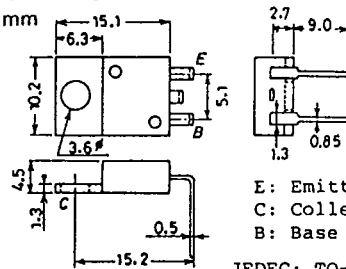

JEDEC: TO-220AA  
EIAJ: SC-45

E: Emitter  
C: Collector  
B: Base

Case Outline-[2006A]

unit:mm

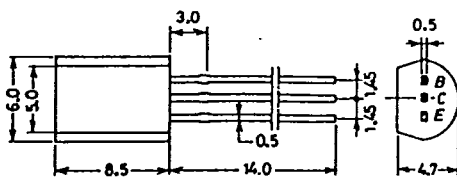

EIAJ: SC-51  
SANYO: MP

B: Base  
C: Collector  
E: Emitter

Case Outline-[2013]

unit:mm

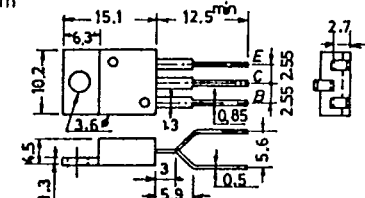

JEDEC TO-220

B: Base  
C: Collector  
E: Emitter

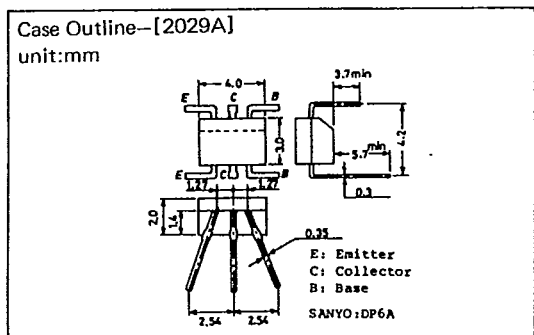
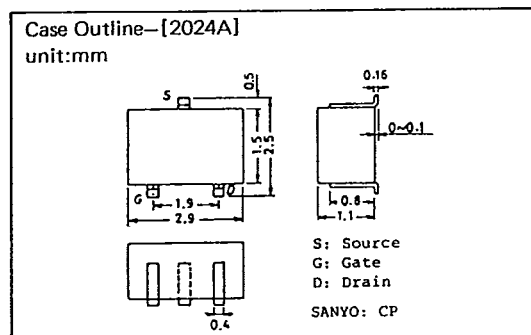
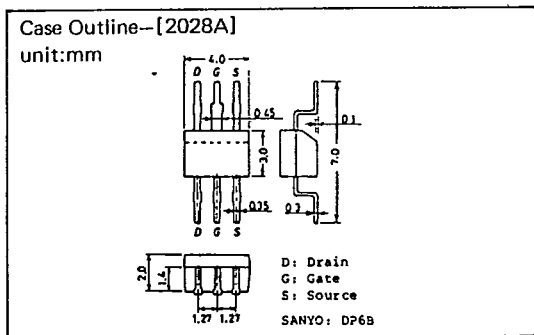
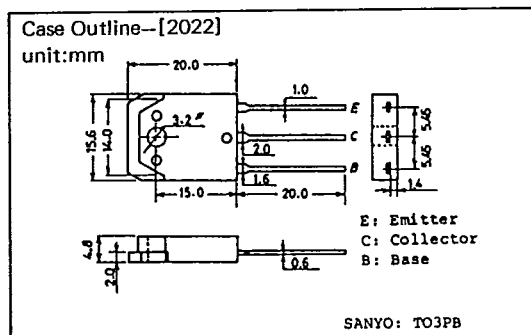
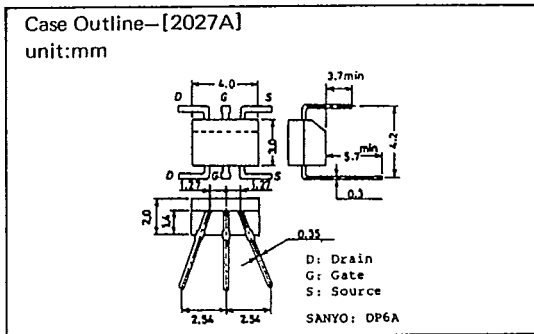
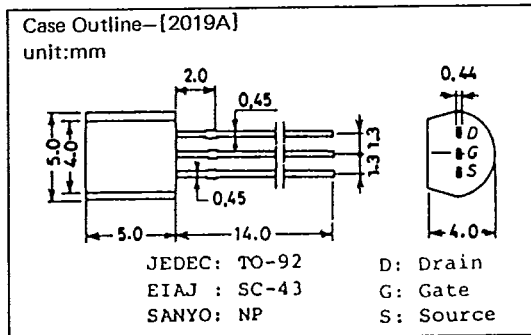
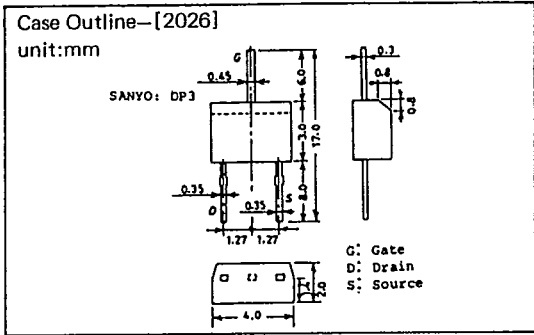
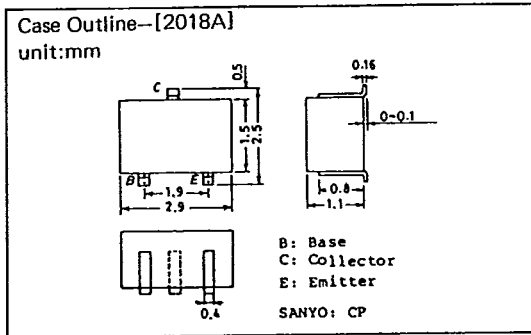
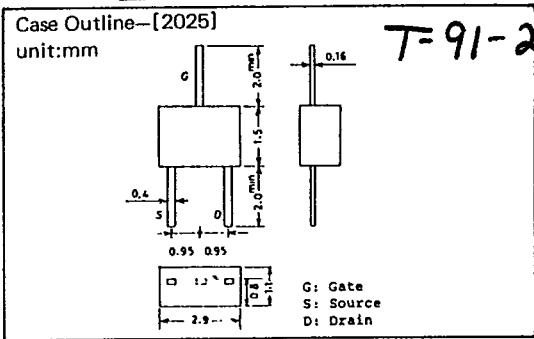
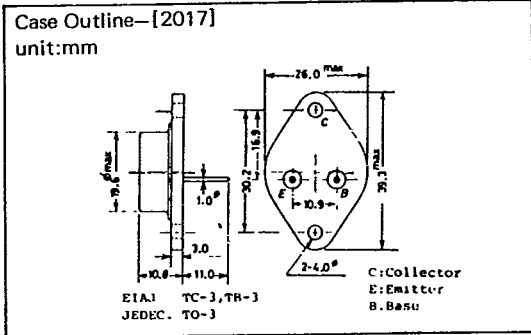

T-91-20

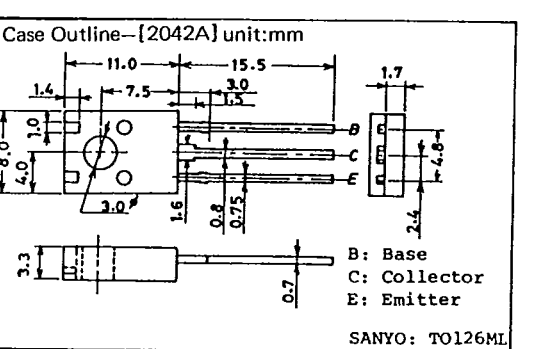
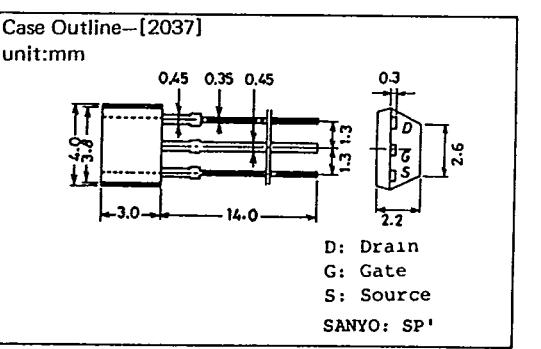
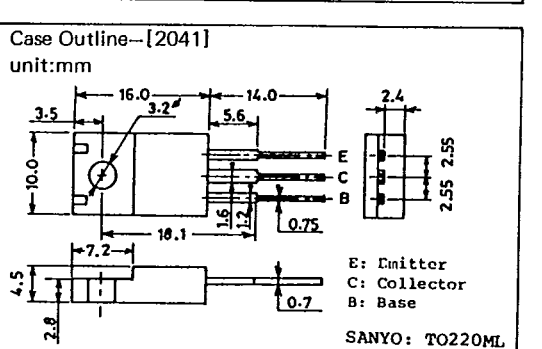
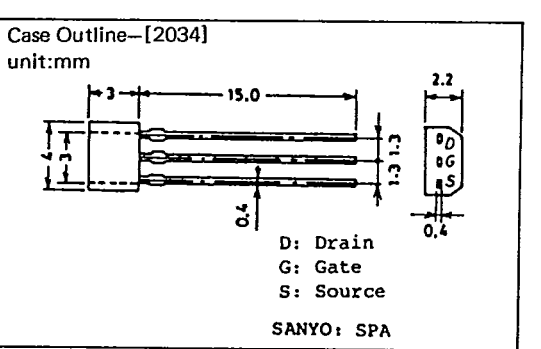
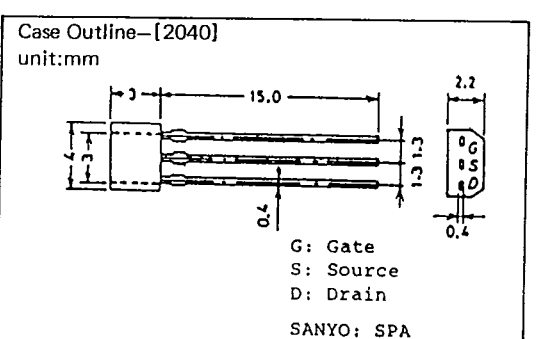
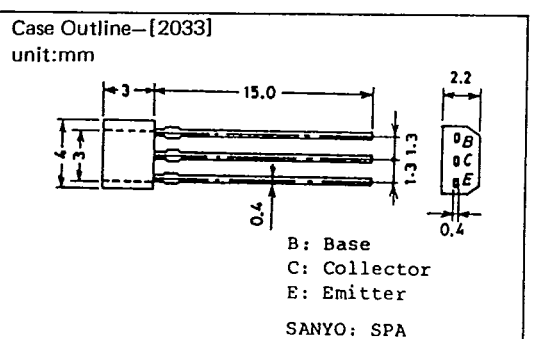
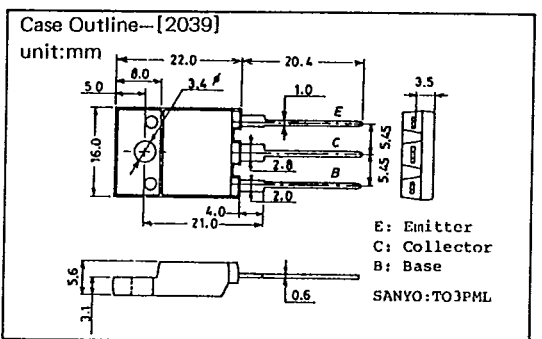
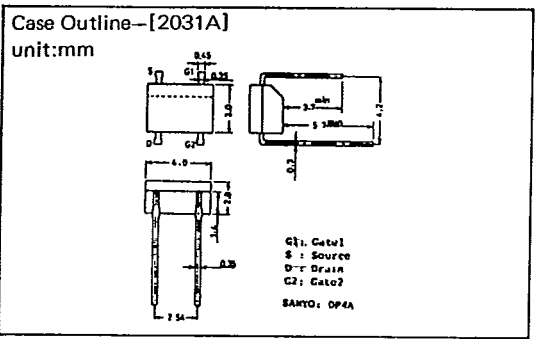
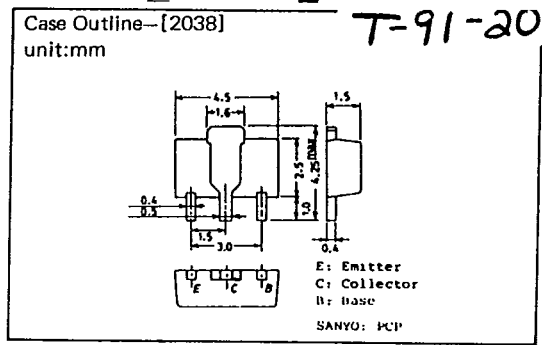
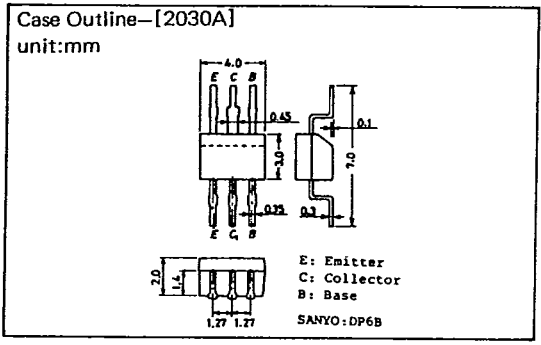

T-91-20

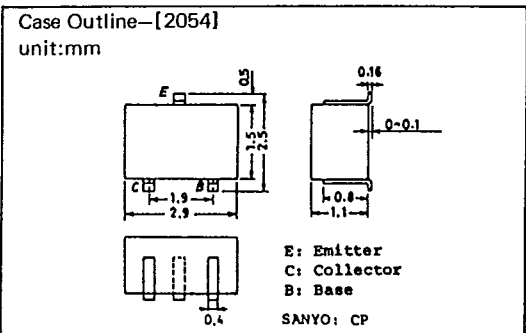
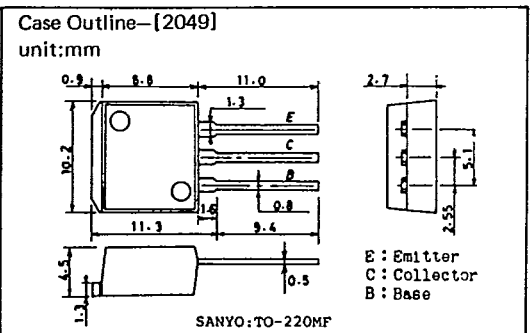
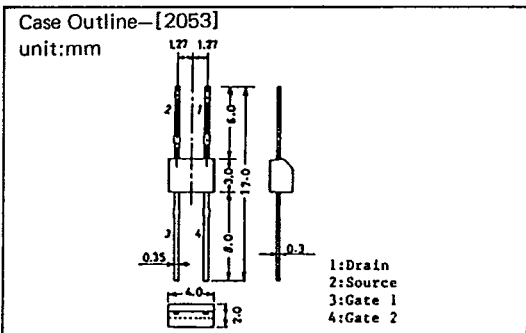
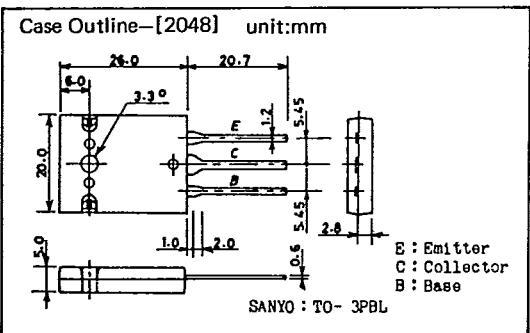
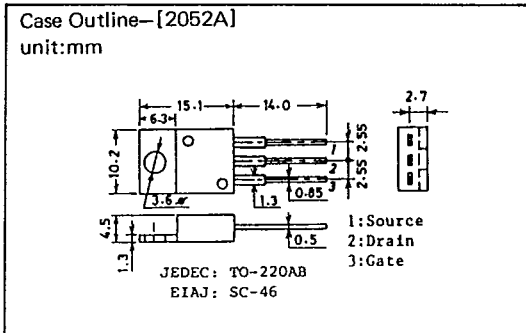
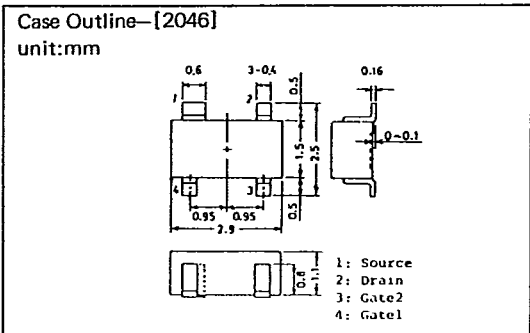
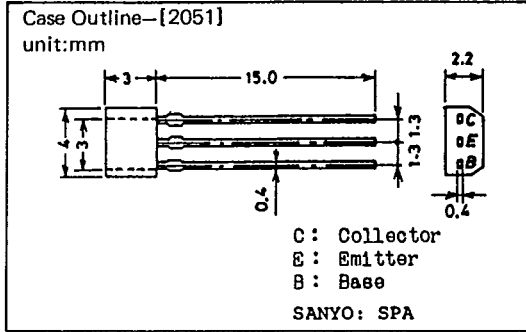
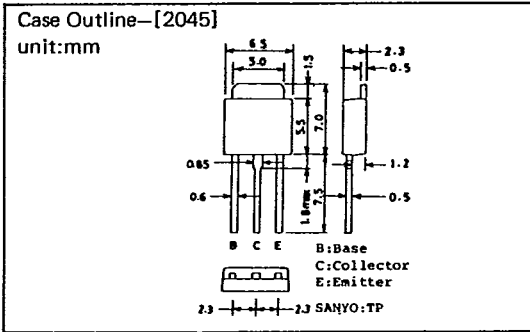
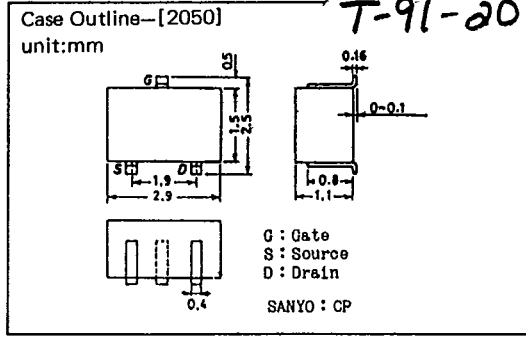
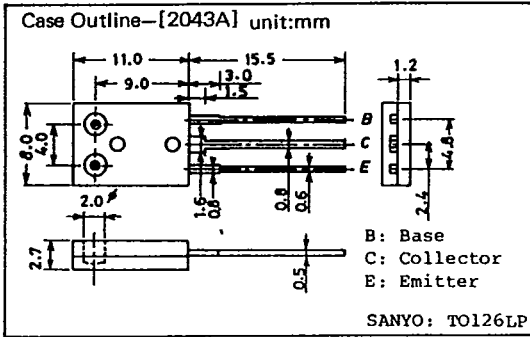

T-91-20

