

NPN SILICON POWER TRANSISTOR 2SC3570

DESCRIPTION The 2SC3570 is NPN silicon epitaxial transistor designed for switching regulator, DC-DC converter and high frequency power amplifier application.

FEATURES

- Easy mount by eliminating Insulation Sheet and Bushing.
- Low Collector Saturation Voltage.
- High Switching Speed.

ABSOLUTE MAXIMUM RATINGS

Maximum Temperatures

Storage Temperature -55 to +150 °C

Junction Temperature 150 °C Maximum

Maximum Power Dissipation (T_c = 25 °C)

Total Power Dissipation 25 W

Maximum Voltages and Currents (T_a = 25 °C)

V_{CB0} Collector to Base Voltage 500 V

V_{CEO} Collector to Emitter Voltage 400 V

V_{EBO} Emitter to Base Voltage 8.0 V

I_{C(DC)} Collector Current (DC) 5.0 A

I_{C(pulse)} Collector Current (pulse)* 10 A

I_{B(DC)} Base Current (DC) 2.5 A

* PW ≤ 300 μs, Duty Cycle ≤ 10 %

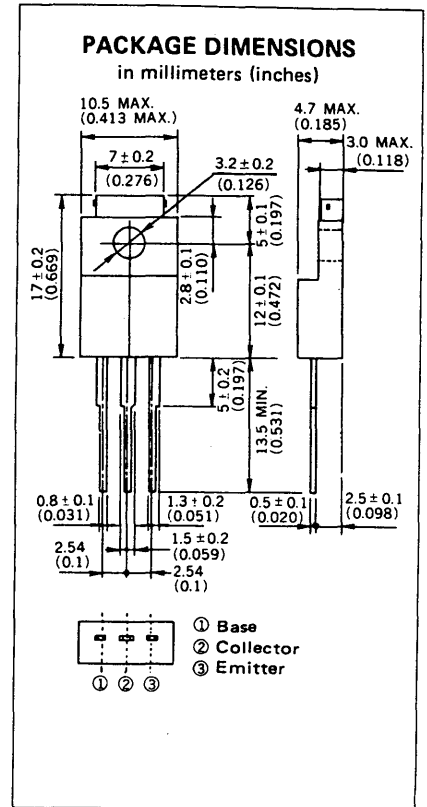

ELECTRICAL CHARACTERISTICS ($T_a = 25^\circ\text{C}$)

SYMBOL	CHARACTERISTIC	MIN.	TYP.	MAX.	UNIT	TEST CONDITIONS
t_{on}	Turn-on Time			1.0	μs	$I_C = 2.0\text{ A}, I_{B1} = -I_{B2} = 0.4\text{ A}$ $R_L = 75\ \Omega, V_{CC} \doteq 150\text{ V}$
t_{stg}	Storage Time			2.0	μs	
t_f	Fall Time			0.7	μs	
h_{FE1}^*	DC Current Gain	20		80	—	$V_{CE} = 5.0\text{ V}, I_C = 0.5\text{ A}$
h_{FE2}^*	DC Current Gain	10			—	$V_{CE} = 5.0\text{ V}, I_C = 2.0\text{ A}$
$V_{CE(sat)}^*$	Collector Saturation Voltage			1.0	V	$I_C = 2.0\text{ A}, I_B = 0.4\text{ A}$
$V_{BE(sat)}^*$	Base Saturation Voltage			1.2	V	$I_C = 2.0\text{ A}, I_B = 0.4\text{ A}$
$V_{CEO(SUS)}$	Collector to Emitter Sustaining Voltage	400			V	$I_C = 2.0\text{ A}, I_B = 0.4\text{ A}, L = 1\text{ mH}$
$V_{CEX(SUS)1}$	Collector to Emitter Sustaining Voltage	450			V	$I_C = 2.0\text{ A}, I_{B1} = -I_{B2} = 0.4\text{ A},$ $L = 180\ \mu\text{H}, \text{Clamped}$
$V_{CEX(SUS)2}$	Collector to Emitter Sustaining Voltage	400			V	$I_C = 4.0\text{ A}, I_{B1} = 0.8\text{ A}, -I_{B2} = 0.4\text{ A},$ $L = 180\ \mu\text{H}, \text{Clamped}$
I_{CBO}	Collector Cutoff Current			10	μA	$V_{CB} = 400\text{ V}, I_E = 0$
I_{CER}	Collector Cutoff Current			1.0	mA	$V_{CE} = 400\text{ V}, R_{BE} = 51\ \Omega, T_a = 125^\circ\text{C}$
I_{CEX1}	Collector Cutoff Current			10	μA	$V_{CE} = 400\text{ V}, V_{BE(OFF)} = -1.5\text{ V}$
I_{CEX2}	Collector Cutoff Current			1.0	mA	$V_{CE} = 400\text{ V}, V_{BE(OFF)} = -1.5\text{ V}, T_a = 125^\circ\text{C}$
I_{EBO}	Emitter Cutoff Current			10	μA	$V_{EB} = 5.0\text{ V}, I_C = 0$

* $PW \leq 350\ \mu\text{s}$, Duty Cycle $\leq 2\%$

Classification of h_{FE1}

Rank	M	L	K
Range	20 to 40	30 to 60	40 to 80

Test Conditions: $V_{CE} = 5.0\text{ V}, I_C = 0.5\text{ A}$

TYPICAL CHARACTERISTICS ($T_a = 25^\circ\text{C}$)

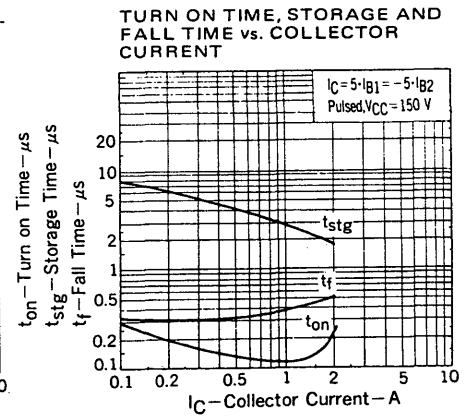
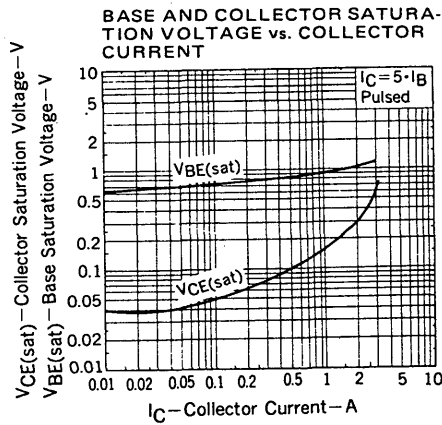
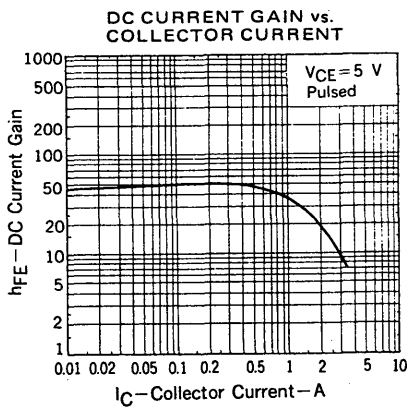
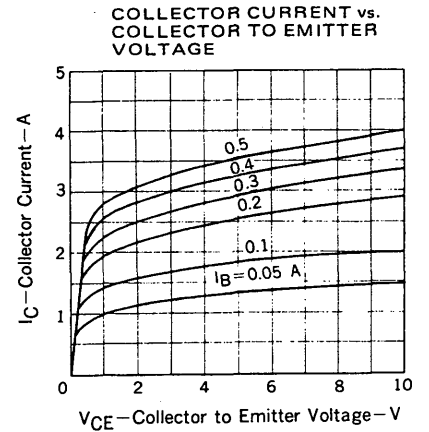
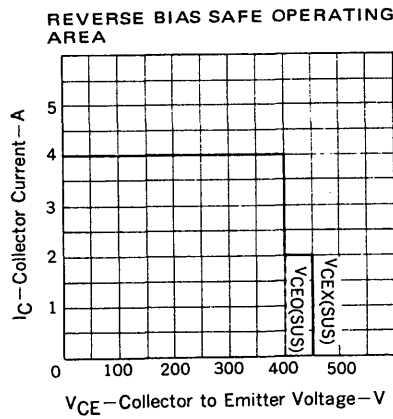
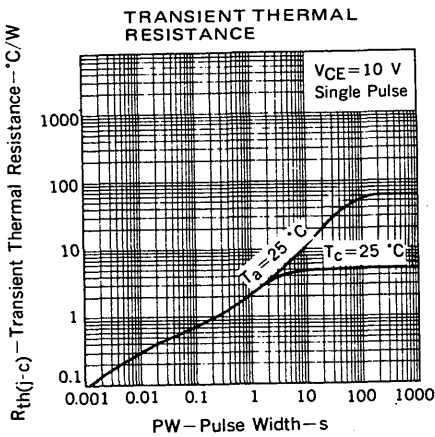
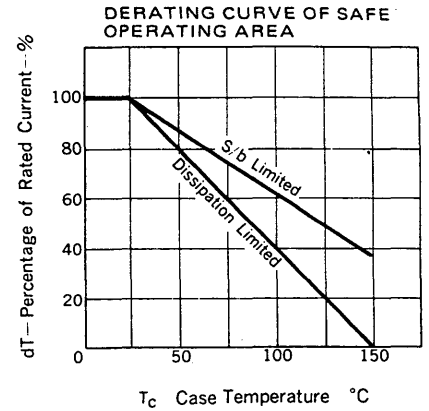
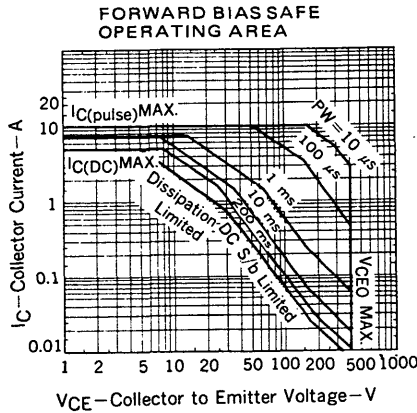
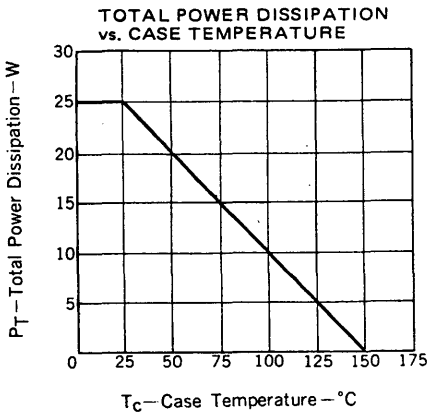

SWITCHING TIME (t_{on} , t_{stg} , t_f) TEST CIRCUIT

