

2SC3795, 2SC3795A

Silicon NPN triple diffusion planar type

For high breakdown voltage high-speed switching

Features

- High-speed switching
- High collector to base voltage V_{CBO}
- Low collector to emitter saturation voltage $V_{CE(sat)}$
- Full-pack package which can be installed to the heat sink with one screw

Absolute Maximum Ratings ($T_C=25^\circ\text{C}$)

Parameter	Symbol	Rated	Unit	
Collector to base voltage	2SC3795	800	V	
	2SC3795A	900		
Collector to emitter voltage	2SC3795	800	V	
	2SC3795A	900		
Collector to emitter voltage	V_{CEO}	500	V	
Emitter to base voltage	V_{EBO}	8	V	
Peak collector current	I_{CP}	10	A	
Collector current	I_C	5	A	
Base current	I_B	3	A	
Collector power dissipation	P_C	$T_C=25^\circ\text{C}$	40	W
		$T_a=25^\circ\text{C}$	2	
Junction temperature	T_j	150	$^\circ\text{C}$	
Storage temperature	T_{stg}	-55 to +150	$^\circ\text{C}$	

Electrical Characteristics ($T_C=25^\circ\text{C}$)

Parameter	Symbol	Conditions	min	typ	max	Unit	
Collector cutoff current	2SC3795	$V_{CB} = 800\text{V}, I_E = 0$			100	μA	
	2SC3795A						
Emitter cutoff current	I_{EBO}	$V_{EB} = 5\text{V}, I_C = 0$			100	μA	
Collector to emitter voltage	$V_{CEO(sus)}^*$	$I_C = 0.2\text{A}, L = 25\text{mH}$	500			V	
Forward current transfer ratio	h_{FE1}	$V_{CE} = 5\text{V}, I_C = 0.1\text{A}$	15				
	h_{FE2}	$V_{CE} = 5\text{V}, I_C = 3\text{A}$	8				
Collector to emitter saturation voltage	$V_{CE(sat)}$	$I_C = 3\text{A}, I_B = 0.6\text{A}$			1	V	
Base to emitter saturation voltage	$V_{BE(sat)}$	$I_C = 3\text{A}, I_B = 0.6\text{A}$			1.5	V	
Transition frequency	f_T	$V_{CE} = 10\text{V}, I_C = 0.5\text{A}, f = 1\text{MHz}$		8		MHz	
Turn-on time	2SC3795	$I_C = 3\text{A}, I_{B1} = 0.6\text{A}, I_{B2} = -0.6\text{A}, V_{CC} = 200\text{V}$			1	μs	
	2SC3795A				1.2		
Storage time	t_{stg}				3		μs
Fall time	2SC3795				1		μs
	2SC3795A	1.2					

* $V_{CEO(sus)}$ Test circuit

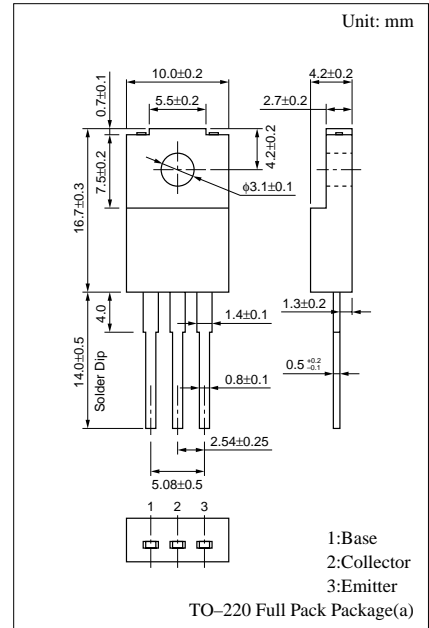
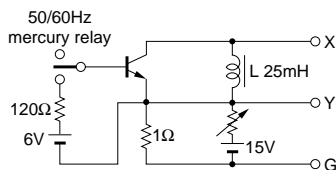

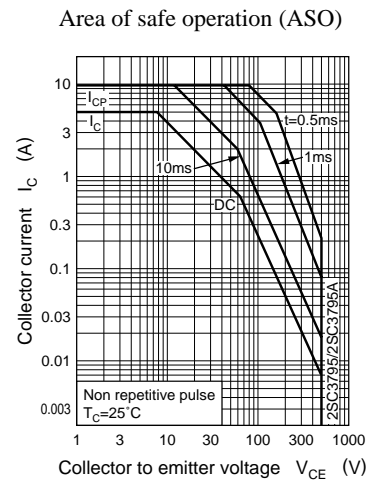
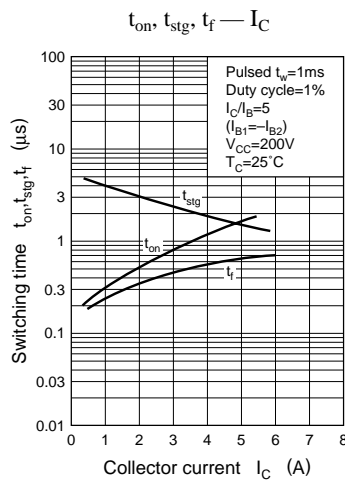
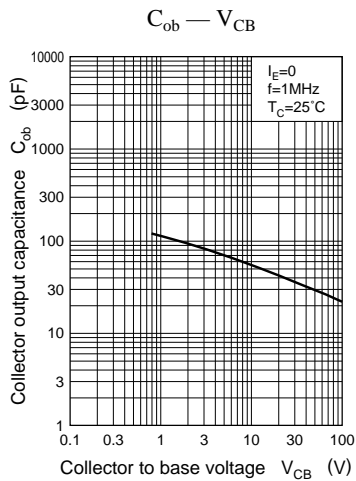
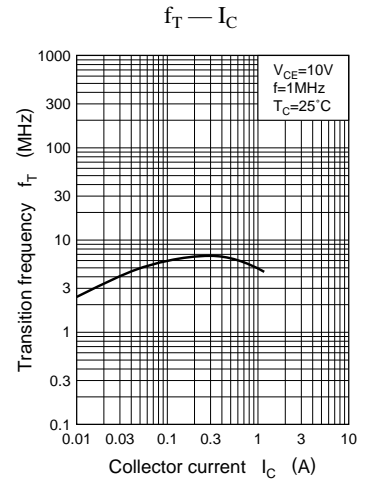
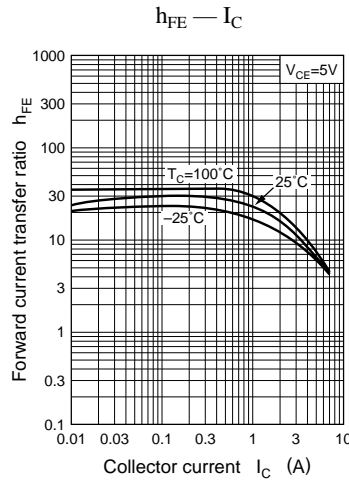
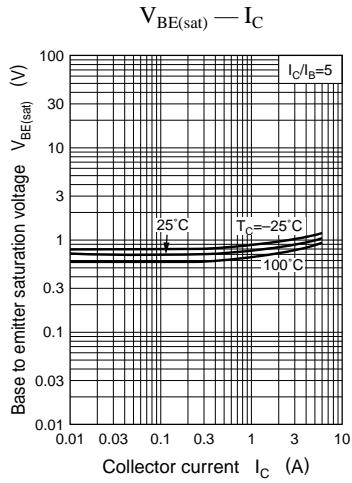
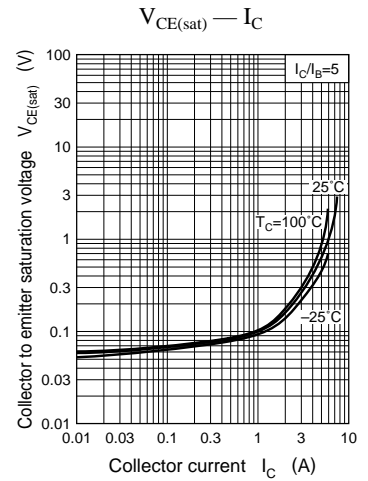
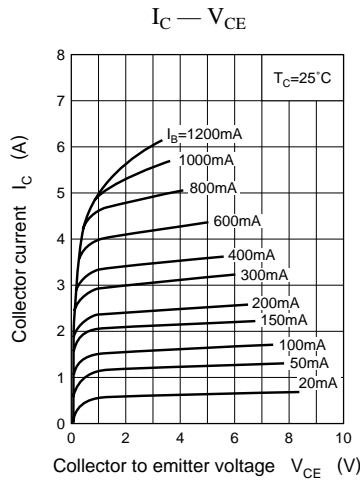
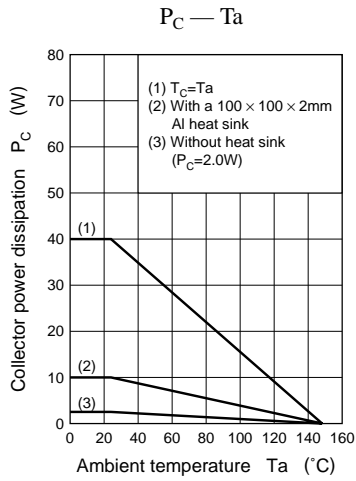

Area of safe operation, reverse bias ASO

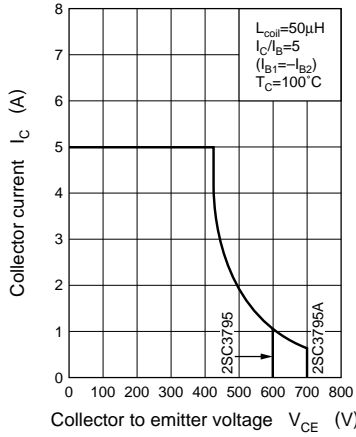

Reverse bias ASO measuring circuit

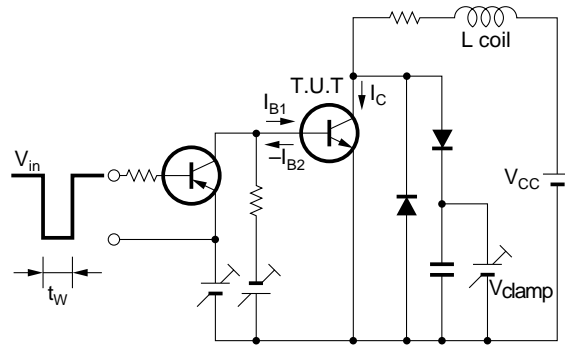

$R_{th(t)} - t$

