

Silicon NPN Power Transistors

2SC3831

DESCRIPTION

- With TO-3PN package
- High voltage
- High speed switching

APPLICATIONS

- For switching regulator and general purpose applications

PINNING

PIN	DESCRIPTION
1	Base
2	Collector;connected to mounting base
3	Emitter

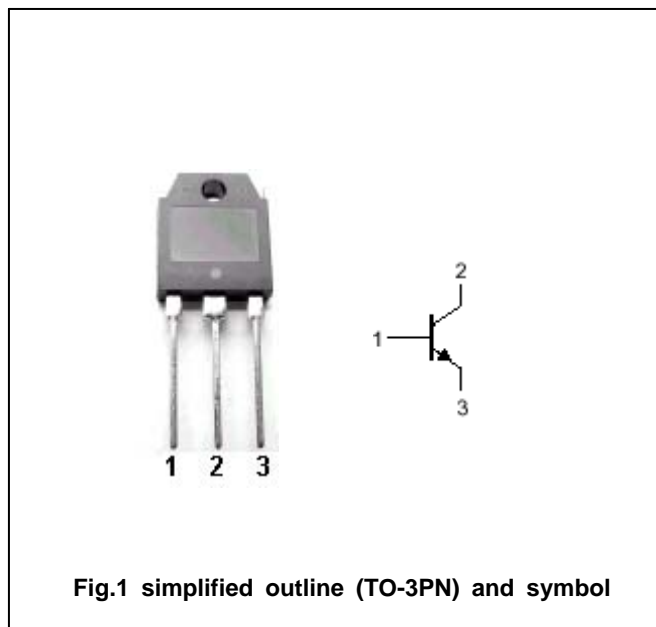
Absolute maximum ratings($T_a = ^\circ\text{C}$)

SYMBOL	PARAMETER	CONDITIONS	VALUE	UNIT
V_{CBO}	Collector-base voltage	Open emitter	600	V
V_{CEO}	Collector-emitter voltage	Open base	500	V
V_{EBO}	Emitter-base voltage	Open collector	10	V
I_C	Collector current		10	A
I_{CP}	Collector current-pulse		20	A
I_B	Base current		4	A
P_C	Collector power dissipation	$T_C = 25^\circ\text{C}$	100	W
T_j	Junction temperature		150	$^\circ\text{C}$
T_{stg}	Storage temperature		-55~150	$^\circ\text{C}$

Silicon NPN Power Transistors

2SC3831

CHARACTERISTICS

T_j=25°C unless otherwise specified

SYMBOL	PARAMETER	CONDITIONS	MIN	TYP.	MAX	UNIT
V _{(BR)CEO}	Collector-emitter breakdown voltage	I _C =25mA; I _B =0	500			V
V _{CEsat}	Collector-emitter saturation voltage	I _C =5A I _B =1.0A			0.5	V
V _{BEsat}	Base-emitter saturation voltage	I _C =5A ;I _B =1.0A			1.3	V
I _{CBO}	Collector cut-off current	V _{CB} =600V; I _E =0			1	mA
I _{EBO}	Emitter cut-off current	V _{EB} =10V; I _C =0			0.1	mA
h _{FE}	DC current gain	I _C =5A ; V _{CE} =4V	10		30	
f _T	Transition frequency	I _C =1A ; V _{CE} =12V		8		MHz
C _{OB}	Output capacitance	f=1MHz ; V _{CB} =10V		105		pF

Switching times

t _{on}	Turn-on time	I _C =5A; V _{CC} =200V I _{B1} =0.5A; I _{B2} =-1A R _L =40 Ω			1.0	μ s
t _{stg}	Storage time				4.5	μ s
t _f	Fall time				0.5	μ s

Silicon NPN Power Transistors

2SC3831

PACKAGE OUTLINE

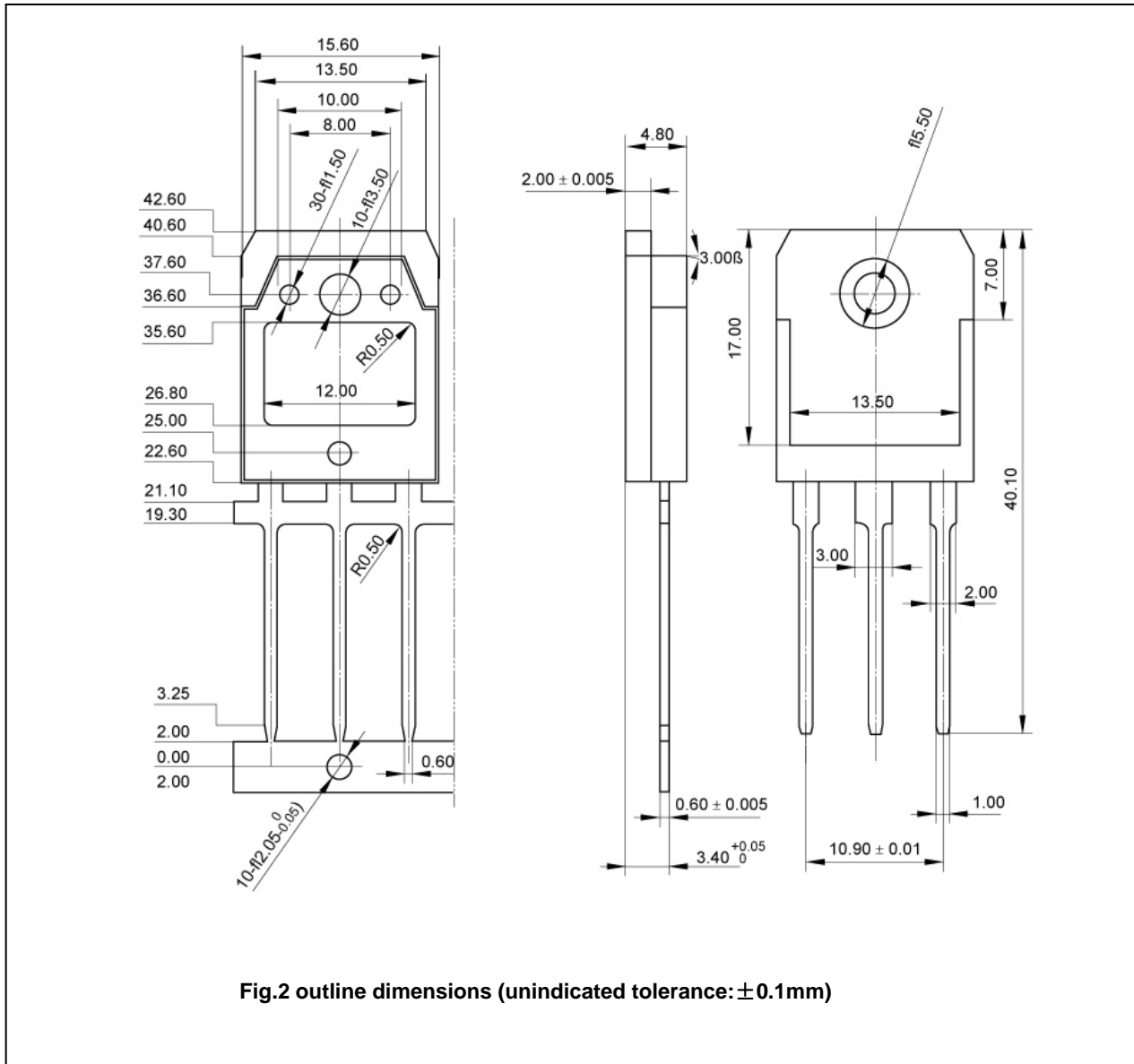

Fig.2 outline dimensions (unindicated tolerance: $\pm 0.1\text{mm}$)

Silicon NPN Power Transistors

2SC3831

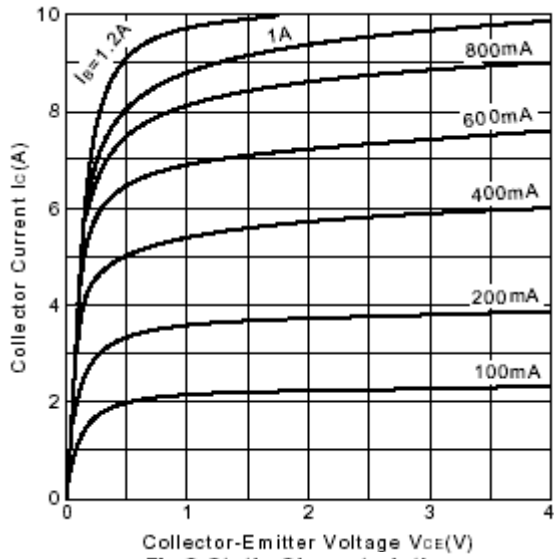

Fig.3 Static Characteristic

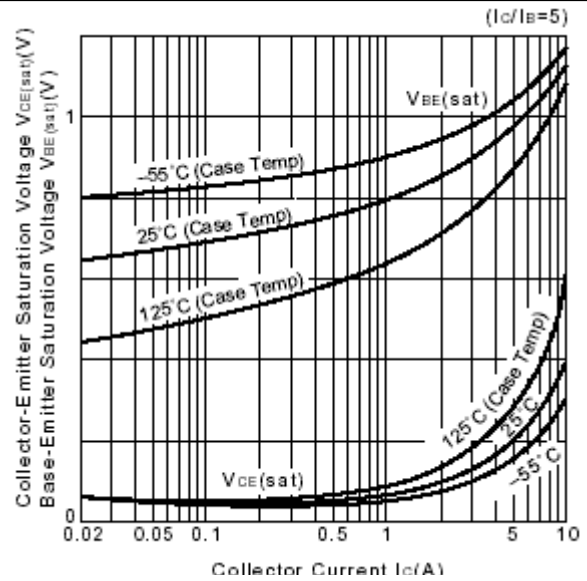

Fig.4 Base-Emitter Saturation Voltage
Collector-Emitter Saturation Voltage

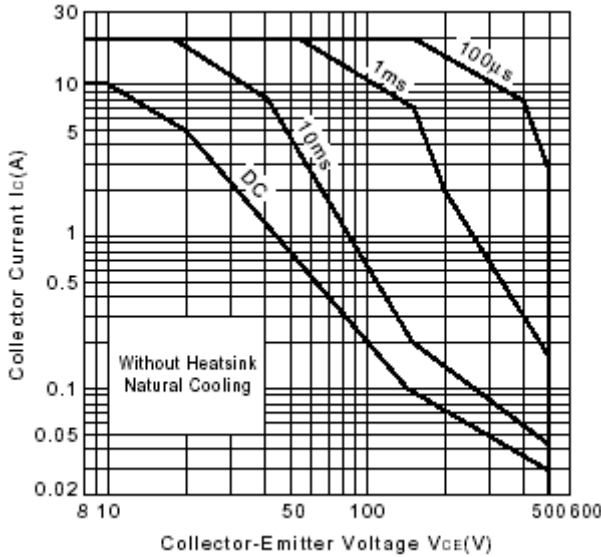

Fig.5 Safe Operating Area

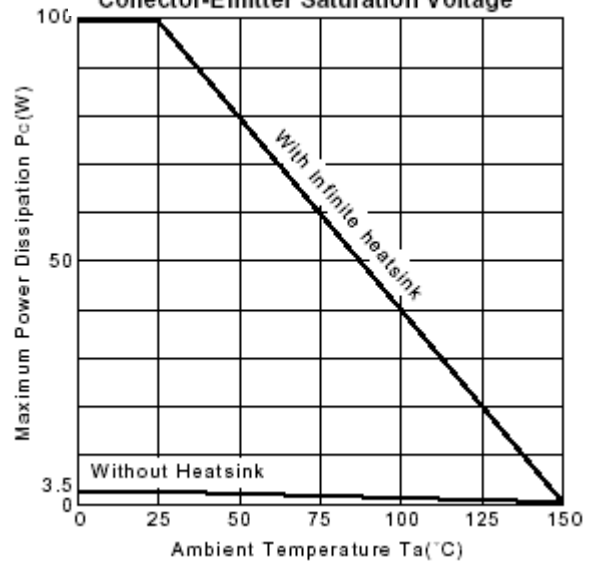

Fig.6 Power Derating

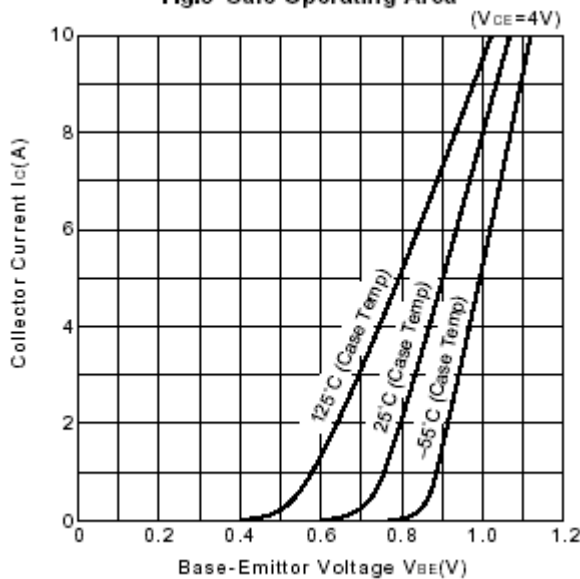

Fig.7 I_c - V_{BE}

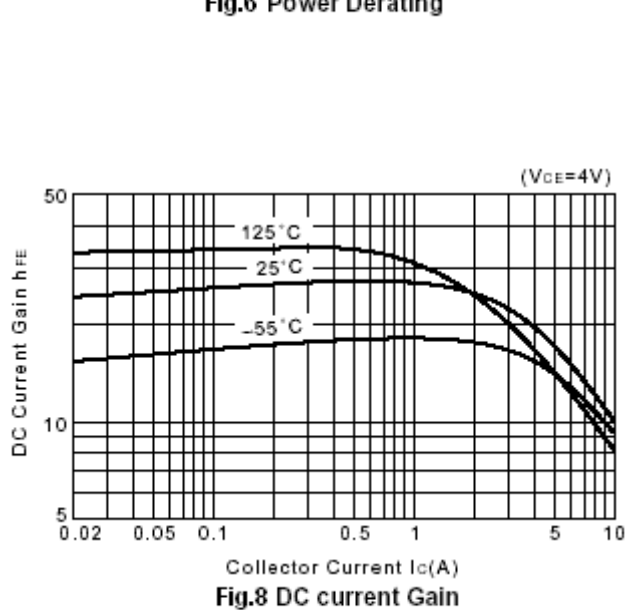

Fig.8 DC current Gain