

Description

- RF amplifier

Features

- High current transition frequency
 $f_T = 550\text{MHz (Typ.)}$, $[V_{CE} = 6\text{V}, I_E = -1\text{mA}]$
- Low output capacitance :
 $C_{ob} = 1.4\text{pF (Typ.)}$ $[V_{CB} = 6\text{V}, I_E = 0]$
- Low base time constant and high gain
- Excellent noise response

Ordering Information

Type NO.	Marking	Package Code
2SC5345	C5345	TO-92

Outline Dimensions

unit : mm

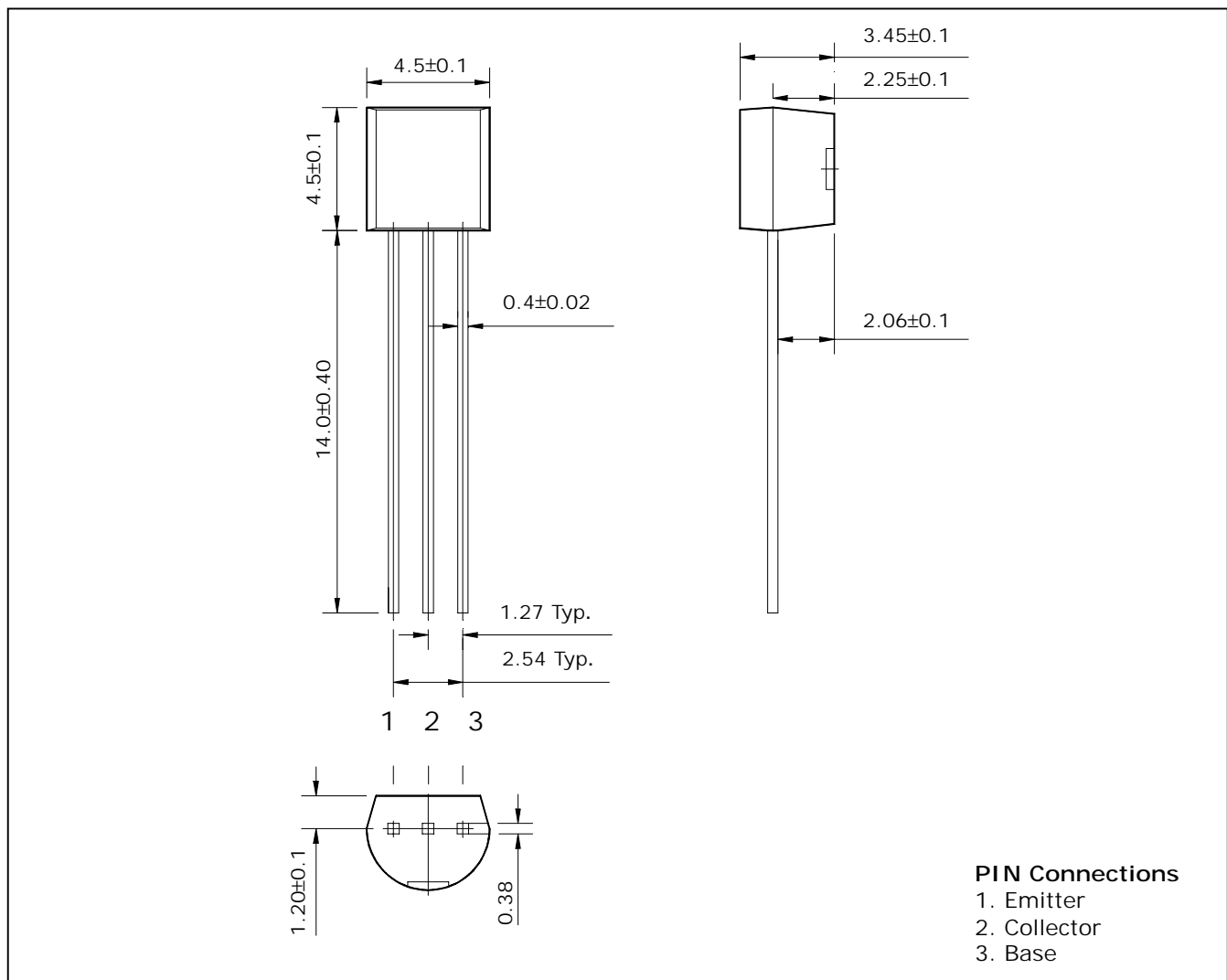

Absolute maximum ratings

Ta=25°C

Characteristic	Symbol	Ratings	Unit
Collector-Base voltage	V_{CBO}	30	V
Collector-Emitter voltage	V_{CEO}	20	V
Emitter-Base voltage	V_{EBO}	4	V
Collector current	I_C	20	mA
Collector dissipation	P_C	625	mW
Junction temperature	T_J	150	°C
Storage temperature range	T_{stg}	-55 ~ 150	°C

Electrical Characteristics

Ta=25°C

Characteristic	Symbol	Test Condition	Min.	Typ.	Max.	Unit
Collector-Base breakdown voltage	BV_{CBO}	$I_C=10\mu A, I_E=0$	30	-	-	V
Collector-Emitter breakdown voltage	BV_{CEO}	$I_C=5mA, I_B=0$	20	-	-	V
Emitter-Base breakdown voltage	BV_{EBO}	$I_E=10\mu A, I_C=0$	4	-	-	V
Collector cut-off current	I_{CBO}	$V_{CB}=30V, I_E=0$	-	-	0.5	μA
Emitter cut-off current	I_{EBO}	$V_{EB}=4V, I_C=0$	-	-	0.5	μA
DC current gain	h_{FE}^*	$V_{CE}=6V, I_C=1mA$	40	-	240	-
Collector-Emitter saturation voltage	$V_{CE(sat)}$	$I_C=10mA, I_B=1mA$	-	-	0.3	V
Transition frequency	f_T	$V_{CE}=6V, I_E=-1mA$	-	550	-	MHz
Collector output capacitance	C_{ob}	$V_{CB}=6V, I_E=0, f=1MHz$	-	1.4	-	pF

* : h_{FE} rank / R : 40~80, O : 70~140, Y : 120~240

Electrical Characteristic Curves

Fig. 1 $P_C - T_a$

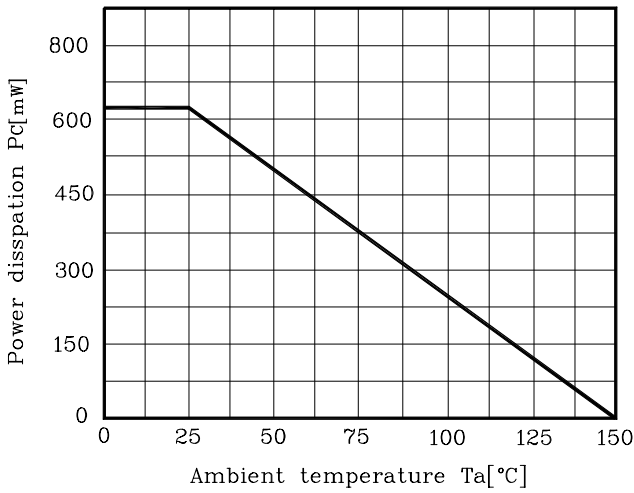

Fig. 2 $I_C - V_{CE}$

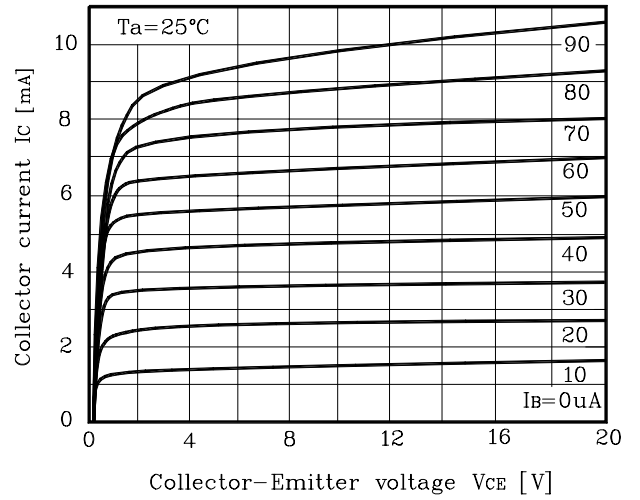

Fig. 3 $h_{FE} - I_C$

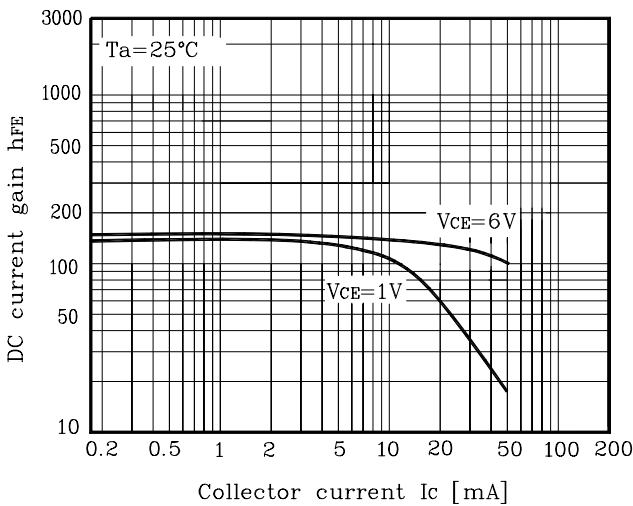

Fig. 4 $f_T - I_E$

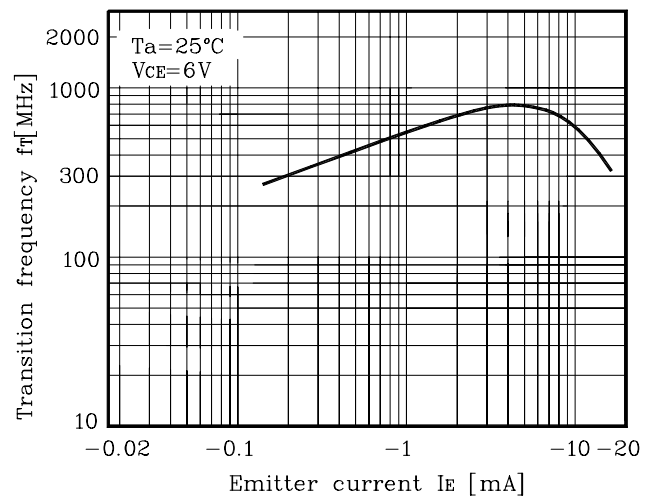

Fig. 5 $C_{ob} - V_{CB}$, $C_{ib} - V_{EB}$

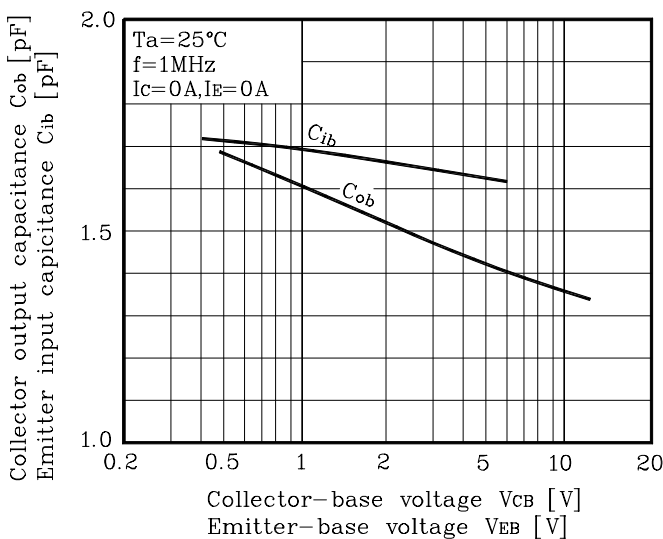
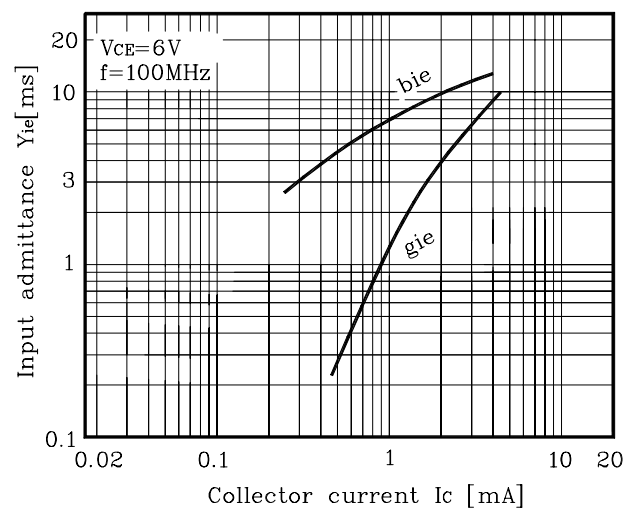

Fig. 6 $Y_{ie} - I_C$



Electrical Characteristic Curves

Fig. 7 I_C - Y_{oe}

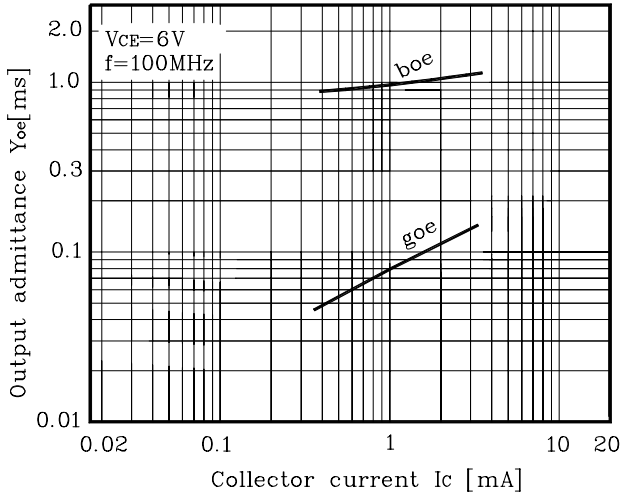

Fig. 8 I_C - Y_{fe}

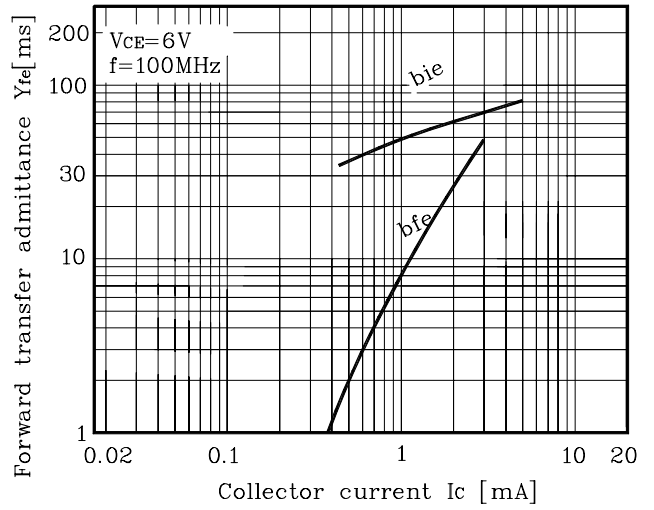

Fig. 9 I_C - Y_{re}

