

---

## *Audio Amplification Transistor*

---

### Features and Benefits

- Small package (TO-3P)
- High power handling capacity, 160 W
- Improved sound output by reduced on-chip impedance
- For professional audio (PA) applications,  $V_{CE0} = 200$  V versions available
- Complementary to 2SA2151
- Recommended output driver: 2SC4832

### Package: 3 Lead TO-3P



### Description

By adapting the SanKen unique wafer-thinner technique, these NPN power transistors achieve power-up by decreasing thermal resistance, and provide higher voltage avalanche breakdown rating. The high power-handling capacity of the TO-3P package allows a smaller footprint on the circuit board design. This series of transistors is very well suited to not only multichannel applications for AV (audio-visual) amplifiers and receivers, but also parallel connection applications for PA (professional audio system) amplifiers.

Applications include the following:

- Single transistors for audio amplifiers
- Home audio amplifiers
- Professional audio amplifiers
- Automobile audio amplifiers
- Audio market
- Single transistors for general purpose

## SELECTION GUIDE

Part Number	Type	$h_{FE}$ Rating	Packing
2SC6011*	NPN	Range O: 50 to 100	Bulk, 100 pieces
		Range P: 70 to 140	
		Range Y: 90 to 180	

\*Specify  $h_{FE}$  range when ordering. If no  $h_{FE}$  range is specified, order will be fulfilled with either or both range O and range Y, depending upon availability.

ABSOLUTE MAXIMUM RATINGS at  $T_A = 25^\circ\text{C}$ 

Characteristic	Symbol	Rating	Unit
Collector-Base Voltage	$V_{CBO}$	200	V
Collector-Emitter Voltage	$V_{CEO}$	200	V
Emitter-Base Voltage	$V_{EBO}$	6	V
Collector Current	$I_C$	15	A
Base Current	$I_B$	4	A
Collector Power Dissipation	$P_C$	160	W
Junction Temperature	$T_J$	150	$^\circ\text{C}$
Storage Temperature	$T_{stg}$	-55 to 150	$^\circ\text{C}$

ELECTRICAL CHARACTERISTICS at  $T_A = 25^\circ\text{C}$ 

Characteristic	Symbol	Test Conditions	Min.	Typ.	Max.	Unit
Collector-Cutoff Current	$I_{CBO}$	$V_{CB} = 200\text{ V}$	–	–	10	$\mu\text{A}$
Emitter Cutoff Current	$I_{EBO}$	$V_{EB} = 6\text{ V}$	–	–	10	$\mu\text{A}$
Collector-Emitter Voltage	$V_{(BR)CEO}$	$I_C = 50\text{ mA}$	200	–	–	V
DC Current Transfer Ratio*	$h_{FE}$	$V_{CE} = 4\text{ V}, I_C = 3\text{ A}$	50	–	180	–
Collector-Emitter Saturation Voltage	$V_{CE(sat)}$	$I_C = 5\text{ A}, I_B = 0.5\text{ A}$	–	–	0.5	V
Cutoff Frequency	$f_T$	$V_{CE} = 12\text{ V}, I_E = -0.5\text{ A}$	–	20	–	MHz
Output Capacitance	$C_{OB}$	$V_{CB} = 10\text{ V}, I_E = 0\text{ A}, f = 1\text{ MHz}$	–	270	–	pF

\* $h_{FE}$  rating: 50 to 100 (O brand on package), 70 to 140 (P), 90 to 180 (Y).

Performance Characteristics

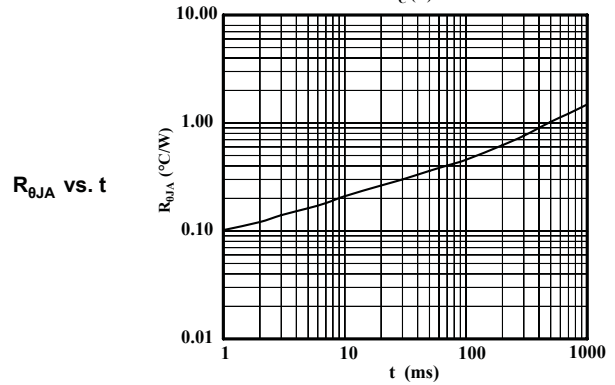
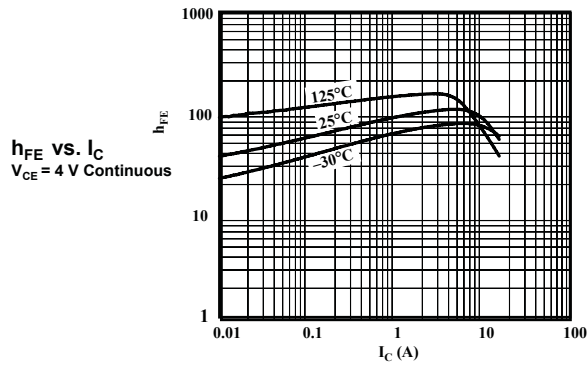
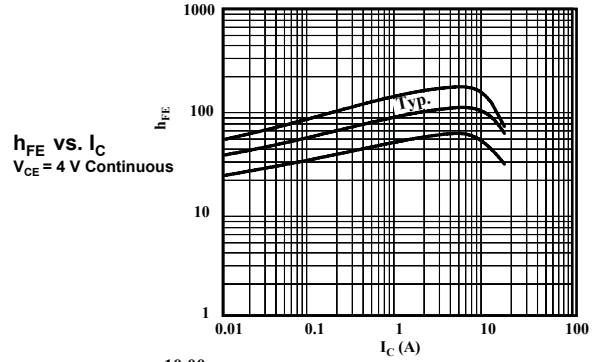
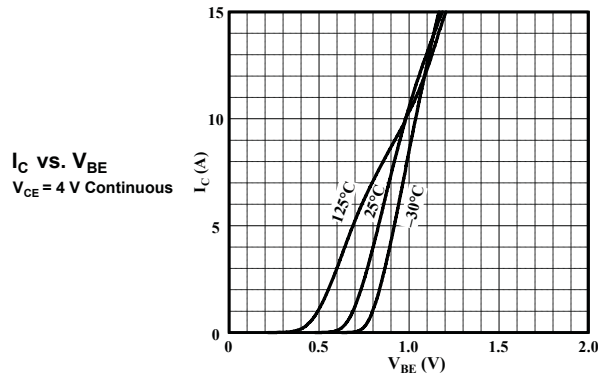
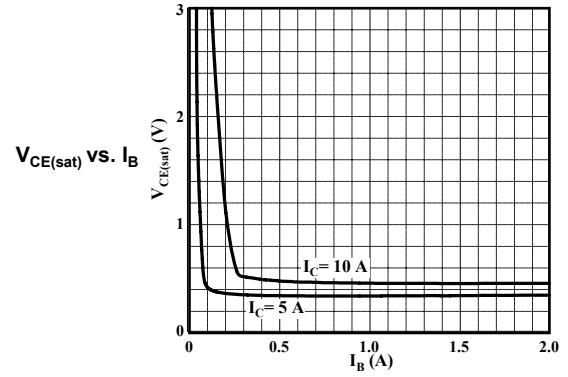
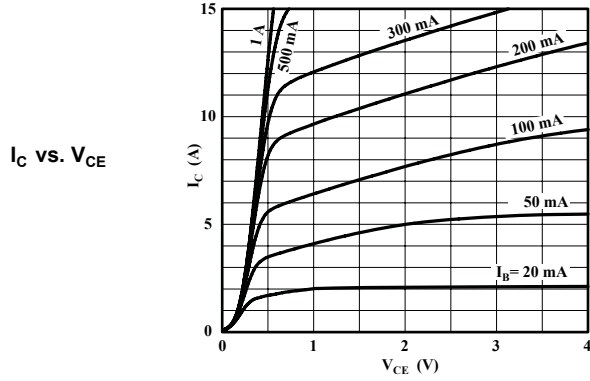

## Performance Characteristics, continued

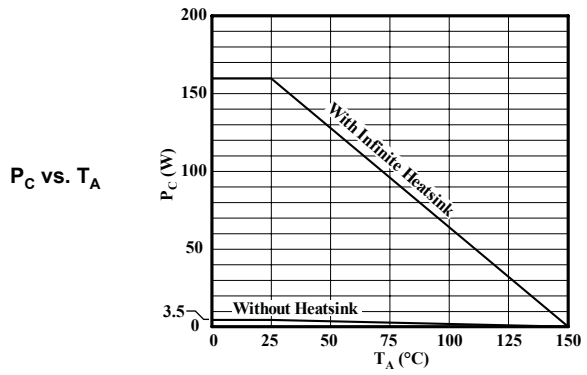
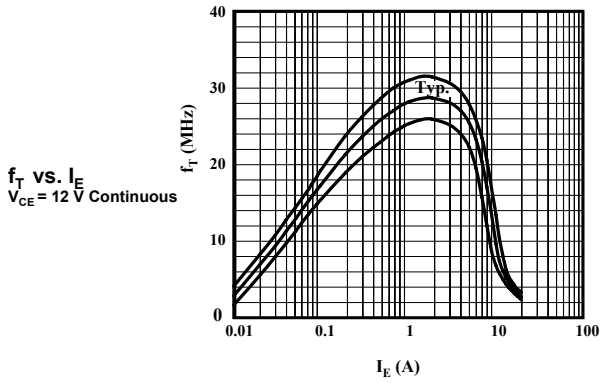
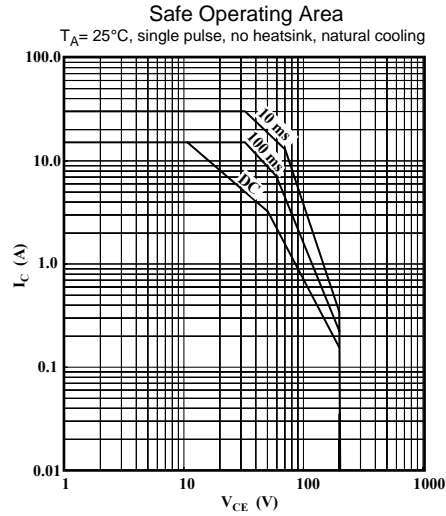

## PACKAGE OUTLINE DRAWING, TO-3P

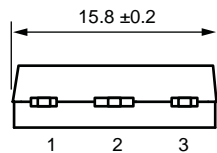
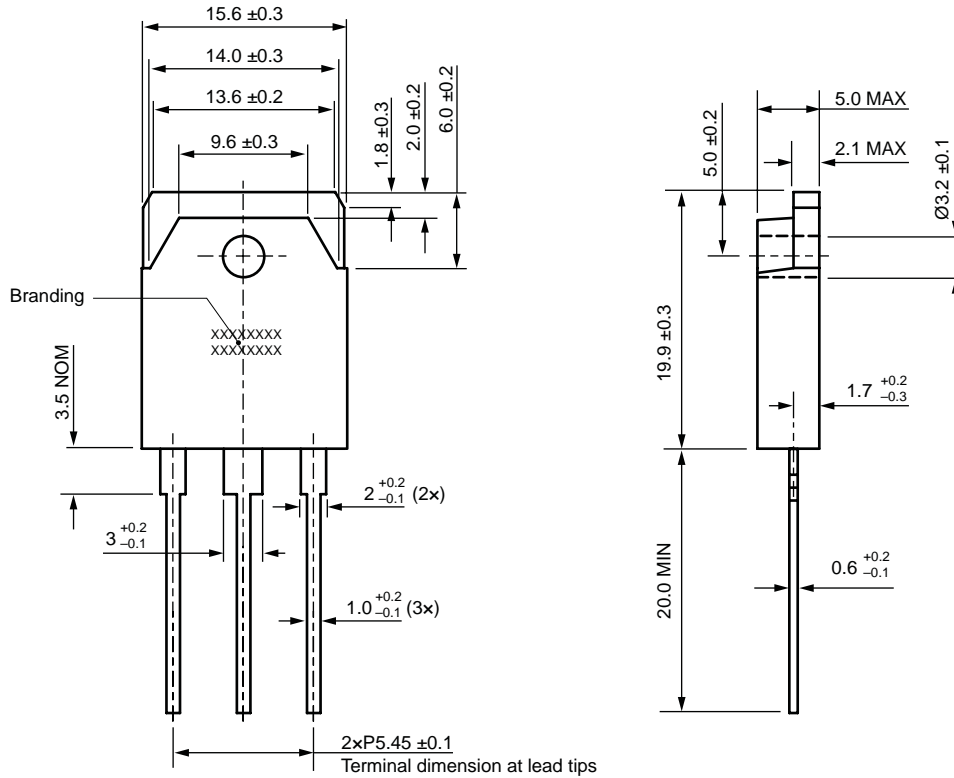

### Pin Assignments:

1. Base
2. Collector
3. Emitter

Terminal core material: Cu  
 Terminal treatment: Ni plating and solder dip  
 Heat sink core material: Cu  
 Heat sink treatment: Ni plating  
 Leadform number: 100

Branding codes (exact appearance at manufacturer discretion):  
 1st line, type: C6011

2nd line, lot: YM H

Where: Y is the last digit of the year of manufacture  
 M is the month (1 to 9, O, N, D)  
 H is the  $h_{FE}$  rating (O, P, or Y; for values see footnote, Electrical Characteristics table)

Dimensions in millimeters



*Leadframe plating Pb-free. Device composition includes high-temperature solder (Pb > 85%), which is exempted from the RoHS directive.*

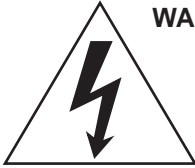

**WARNING** — These devices are designed to be operated at lethal voltages and energy levels. Circuit designs that embody these components must conform with applicable safety requirements. Precautions must be taken to prevent accidental contact with power-line potentials. Do not connect grounded test equipment.

The use of an isolation transformer is recommended during circuit development and breadboarding.

Because reliability can be affected adversely by improper storage environments and handling methods, please observe the following cautions.

#### Cautions for Storage

- Ensure that storage conditions comply with the standard temperature (5°C to 35°C) and the standard relative humidity (around 40 to 75%); avoid storage locations that experience extreme changes in temperature or humidity.
- Avoid locations where dust or harmful gases are present and avoid direct sunlight.
- Reinspect for rust on leads and solderability of products that have been stored for a long time.

#### Cautions for Testing and Handling

When tests are carried out during inspection testing and other standard test periods, protect the products from power surges from the testing device, shorts between adjacent products, and shorts to the heatsink.

#### Remarks About Using Silicone Grease with a Heatsink

- When silicone grease is used in mounting this product on a heatsink, it shall be applied evenly and thinly. If more silicone grease than required is applied, it may produce stress.
- Coat the back surface of the product and both surfaces of the insulating plate to improve heat transfer between the product and the heatsink.
- Volatile-type silicone greases may permeate the product and produce cracks after long periods of time, resulting in reduced heat radiation effect, and possibly shortening the lifetime of the product.
- Our recommended silicone greases for heat radiation purposes, which will not cause any adverse effect on the product life, are indicated below:

Type	Suppliers
G746	Shin-Etsu Chemical Co., Ltd.
YG6260	GE Toshiba Silicone Co., Ltd.
SC102	Dow Corning Toray Silicone Co., Ltd.

#### Heatsink Mounting Method

- **Torque When Tightening Mounting Screws.** Thermal resistance increases when tightening torque is low, and radiation effects are decreased. When the torque is too high, the screw can strip, the heatsink can be deformed, and distortion can arise in the product frame. To avoid these problems, observe the recommended tightening torques for this product package type, TO-3P (MT-100): 0.686 to 0.882 N•m (7 to 9 kgf•cm).
- **Diameter of Heatsink Hole:** < 4 mm. The deflection of the press mold when making the hole may cause the case material to crack at the joint with the heatsink. Please pay special attention for this effect.

#### Soldering

- When soldering the products, please be sure to minimize the working time, within the following limits:  
 260±5°C 10 s  
 350±5°C 3 s
- Soldering iron should be at a distance of at least 1.5 mm from the body of the products

#### Electrostatic Discharge

- When handling the products, operator must be grounded. Grounded wrist straps worn should have at least 1 MΩ of resistance to ground to prevent shock hazard.
- Workbenches where the products are handled should be grounded and be provided with conductive table and floor mats.
- When using measuring equipment such as a curve tracer, the equipment should be grounded.
- When soldering the products, the head of soldering irons or the solder bath must be grounded in order to prevent leak voltages generated by them from being applied to the products.
- The products should always be stored and transported in our shipping containers or conductive containers, or be wrapped in aluminum foil.

*The products described herein are manufactured in Japan by Sanken Electric Co., Ltd. for sale by Allegro MicroSystems, Inc.*

*Sanken and Allegro reserve the right to make, from time to time, such departures from the detail specifications as may be required to permit improvements in the performance, reliability, or manufacturability of its products. Therefore, the user is cautioned to verify that the information in this publication is current before placing any order.*

*When using the products described herein, the applicability and suitability of such products for the intended purpose shall be reviewed at the users responsibility.*

*Although Sanken undertakes to enhance the quality and reliability of its products, the occurrence of failure and defect of semiconductor products at a certain rate is inevitable.*

*Users of Sanken products are requested to take, at their own risk, preventative measures including safety design of the equipment or systems against any possible injury, death, fires or damages to society due to device failure or malfunction.*

*Sanken products listed in this publication are designed and intended for use as components in general-purpose electronic equipment or apparatus (home appliances, office equipment, telecommunication equipment, measuring equipment, etc.). Their use in any application requiring radiation hardness assurance (e.g., aerospace equipment) is not supported.*

*When considering the use of Sanken products in applications where higher reliability is required (transportation equipment and its control systems or equipment, fire- or burglar-alarm systems, various safety devices, etc.), contact a company sales representative to discuss and obtain written confirmation of your specifications.*

*The use of Sanken products without the written consent of Sanken in applications where extremely high reliability is required (aerospace equipment, nuclear power-control stations, life-support systems, etc.) is strictly prohibited.*

*The information included herein is believed to be accurate and reliable. Application and operation examples described in this publication are given for reference only and Sanken and Allegro assume no responsibility for any infringement of industrial property rights, intellectual property rights, or any other rights of Sanken or Allegro or any third party that may result from its use.*

*Anti radioactive ray design is not considered for the products listed herein.*