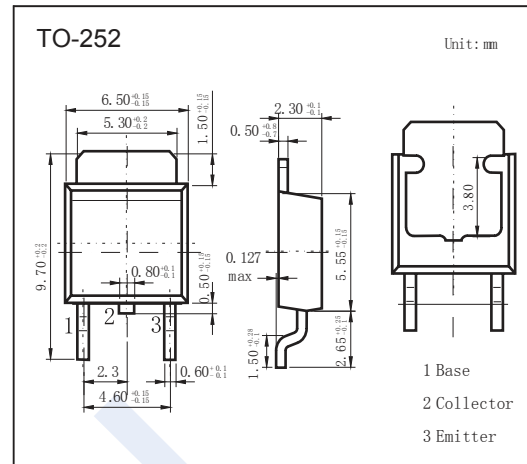

NPN Transistors

2SD1254

■ Features

- High forward current transfer ratio h_{FE} which has satisfactory linearity
- Low collector to emitter saturation voltage $V_{CE(sat)}$
- Large collector current I_c
- Complementary to 2SB931

■ Absolute Maximum Ratings $T_a = 25^\circ\text{C}$

Parameter	Symbol	Rating	Unit	
Collector - Base Voltage	V_{CBO}	130	V	
Collector - Emitter Voltage	V_{CEO}	80		
Emitter - Base Voltage	V_{EBO}	7		
Collector Current - Continuous	I_c	3	A	
Collector Current - Pulse	I_{CP}	6		
Collector Power Dissipation	P_c	$T_c = 25^\circ\text{C}$	30	W
		$T_a = 25^\circ\text{C}$	1.3	
Junction Temperature	T_J	150	$^\circ\text{C}$	
Storage Temperature Range	T_{stg}	-55 to 150		

■ Electrical Characteristics $T_a = 25^\circ\text{C}$

Parameter	Symbol	Test Conditions	Min	Typ	Max	Unit
Collector- base breakdown voltage	V_{CBO}	$I_c = 100 \mu\text{A}$, $I_E = 0$	130			V
Collector- emitter breakdown voltage	V_{CEO}	$I_c = 10 \text{ mA}$, $I_B = 0$	80			
Emitter - base breakdown voltage	V_{EBO}	$I_E = 100 \mu\text{A}$, $I_c = 0$	7			
Collector-base cut-off current	I_{CBO}	$V_{CB} = 100 \text{ V}$, $I_E = 0$			10	μA
Emitter cut-off current	I_{EBO}	$V_{EB} = 5 \text{ V}$, $I_c = 0$			50	
Collector-emitter saturation voltage	$V_{CE(sat)}$	$I_c = 2 \text{ A}$, $I_B = 100 \text{ mA}$			0.5	V
Base - emitter saturation voltage	$V_{BE(sat)}$	$I_c = 2 \text{ A}$, $I_B = 100 \text{ mA}$			1.5	
DC current gain	$h_{FE(1)}$	$V_{CE} = 2 \text{ V}$, $I_c = 100 \text{ mA}$	45			
	$h_{FE(2)}$	$V_{CE} = 2 \text{ V}$, $I_c = 500 \text{ mA}$	60		260	
Turn-on time	t_{on}	$I_c = 0.5 \text{ A}$, $I_{B1} = 50 \text{ mA}$, $I_{B2} = -50 \text{ mA}$, $V_{CC} = 50 \text{ V}$		0.5		μs
Storage time	t_{stg}			2.5		
Fall time	t_f			0.15		
Transition frequency	f_T	$V_{CE} = 10 \text{ V}$, $I_c = 500 \text{ mA}$, $f = 10 \text{ MHz}$		30		MHz

■ Classification of $h_{FE(2)}$

Type	2SD1254-R	2SD1254-Q	2SD1254-P
Range	60-120	90-180	130-260

NPN Transistors

2SD1254

Typical Characteristics

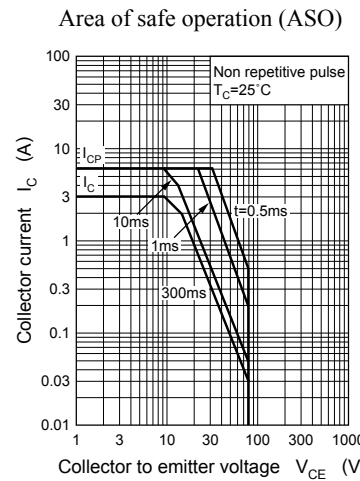
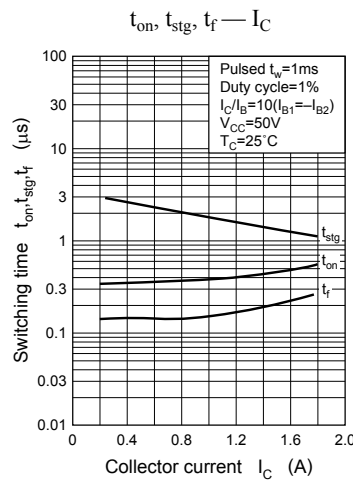
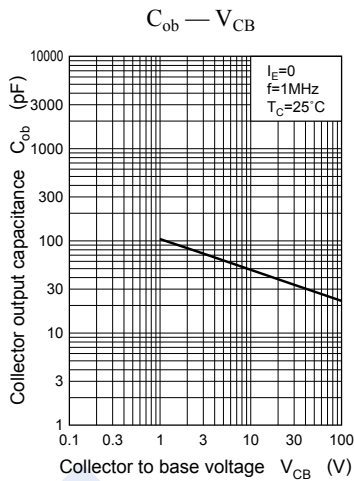
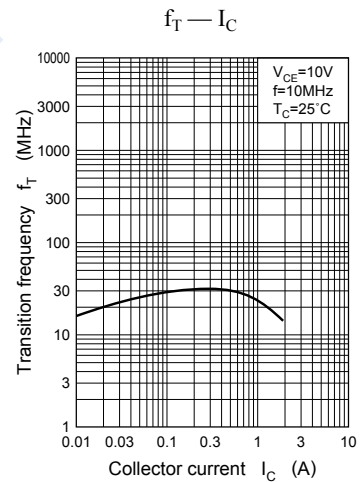
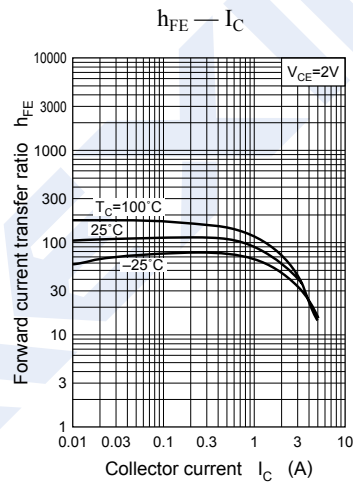
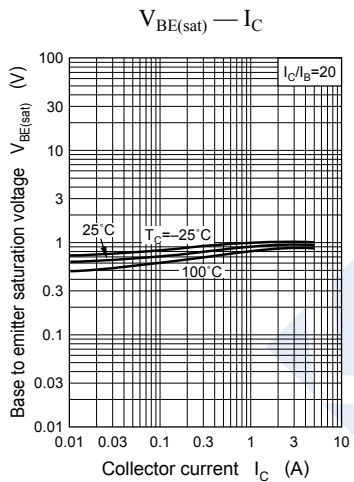
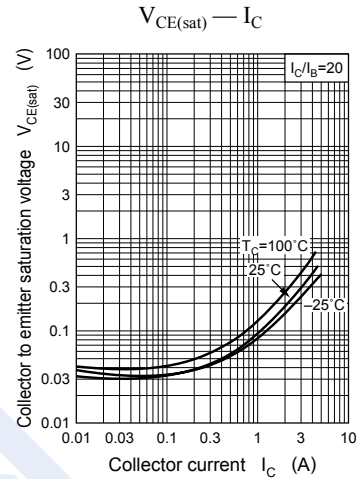
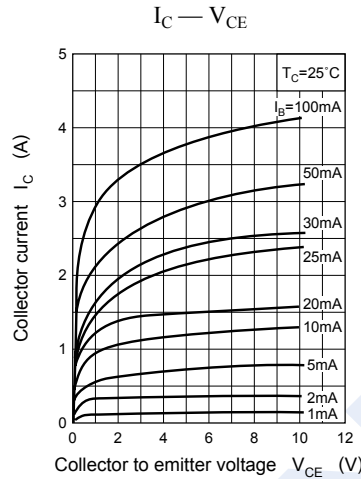
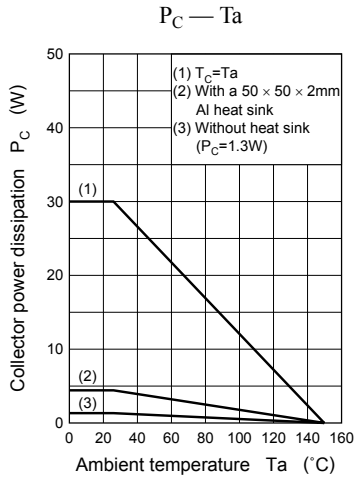

NPN Transistors

2SD1254

■ Typical Characteristics

