

## NPN Transistors

### 2SD1257A

#### ■ Features

- Satisfactory linearity of forward current transfer ratio  $h_{FE}$
- Low collector to emitter saturation voltage  $V_{CE(sat)}$
- Large collector current  $I_C$

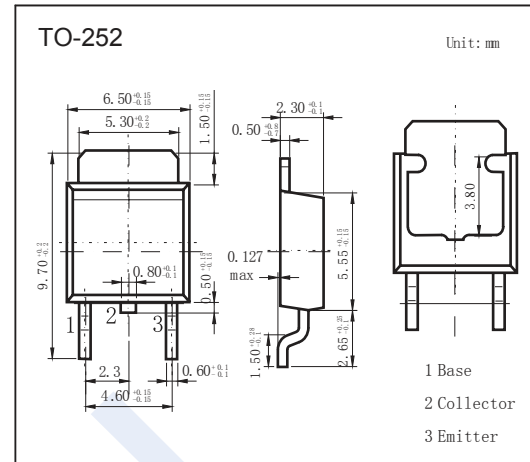

#### ■ Absolute Maximum Ratings $T_a = 25^\circ\text{C}$

Parameter	Symbol	Rating	Unit	
Collector - Base Voltage	$V_{CBO}$	150	V	
Collector - Emitter Voltage	$V_{CEO}$	100		
Emitter - Base Voltage	$V_{EBO}$	7		
Collector Current - Continuous	$I_C$	7	A	
Collector Current - Pulse	$I_{CP}$	15		
Collector Power Dissipation	$P_C$	$T_c = 25^\circ\text{C}$	40	W
		$T_a = 25^\circ\text{C}$	1.3	
Junction Temperature	$T_J$	150	$^\circ\text{C}$	
Storage Temperature Range	$T_{stg}$	-55 to 150		

#### ■ Electrical Characteristics $T_a = 25^\circ\text{C}$

Parameter	Symbol	Test Conditions	Min	Typ	Max	Unit
Collector-base breakdown voltage	$V_{CBO}$	$I_C = 100 \mu\text{A}$ , $I_E = 0$	150			V
Collector-emitter breakdown voltage	$V_{CEO}$	$I_C = 10 \text{ mA}$ , $I_B = 0$	100			
Emitter - base breakdown voltage	$V_{EBO}$	$I_E = 100 \mu\text{A}$ , $I_C = 0$	7			
Collector-base cut-off current	$I_{CBO}$	$V_{CB} = 120 \text{ V}$ , $I_E = 0$			10	$\mu\text{A}$
Emitter cut-off current	$I_{EBO}$	$V_{EB} = 5 \text{ V}$ , $I_C = 0$			50	
Collector-emitter saturation voltage	$V_{CE(sat)}$	$I_C = 5 \text{ A}$ , $I_B = 250 \text{ mA}$			0.5	V
Base - emitter saturation voltage	$V_{BE(sat)}$	$I_C = 5 \text{ A}$ , $I_B = 250 \text{ mA}$			1.5	
DC current gain	$h_{FE(1)}$	$V_{CE} = 2 \text{ V}$ , $I_C = 100 \text{ mA}$	45			
	$h_{FE(2)}$	$V_{CE} = 2 \text{ V}$ , $I_C = 3 \text{ A}$	60		260	
Turn-on time	$t_{on}$	$I_C = 3 \text{ A}$ , $I_{B1} = 300 \text{ mA}$ , $I_{B2} = -300 \text{ mA}$ , $V_{CC} = 50 \text{ V}$		0.5		$\mu\text{s}$
Storage time	$t_{stg}$			1.5		
Fall time	$t_f$			0.1		
Transition frequency	$f_T$	$V_{CE} = 10 \text{ V}$ , $I_C = 500 \text{ mA}$ , $f = 10 \text{ MHz}$		30		MHz

#### ■ Classification of $h_{FE(2)}$

Type	2SD1257A-R	2SD1257A-Q	2SD1257A-P
Range	60-120	90-180	130-260

# NPN Transistors

## 2SD1257A

■ Typical Characteristics

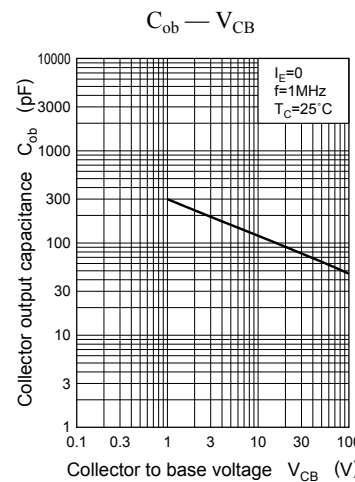
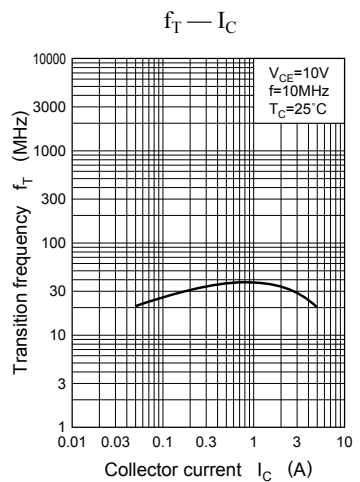
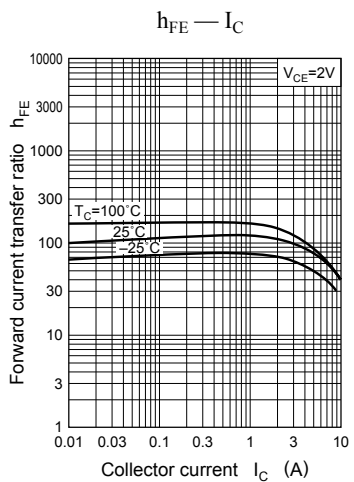
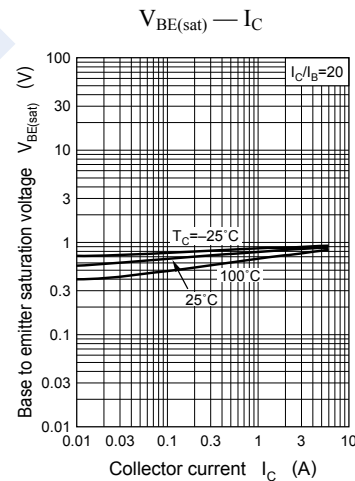
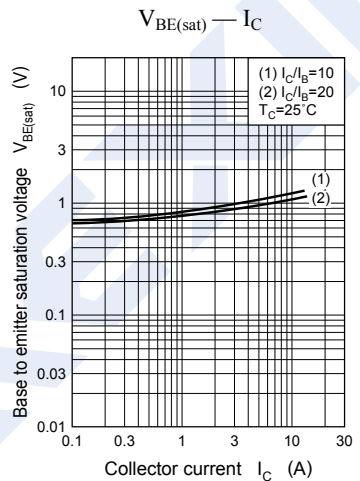
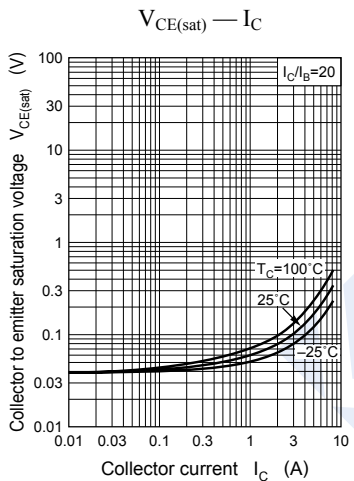
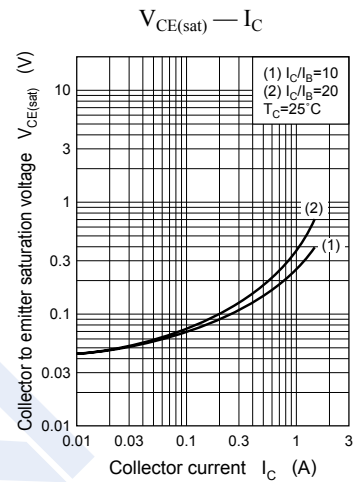
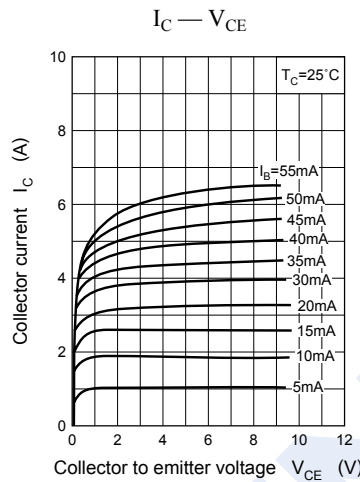
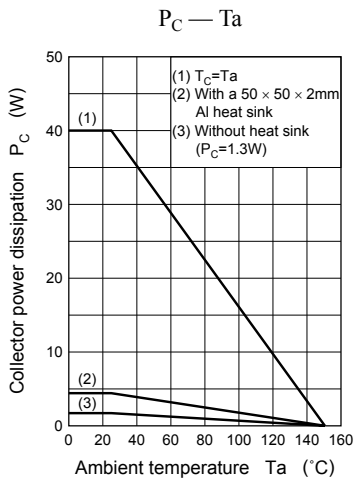

## NPN Transistors 2SD1257A

■ Typical Characteristics

