

SHINDENGEN

Darlington Transistor

2SD1789
(TP4L20)

± 4A NPN

OUTLINE DIMENSIONS

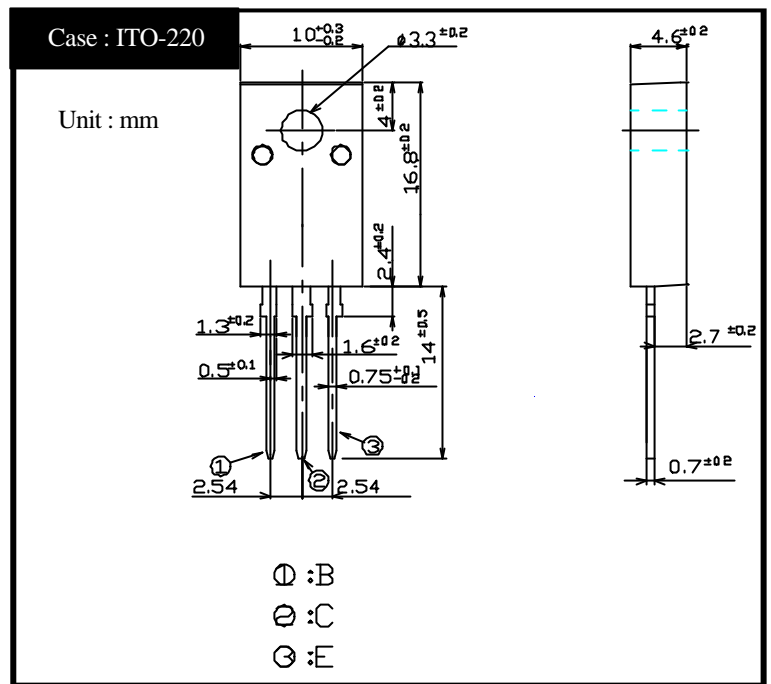

RATINGS

Absolute Maximum Ratings

| Item | Symbol | Conditions | Ratings | Unit |
|------------------------------|------------------|--------------------------------|------------|------|
| Storage Temperature | T _{stg} | | -55 ~ +150 | |
| Junction Temperature | T _j | | +150 | |
| Collector to Base Voltage | V _{CB0} | | 200 | V |
| Collector to Emitter Voltage | V _{CEO} | | 200 | V |
| Emitter to Base Voltage | V _{EBO} | | 7 | V |
| Collector Current DC | I _C | | ± 4 | A |
| Collector Current Peak | I _{CP} | | ± 6 | A |
| Base Current DC | I _B | | 0.3 | A |
| Base Current Peak | I _{BP} | | 0.5 | A |
| Total Transistor Dissipation | P _T | T _C = 25 | 25 | W |
| Dielectric Strength | V _{dis} | Terminals to case AC 1 minute | 2 | kV |
| Mounting Torque | TOR | (Recommended torque : 0.3N·m) | 0.5 | N·m |

Electrical Characteristics (T_c=25)

| Item | Symbol | Conditions | Ratings | Unit |
|---|----------------------|--|------------|------|
| Collector Cutoff Current | I _{CBO} | V _{CB} = 200V | Max 0.1 | mA |
| | I _{CEO} | V _{CE} = 200V | Max 0.1 | |
| Emitter Cutoff Current | I _{EBO} | V _{EB} = 7V | Max 5 | mA |
| DC Current Gain | h _{FE} | V _{CE} = 3V, I _C = 1A | Min 1,500 | |
| | | | Max 30,000 | |
| Collector to Emitter Saturation Voltage | V _{CE(sat)} | I _C = 1A | Max 1.5 | V |
| Base to Emitter Saturation Voltage | V _{BE(sat)} | I _B = 2mA | Max 2.0 | V |
| Thermal Resistance | θ _{JC} | Junction to case | Max 5.0 | /W |
| Transition Frequency | f _T | V _{CE} = 10V, I _C = 0.4A | TYP 20 | MHz |
| Turn on Time | t _{on} | I _C = 1A I _{B1} = I _{B2} = 2mA R _L = 25 V _{BB2} = 4V | Max 2 | μs |
| Storage Time | t _s | | Max 12 | |
| Fall Time | t _f | | Max 5 | |

2SD1789

$h_{FE} - I_C$

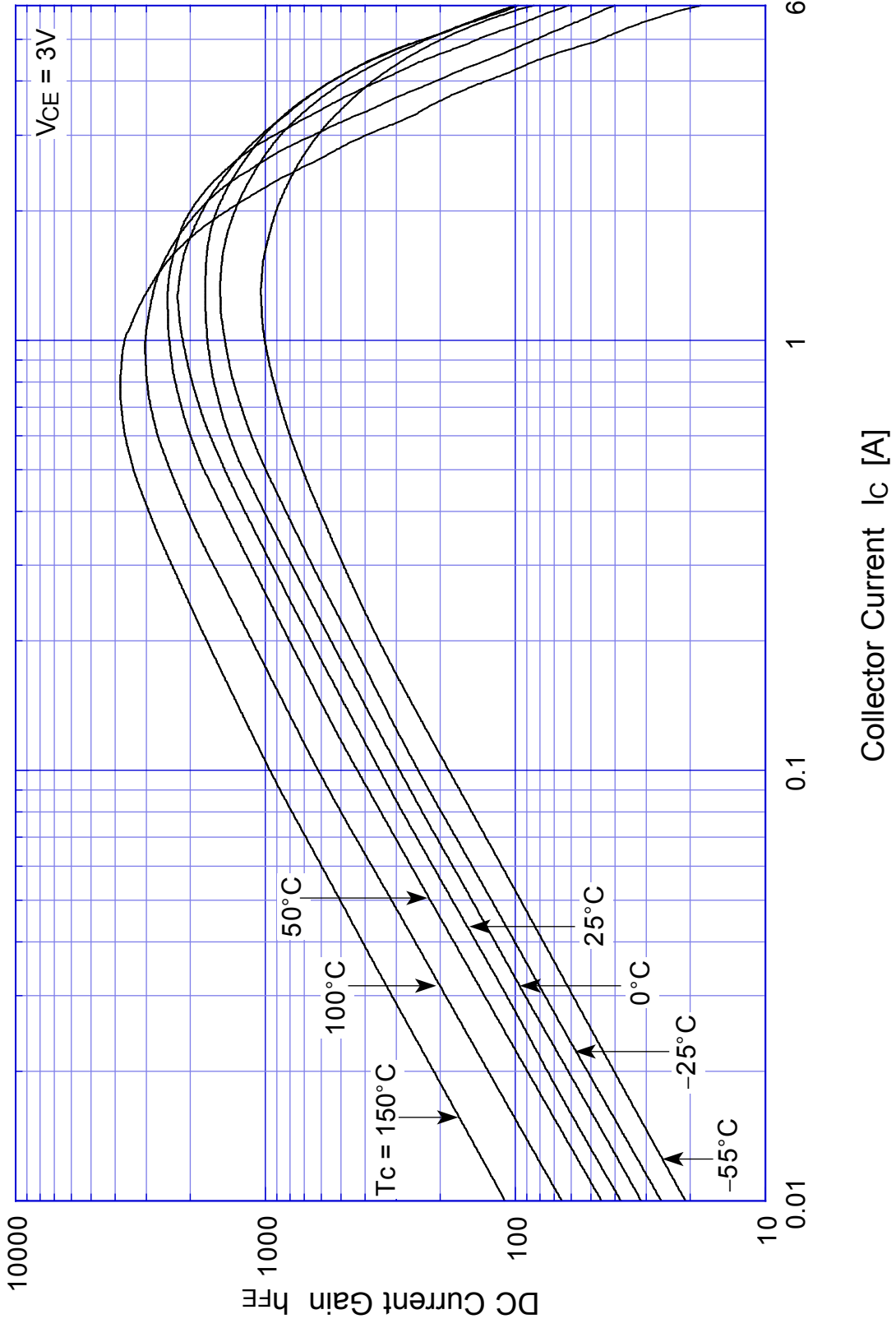

2SD1789 Saturation Voltage

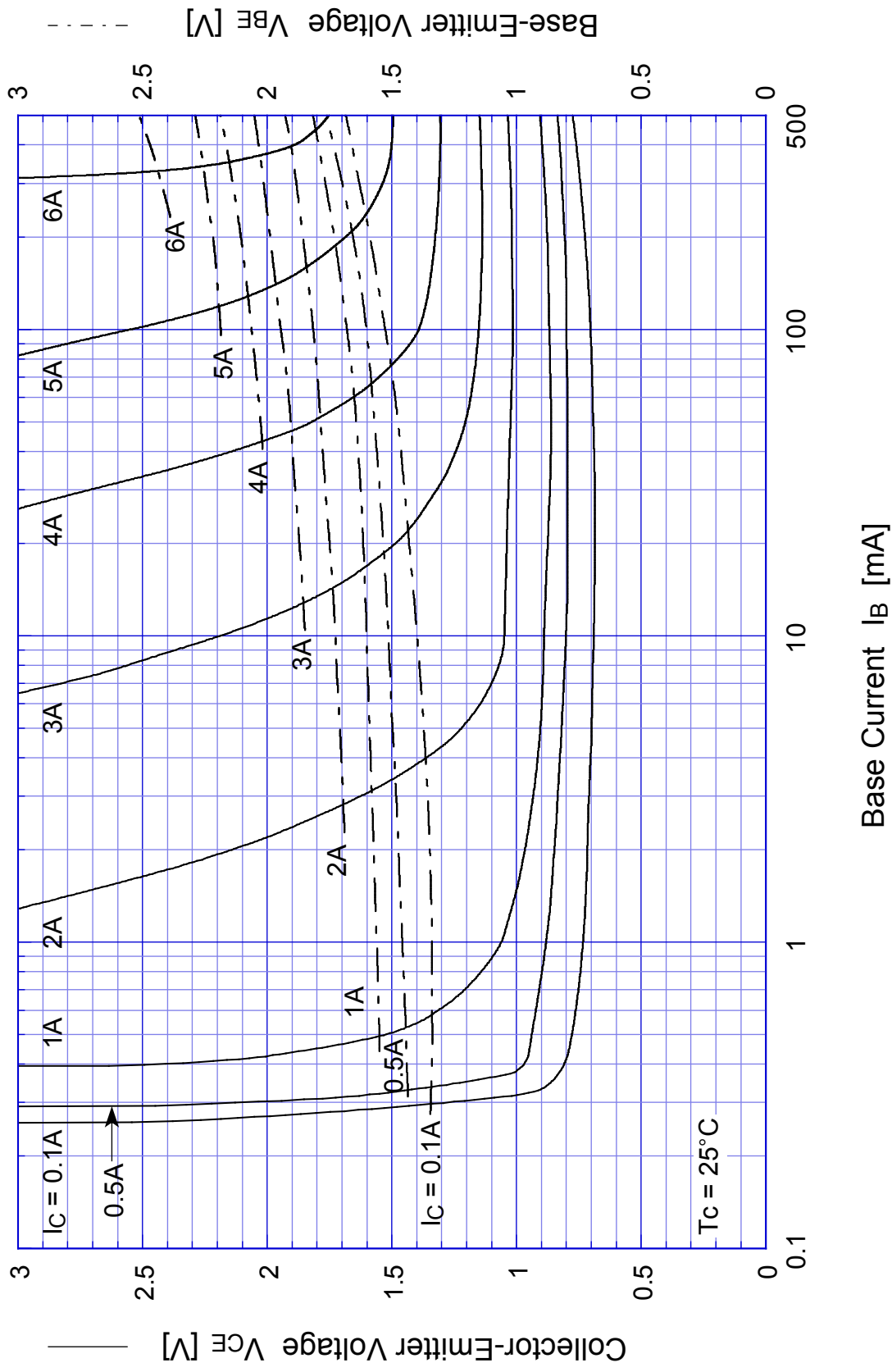

2SD1789

Switching Time - I_C

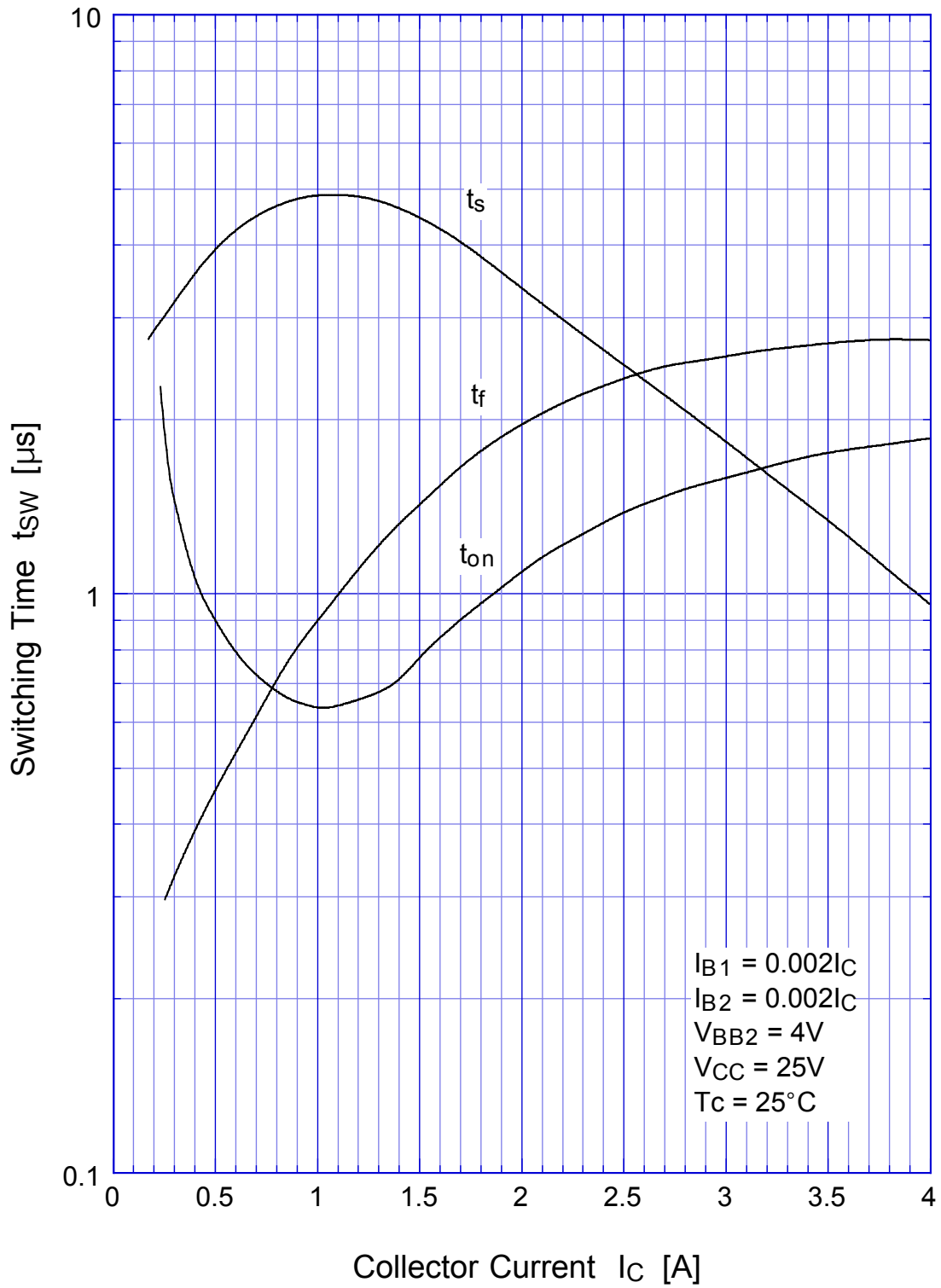

2SD1789

Switching Time - Tc

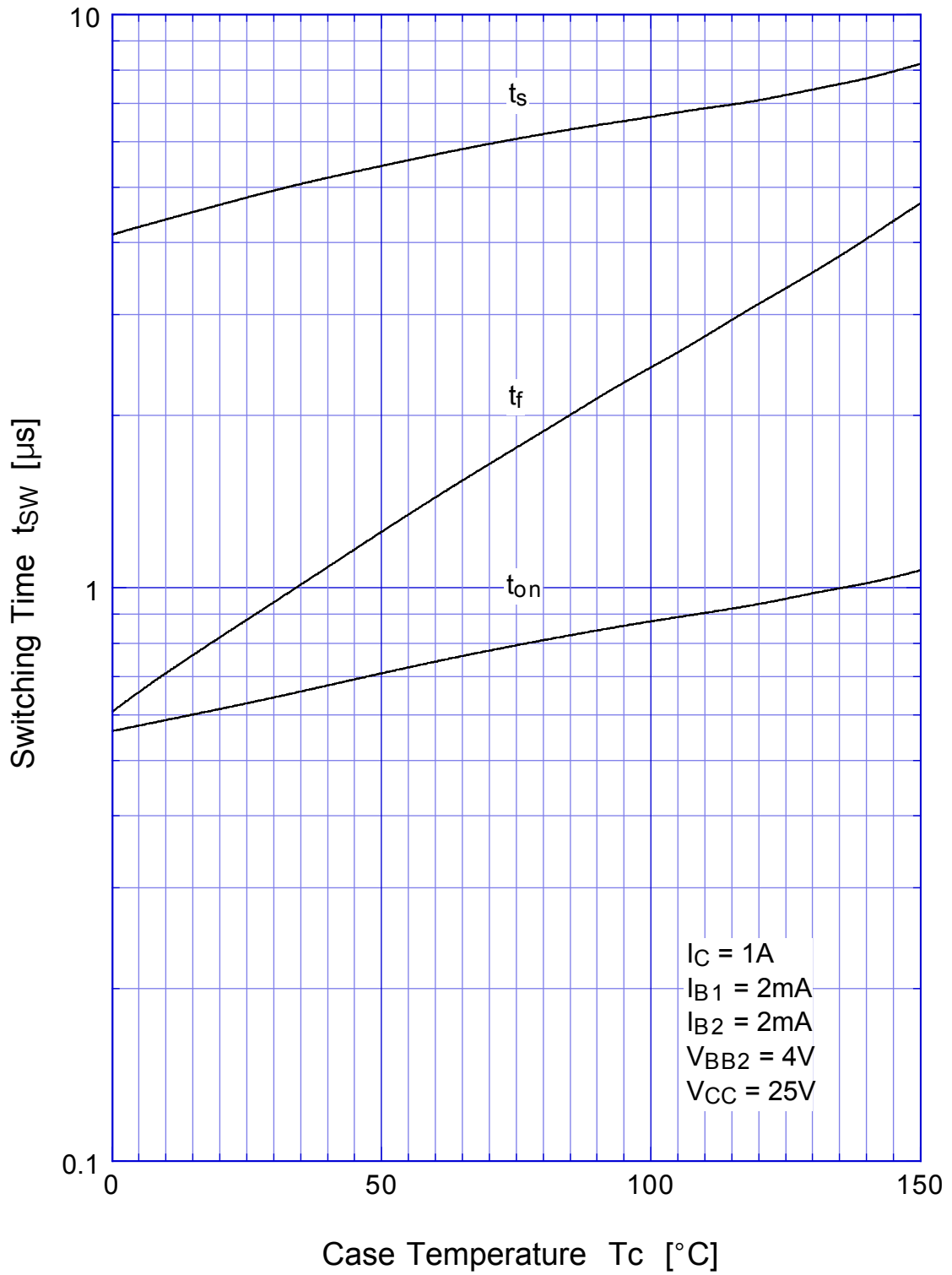

2SD1789 Transient Thermal Impedance

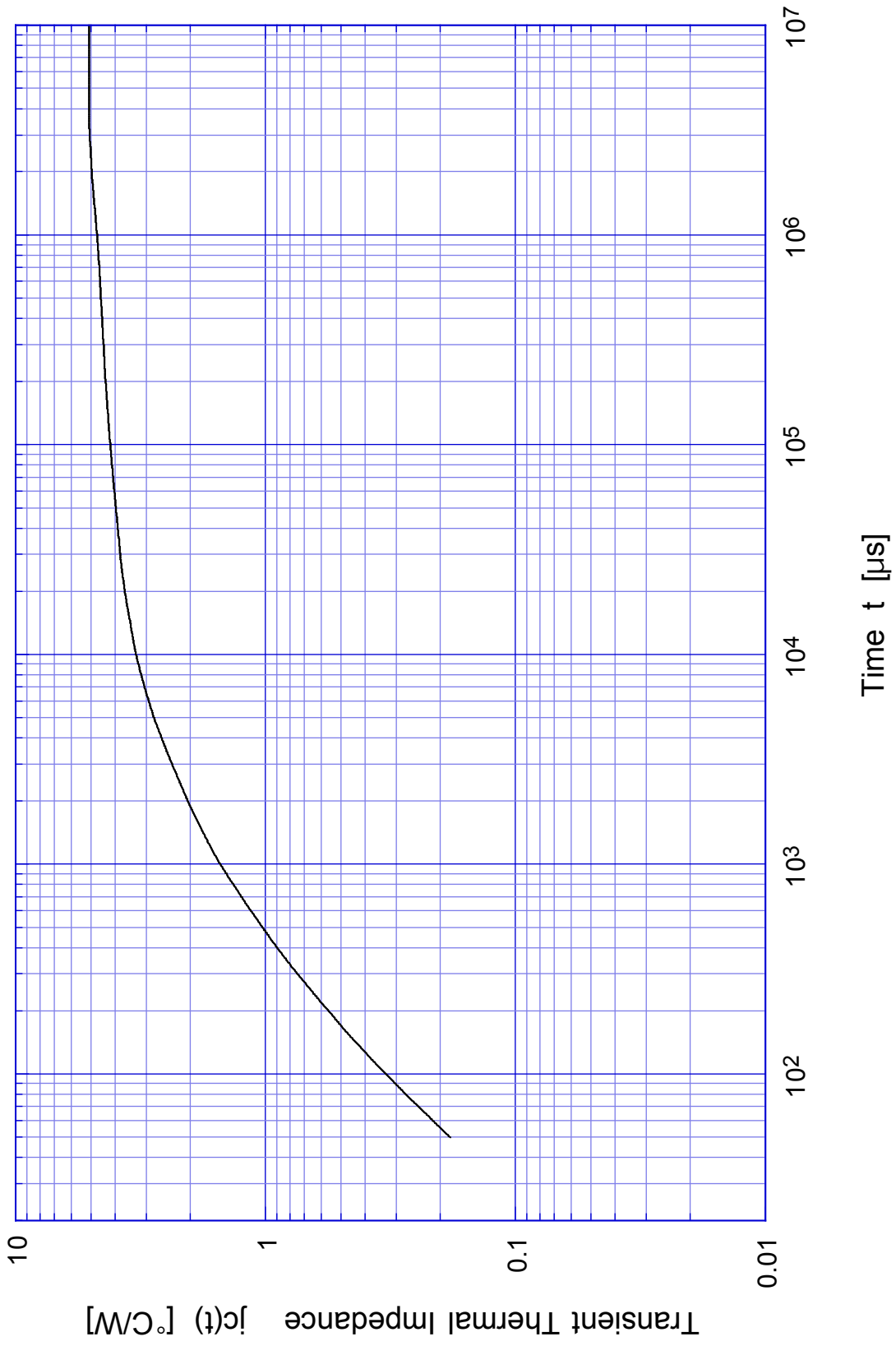

2SD1789 Collector Current Derating

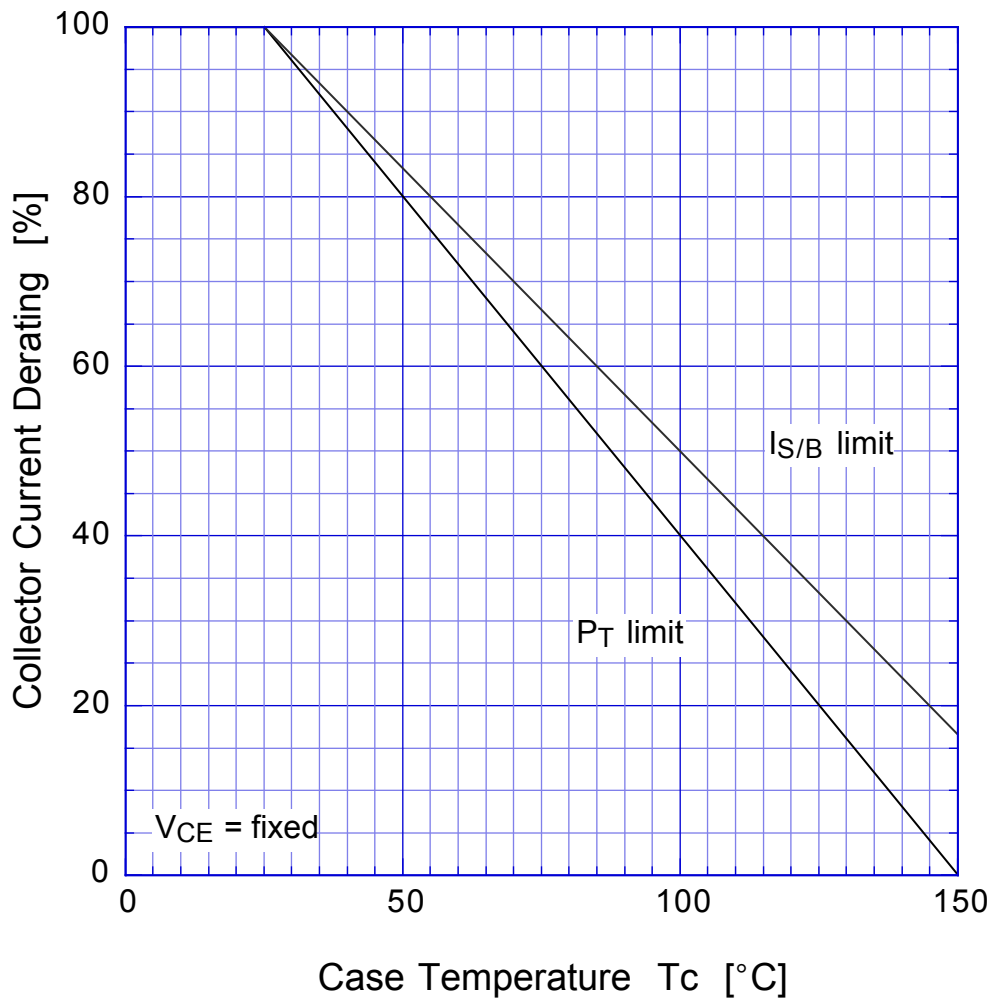

2SD1789

$V_{EC} - I_C$

