

RoHS Compliant Product  
A suffix of "-C" specifies halogen & lead-free

## FEATURES

- Low Collector-to-Emitter Saturation Voltage
- Excellent Linearity of hFE
- High fT
- Fast Switching Time

## MARKING CODE

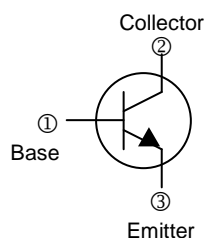
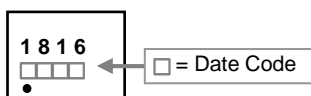

## TO-251

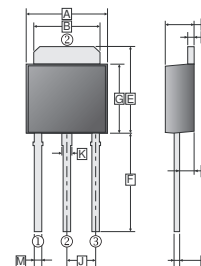
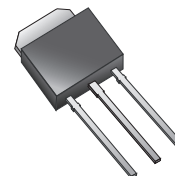

REF.	Millimeter		REF.	Millimeter	
	Min.	Max.		Min.	Max.
A	6.35	6.80	G	5.40	6.25
B	4.90	5.50	H	0.85	1.50
C	2.15	2.40	J		2.30
D	0.43	0.90	K	0.60	1.05
E	6.50	7.50	M	0.50	0.90
F	7.20	9.65	P	0.43	0.62

## ABSOLUTE MAXIMUM RATINGS (T<sub>A</sub> = 25°C unless otherwise specified)

Parameter	Symbol	Ratings	Unit
Collector to Base Voltage	V <sub>CBO</sub>	120	V
Collector to Emitter Voltage	V <sub>CEO</sub>	100	V
Emitter to Base Voltage	V <sub>EBO</sub>	6	V
Collector Current (DC)	I <sub>C</sub>	4	A
Collector Current (Pulse) <sup>1</sup>	I <sub>C</sub>	8	A
Collector Power Dissipation	P <sub>C</sub>	1	W
Junction Temperature	T <sub>J</sub>	150	°C
Storage Temperature	T <sub>STG</sub>	-40 ~ 150	°C

NOTE:

1. Duty=1/2, Pw=20ms
2. Absolute maximum ratings are those values beyond which the device could be permanently damaged. Absolute maximum ratings are stress ratings only and functional device operation is not implied.

## ELECTRICAL CHARACTERISTICS (T<sub>A</sub> = 25°C unless otherwise noted)

Parameter	Symbol	Min.	Typ.	Max.	Unit	Test Conditions
Collector-base breakdown voltage	V <sub>(BR)CBO</sub>	120	-	-	V	I <sub>C</sub> =10μA, I <sub>E</sub> =0
Collector-emitter breakdown voltage	V <sub>(BR)CEO</sub>	100	-	-	V	I <sub>C</sub> =1mA, I <sub>B</sub> =0, R <sub>B</sub> =∞
Emitter-base breakdown voltage	V <sub>(BR)EBO</sub>	6	-	-	V	I <sub>E</sub> =10μA, I <sub>C</sub> =0
Collector cut-off current	I <sub>CBO</sub>	-	-	1	μA	V <sub>CB</sub> =100V, I <sub>E</sub> =0
Emitter cut-off current	I <sub>EBO</sub>	-	-	1	μA	V <sub>EB</sub> =4V, I <sub>C</sub> =0
DC current gain <sup>1</sup>	h <sub>FE</sub>	140	-	280		V <sub>CE</sub> =5V, I <sub>C</sub> =500mA
		40	-	-		V <sub>CE</sub> =5V, I <sub>C</sub> =3A
Collector-emitter saturation voltage <sup>1</sup>	V <sub>CE(sat)</sub>	-	0.15	0.4	V	I <sub>C</sub> =2A, I <sub>B</sub> =200mA
Base-emitter saturation voltage <sup>1</sup>	V <sub>BE(sat)</sub>	-	0.9	1.2	V	I <sub>C</sub> =2A, I <sub>B</sub> =200mA
Transition frequency	f <sub>T</sub>	-	180	-	MHz	V <sub>CE</sub> =10V, I <sub>C</sub> =500mA
Collector Output Capacitance	C <sub>OB</sub>	-	40	-	pF	V <sub>CB</sub> =10V, I <sub>E</sub> =0, f=1MHz
Turn-on time	t <sub>on</sub>	-	100	-	nS	See test circuit
Storage time	t <sub>s</sub>	-	900	-		
Fall time	t <sub>f</sub>	-	50	-		

NOTE:

1. Measured under pulse condition. Pulse width ≤ 300μs, Duty Cycle ≤ 2%

**Switching Time Test Circuit**

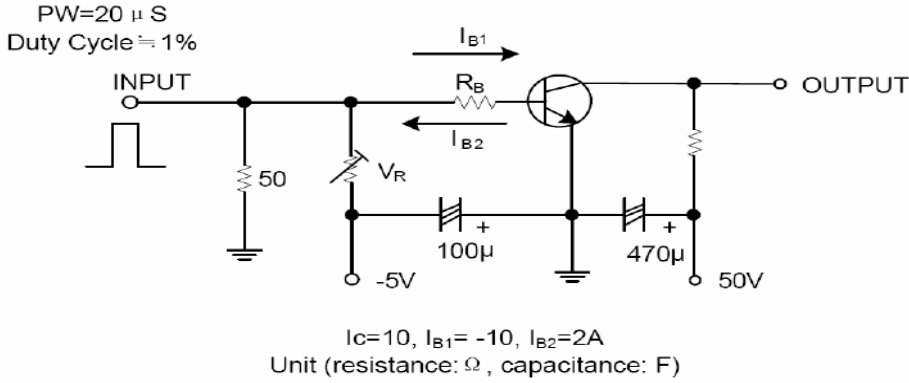

**CHARACTERISTIC CURVES**

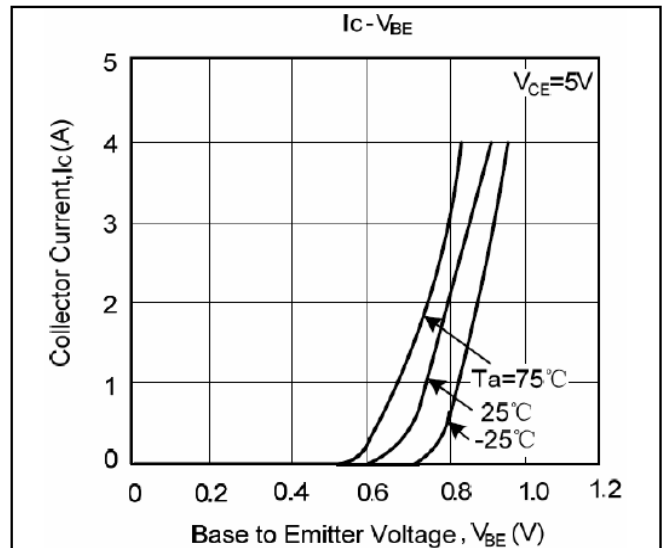
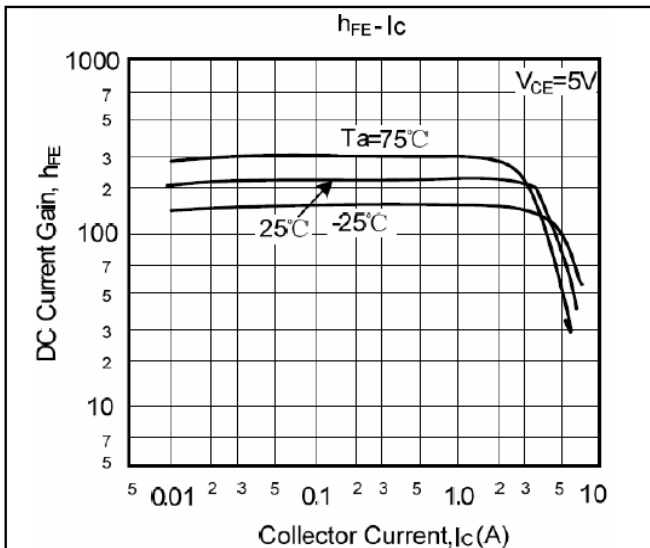
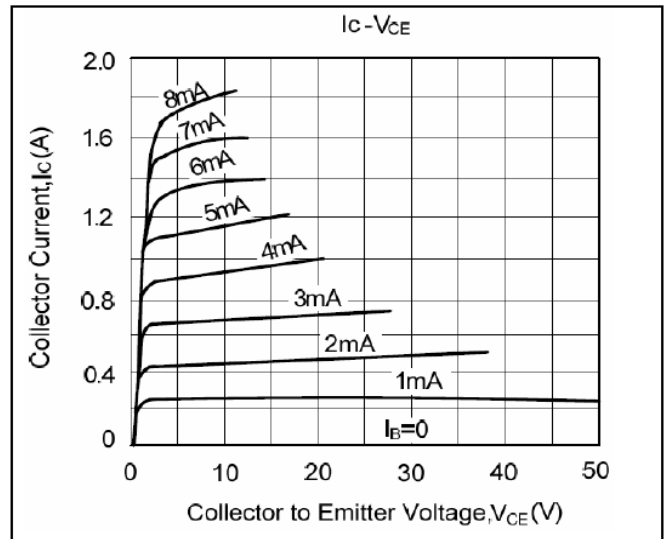
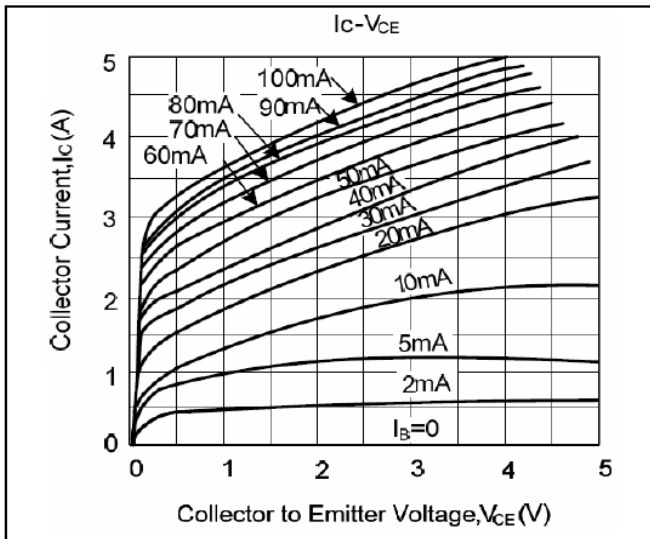

**CHARACTERISTIC CURVES**

