

SHINDENGEN

Darlington Transistor

2SD2196
(TP15L20)

15A NPN

OUTLINE DIMENSIONS

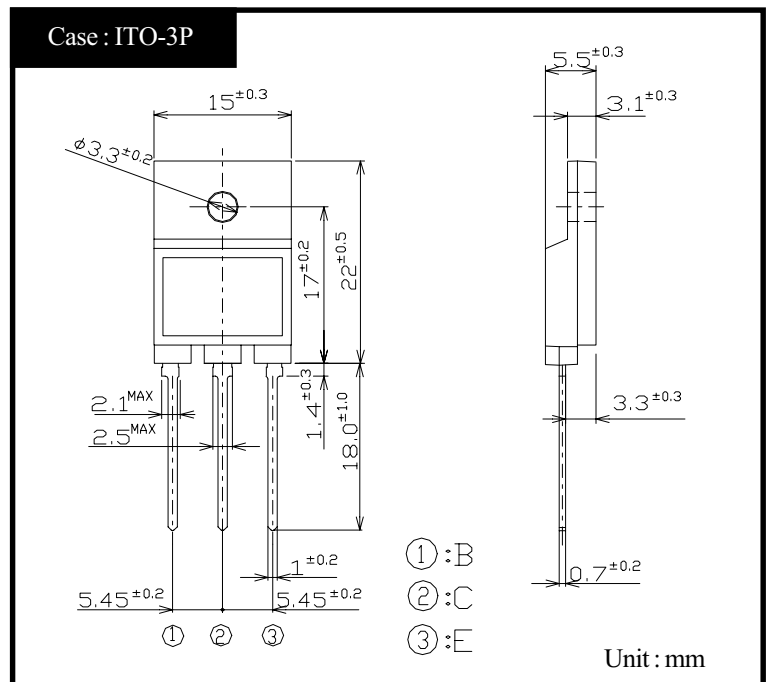

RATINGS

● Absolute Maximum Ratings

Item	Symbol	Conditions	Ratings	Unit
Storage Temperature	T_{stg}		-55~+150	°C
Junction Temperature	T_j		+150	°C
Collector to Base Voltage	V_{CBO}		200	V
Collector to Emitter Voltage	V_{CEO}		200	V
Emitter to Base Voltage	V_{EBO}		7	V
Collector Current DC	I_C		15	A
Collector Current Peak	I_{CP}		22	A
Base Current DC	I_B		1	A
Base Current Peak	I_{BP}		2	A
Total Transistor Dissipation	P_T	$T_C = 25^\circ\text{C}$	65	W
Dielectric Strength	V_{dis}	Terminals to case AC 1 minute	2	kV
Mounting Torque	TOR	(Recommended torque : 0.5N·m)	0.8	N·m

● Electrical Characteristics ($T_C=25^\circ\text{C}$)

Item	Symbol	Conditions	Ratings	Unit
Collector Cutoff Current	I_{CBO}	$V_{CB} = 200\text{V}$	Max 0.1	mA
	I_{CEO}	$V_{CE} = 200\text{V}$	Max 0.1	
Emitter Cutoff Current	I_{EBO}	$V_{EB} = 7\text{V}$	Max 5	mA
DC Current Gain	h_{FE}	$V_{CE} = 3\text{V}, I_C = 10\text{A}$	Min 1,500	
			Max 30,000	
Collector to Emitter Saturation Voltage	$V_{CE(sat)}$	$I_C = 10\text{A}$	Max 1.5	V
Base to Emitter Saturation Voltage	$V_{BE(sat)}$	$I_B = 30\text{mA}$	Max 2.0	V
Thermal Resistance	θ_{jc}	Junction to case	Max 1.92	°C/W
Transition Frequency	f_T	$V_{CE} = 10\text{V}, I_C = 1.5\text{A}$	TYP 20	MHz
Turn on Time	t_{on}	$I_C = 10\text{A}$ $I_{B1} = I_{B2} = 30\text{mA}$ $R_L = 3\Omega$ $V_{BB2} = 4\text{V}$	Max 2	μs
Storage Time	t_s		Max 12	
Fall Time	t_f		Max 5	

2SD2196

$h_{FE} - I_C$

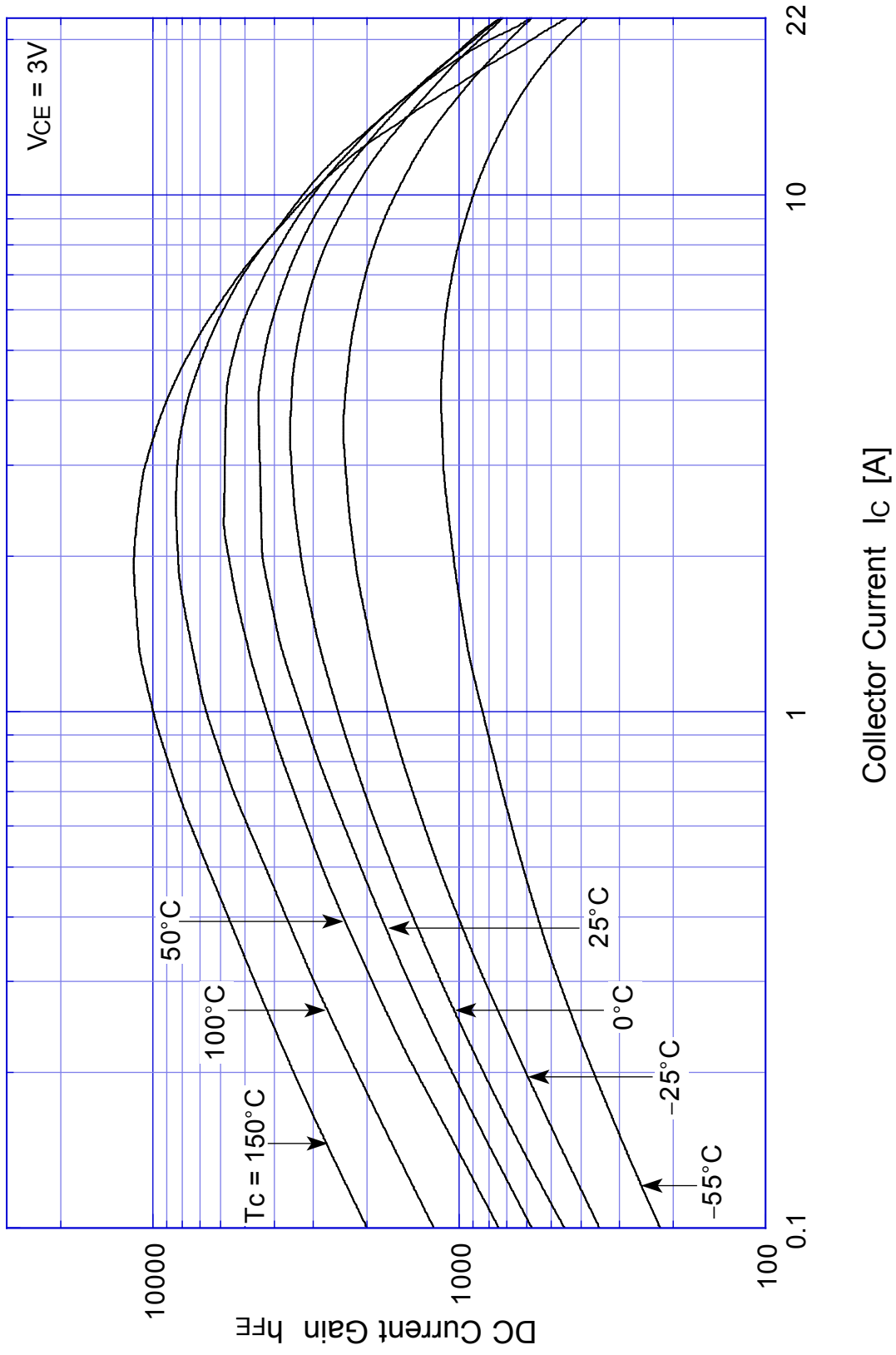

2SD2196

Switching Time - I_C

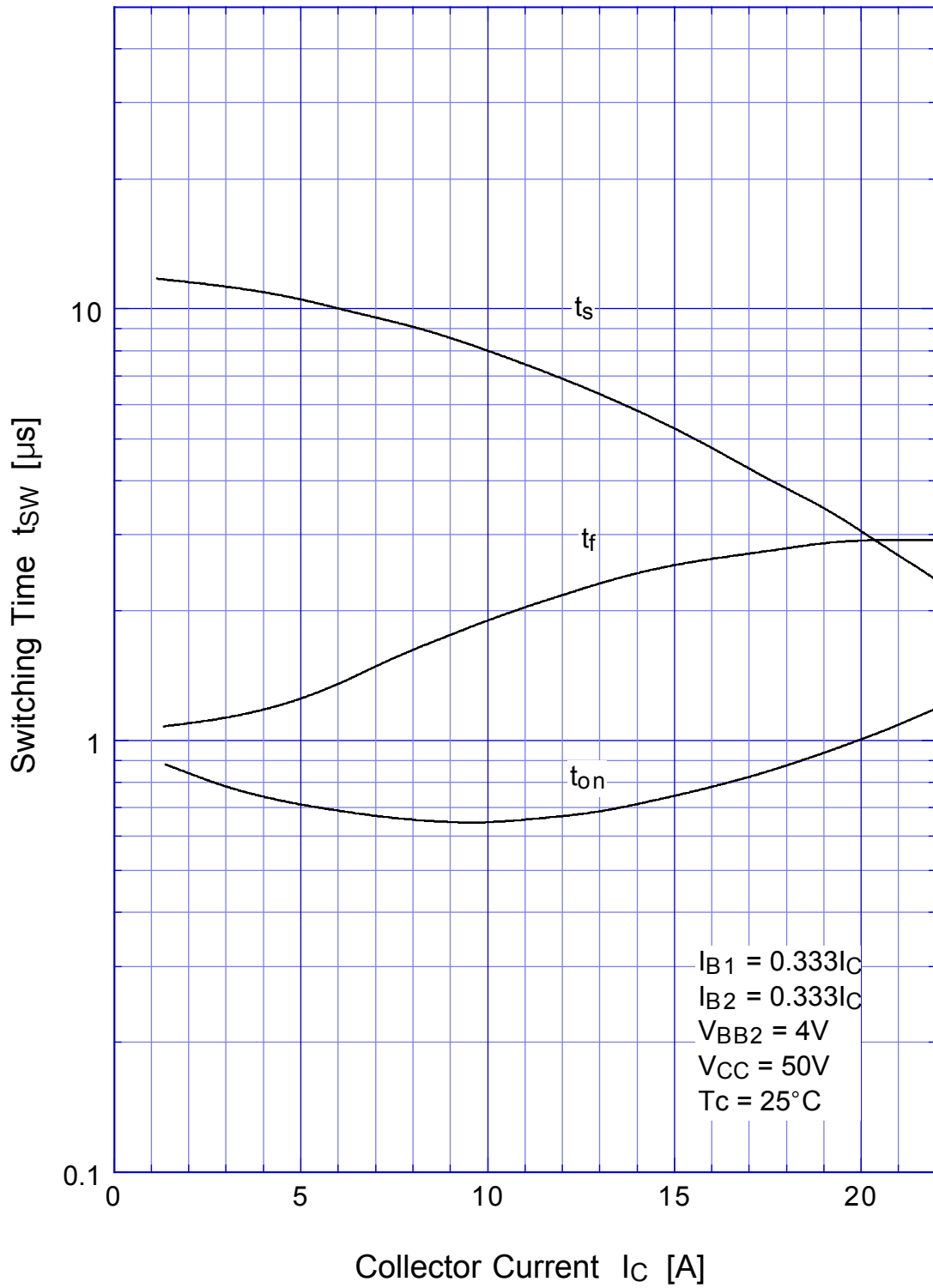

2SD2196

Switching Time

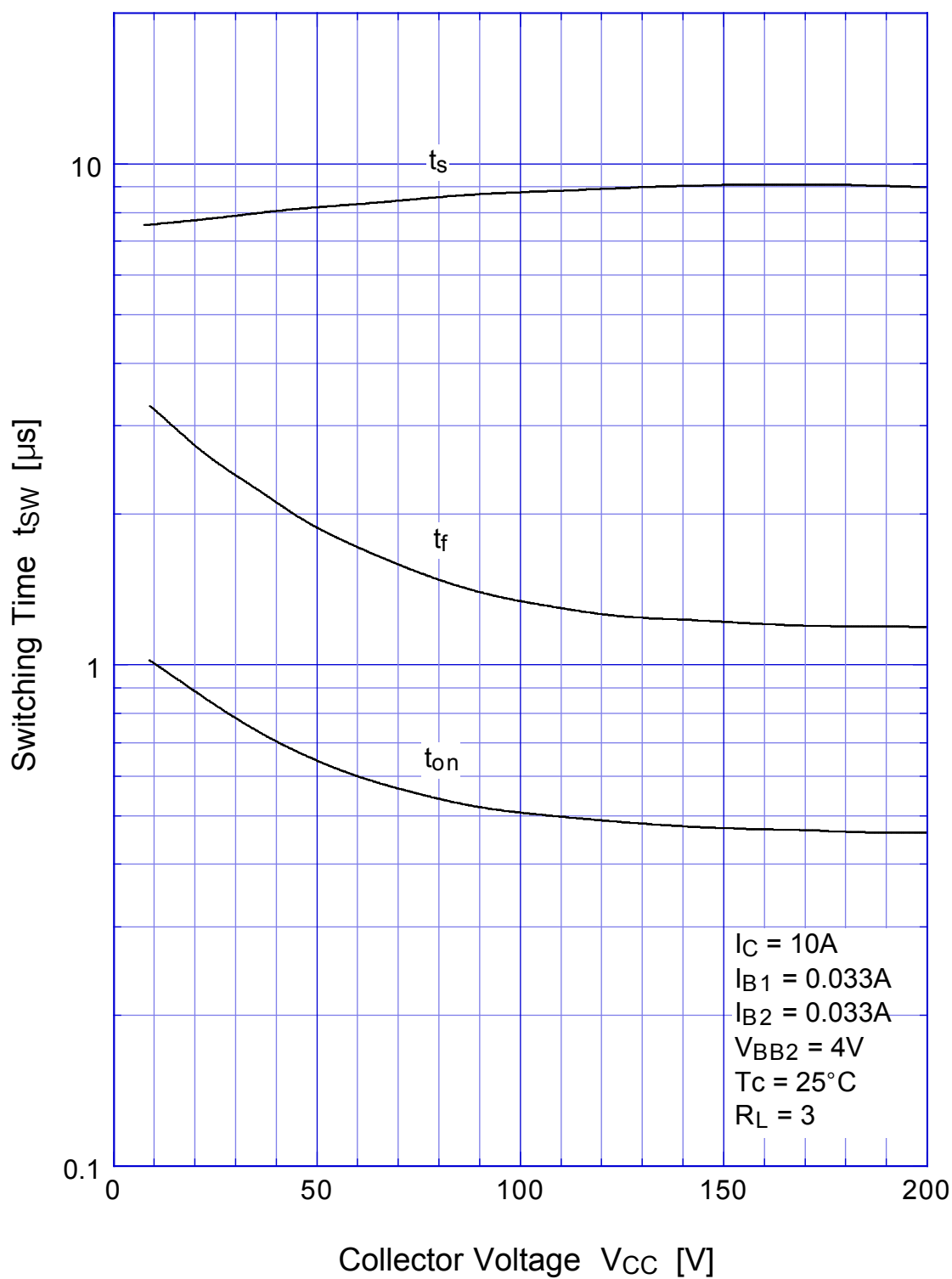

2SD2196

Switching Time - Tc

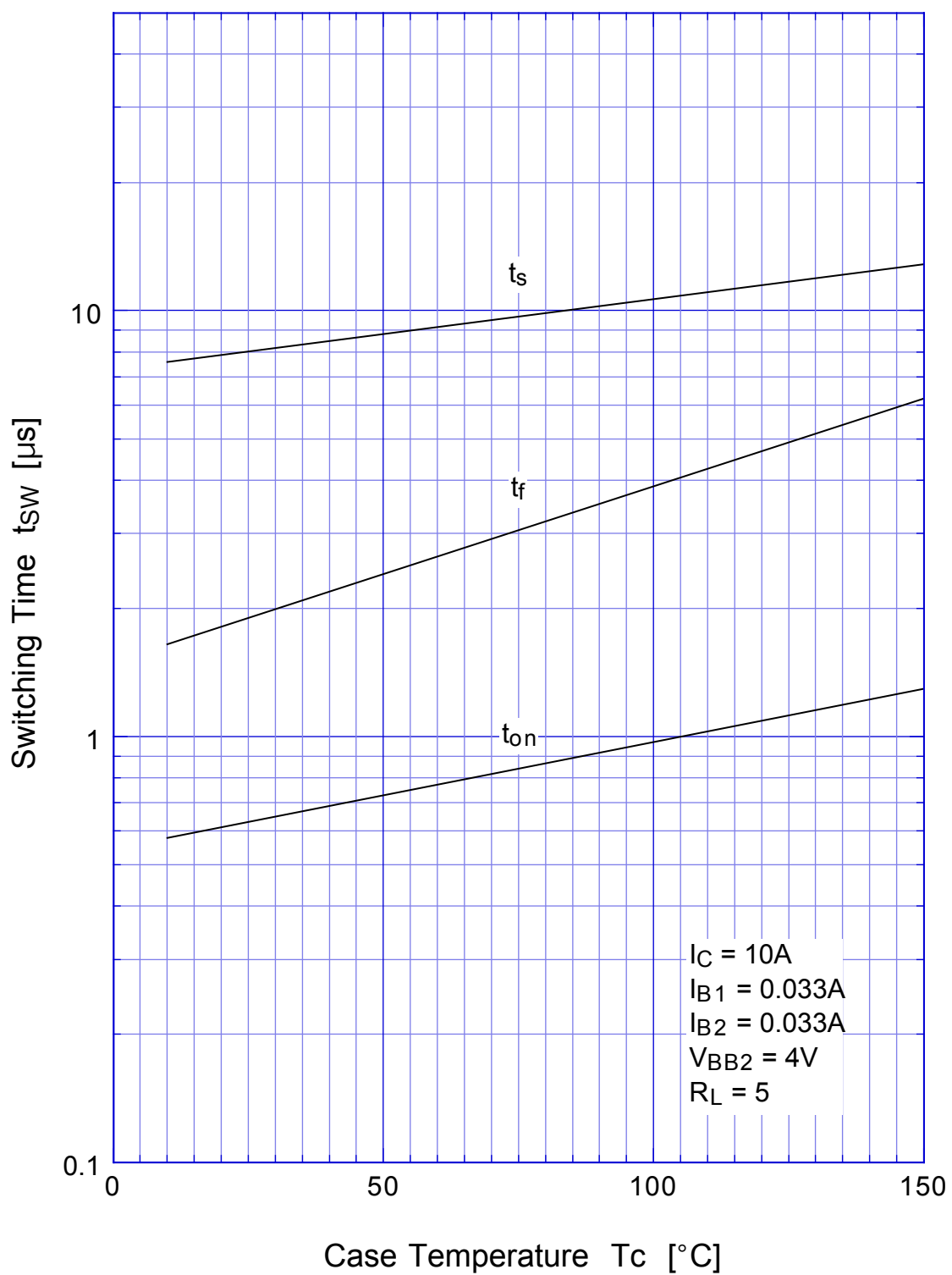

2SD2196 Transient Thermal Impedance

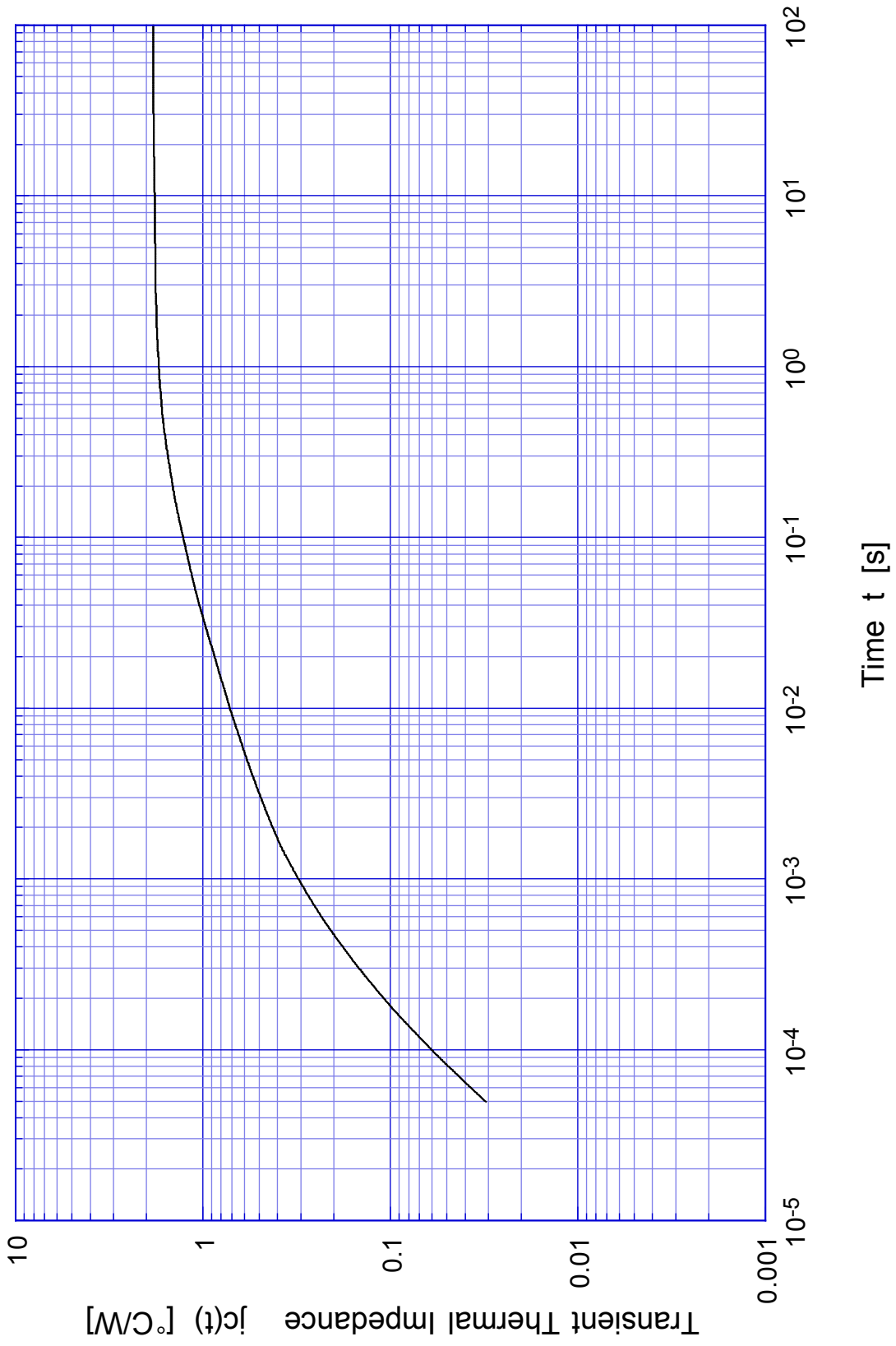

2SD2196

Forward Bias SOA

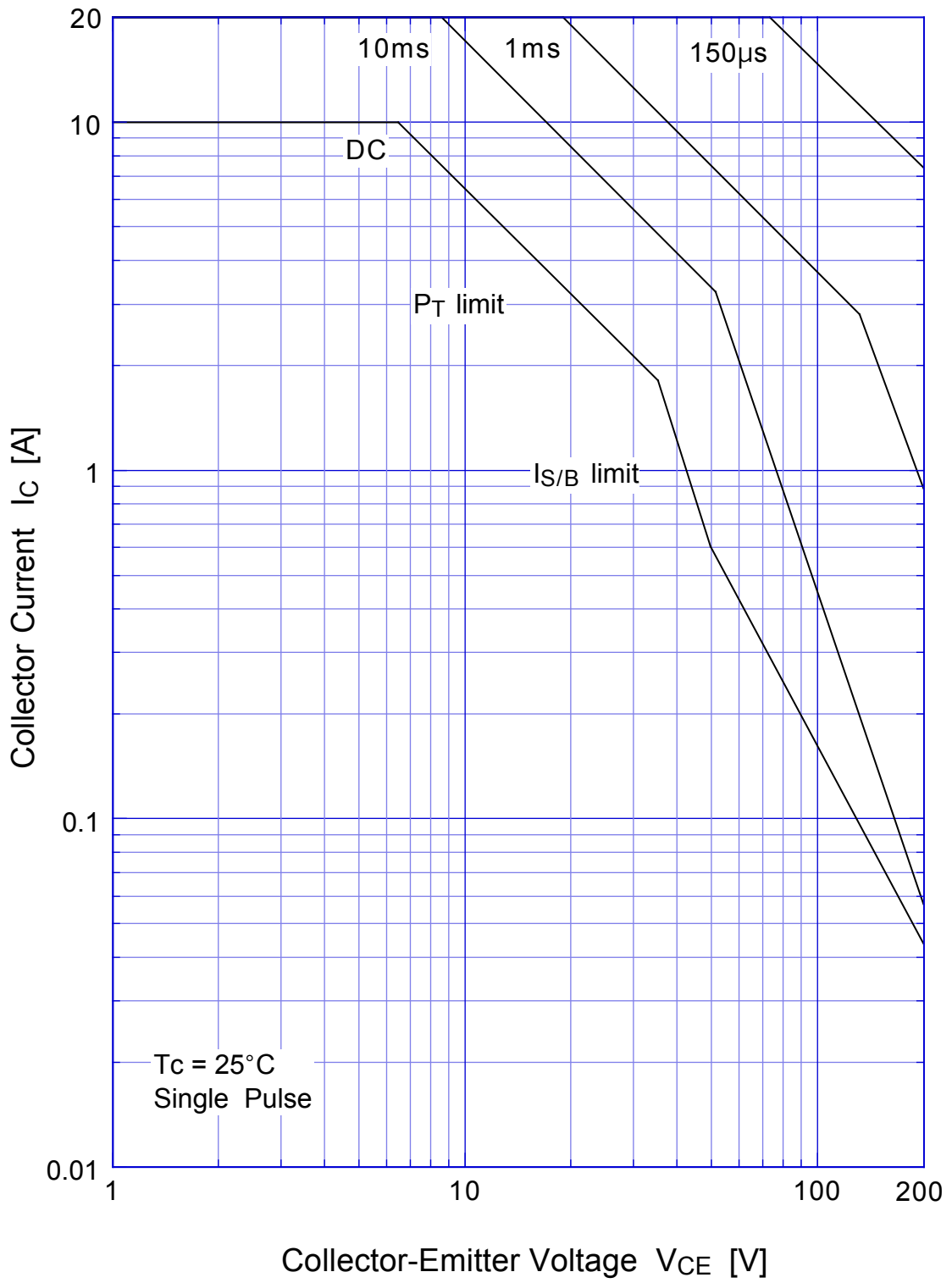

2SD2196 Collector Current Derating

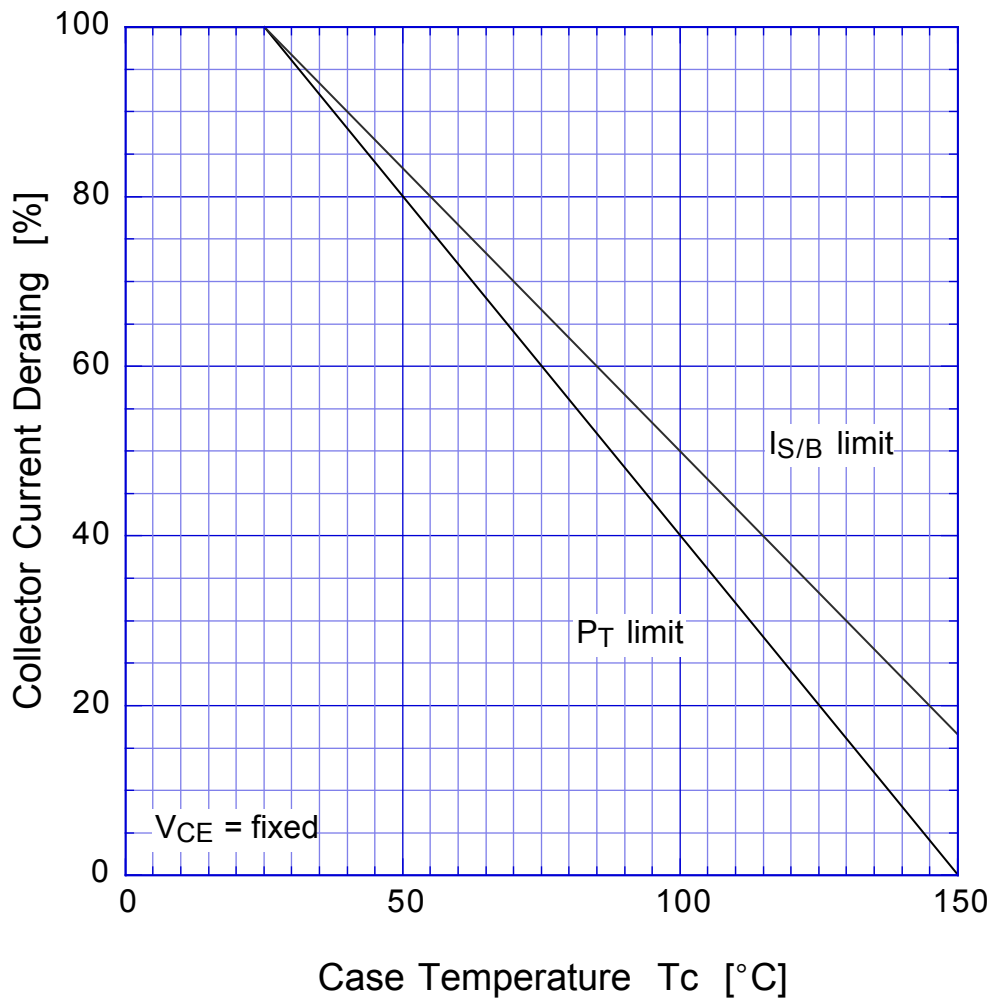

2SD2196

Reverse Bias SOA

