

### 描述 / Descriptions

TO-220F 塑封封装 NPN 半导体三极管。Silicon NPN transistor in a TO-220F Plastic Package.

### 特征 / Features

直流电流增益高,饱和压降低,集电极耗散功率大,安全工作区宽。

High DC current gain, low  $V_{CE(sat)}$ , large collector power dissipation, wide SOA.

### 用途 / Applications

用于低频率功率放大。

Low frequency power amplifier.

### 内部等效电路 / Equivalent Circuit

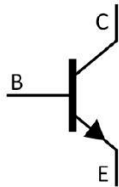

### 引脚排列 / Pinning

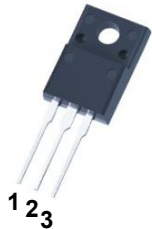

PIN1 : Base      PIN 2 : Collector      PIN 3 : Emitter

### 放大及印章代码 / $h_{FE}$ Classifications & Marking

$h_{FE}$ Classifications Symbol	H	J	K
$h_{FE}$ Range	400~800	600~1200	1000~2000

**极限参数 / Absolute Maximum Ratings(Ta=25°C)**

参数 Parameter	符号 Symbol	数值 Rating	单位 Unit
Collector to Base Voltage	$V_{CBO}$	80	V
Collector to Emitter Voltage	$V_{CEO}$	60	V
Emitter to Base Voltage	$V_{EBO}$	6.0	V
Collector Current - Continuous	$I_C$	3.0	A
Collector Current – Continuous(Pulse)	$I_{CP}$	6.0	A
Collector Power Dissipation	$P_C$	2.0	W
	$P_C(T_c=25^\circ C)$	30	W
Junction Temperature	$T_j$	150	°C
Storage Temperature Range	$T_{stg}$	-55~150	°C

**电性能参数 / Electrical Characteristics(Ta=25°C)**

参数 Parameter	符号 Symbol	测试条件 Test Conditions	最小值 Min	典型值 Typ	最大值 Max	单位 Unit
Collector to Base Breakdown Voltage	$V_{CBO}$	$I_C=50\mu A$	80			V
Collector to Emitter Breakdown Voltage	$V_{CEO}$	$I_C=1.0mA$	60			V
Emitter to Base Breakdown Voltage	$V_{EBO}$	$I_E=50\mu A$	6.0			V
Collector Cut-Off Current	$I_{CBO}$	$V_{CB}=80V$ $I_E=0$			100	$\mu A$
Emitter Cut-Off Current	$I_{EBO}$	$V_{EB}=6.0V$ $I_C=0$			100	$\mu A$
DC Current Gain	$h_{FE}$	$V_{CE}=4.0V$ $I_C=500mA$	400	1000	2000	
Collector to Emitter Saturation Voltage	$V_{CE(sat)}$	$I_C=2.0A$ $I_B=0.05A$		0.3	0.8	V
Base to Emitter Voltage	$V_{BE(sat)}$	$I_C=2.0A$ $I_B=0.05A$			1.5	V
Transition Frequency	$f_T$	$V_{CE}=5.0V$ $f=10MHz$ $I_C=0.2A$		40		MHz
Collector output capacitance	$C_{ob}$	$V_{CB}=10V$ $f=1.0MHz$ $I_E=0$		55		pF

电参数曲线图 / Electrical Characteristic Curve

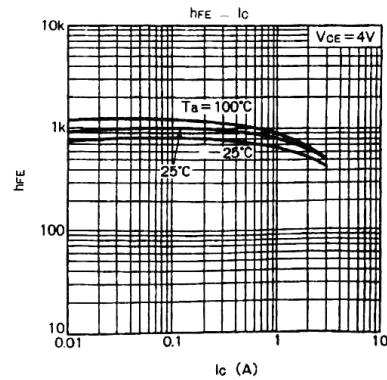
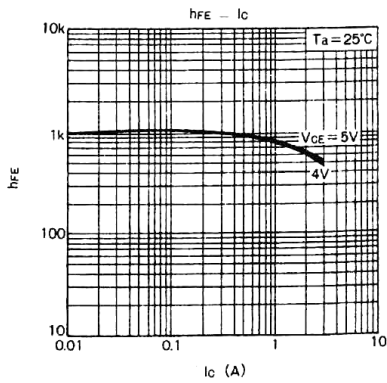
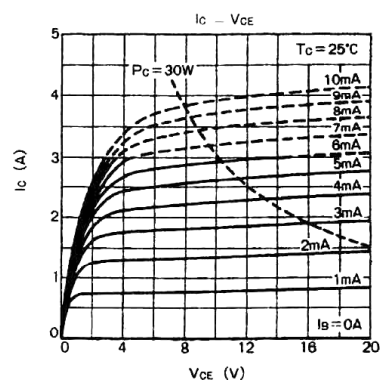
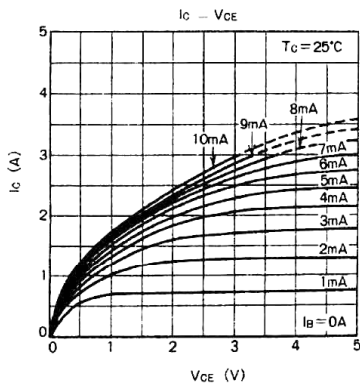
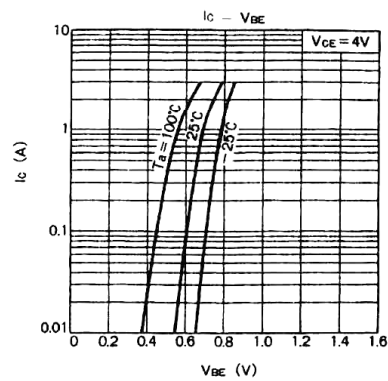
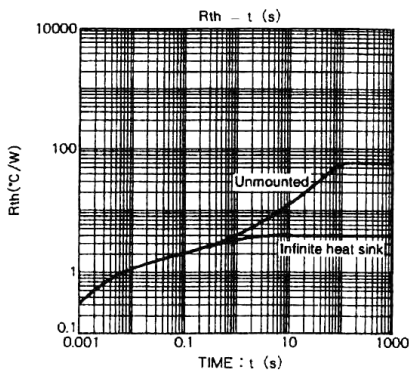
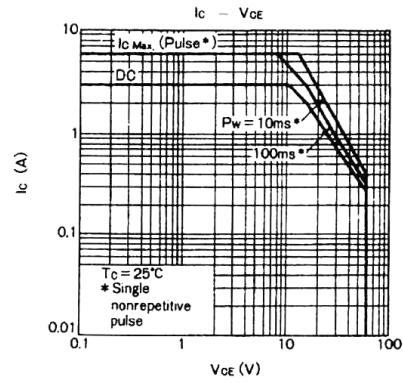
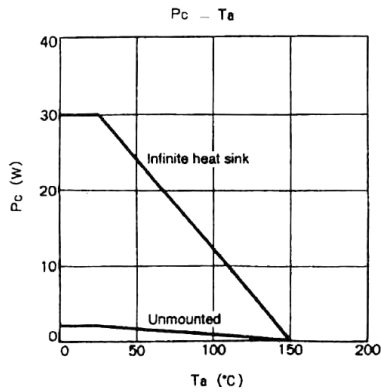

外形尺寸图 / Package Dimensions

T0-220F

单位: mm

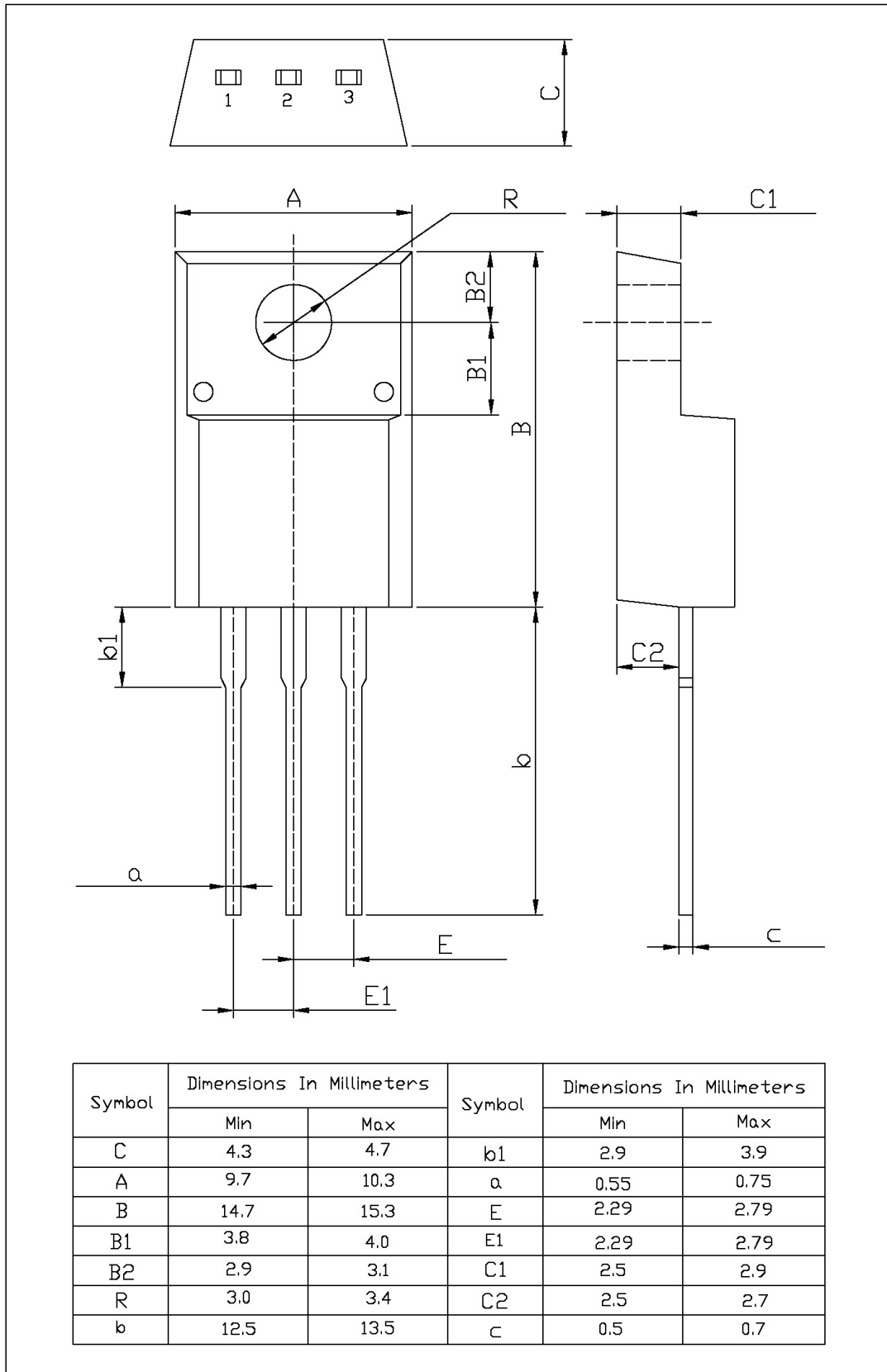

印章说明 / Marking Instructions

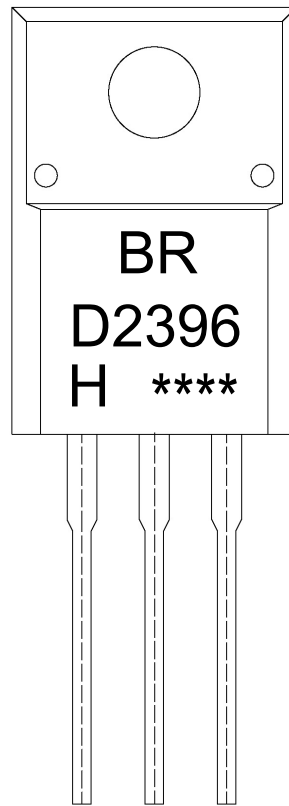

说明：

BR： 为公司代码

D2396： 为型号代码

H： 为  $h_{FE}$  分档代码

\*\*\*\*： 为生产批号代码，随生产批号变化。

Note:

BR: Company Code.

D2396: Product Type.

H:  $h_{FE}$  Classifications Symbol

\*\*\*\*: Lot No. Code, code change with Lot No.

**波峰焊温度曲线图(无铅) / Temperature Profile for Dip Soldering(Pb-Free)**



说明：

- 1、预热温度 25 ~ 150°C，时间 60 ~ 90sec;
- 2、峰值温度 255±5°C，时间持续为 5±0.5sec;
- 3、焊接制程冷却速度为 2 ~ 10°C/sec.

Note:

- 1.Preheating:25~150°C, Time:60~90sec.
- 2.Peak Temp.:255±5°C, Duration:5±0.5sec.
3. Cooling Speed: 2~10°C/sec.

**耐焊接热试验条件 / Resistance to Soldering Heat Test Conditions**

温度：270±5°C

时间：10±1 sec.

Temp.:270±5°C

Time:10±1 sec

**包装规格 / Packaging SPEC.**

散件包装 / BULK

Package Type 封装形式	Units 包装数量					Dimension 包装尺寸 (unit: mm <sup>3</sup> )		
	Units/Bag 只/袋	Bags/Inner Box 袋/盒	Units/Inner Box 只/盒	Inner Boxes/Outer Box 盒/箱	Units/Outer Box 只/箱	Bag 袋	Inner Box 盒	Outer Box 箱
TO-220/F	200	10	2,000	5	10,000	135×190	237×172×102	560×245×195

套管包装 / TUBE

Package Type 封装形式	Units 包装数量					Dimension 包装尺寸 (unit: mm <sup>3</sup> )		
	Units/Tube 只/套管	Tubes/Inner Box 套管/盒	Units/Inner Box 只/盒	Inner Boxes/Outer Box 盒/箱	Units/Outer Box 只/箱	Tube 套管	Inner Box 盒	Outer Box 箱
TO-220/F	50	20	1,000	5	5,000	532×31.4×5.5	555×164×50	575×290×180

**使用说明 / Notices**