

NPN SILICON EPITAXIAL TRANSISTOR
MP-3

DESCRIPTION

2SD992-Z is designed for Audio Frequency Amplifier and Switching, especially in Hybrid Integrated Circuits.

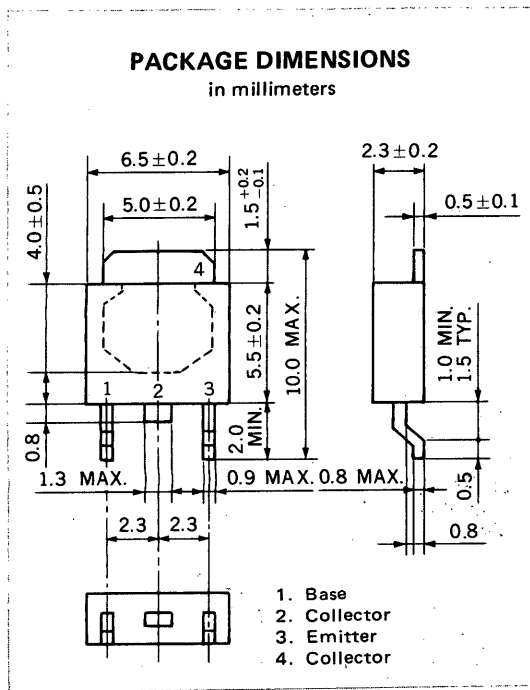

FEATURES

- Low $V_{CE(sat)}$: $V_{CE(sat)} = 0.3$ V TYP.
- B-E Resistor, Built-in
- Complement to 2SB962-Z

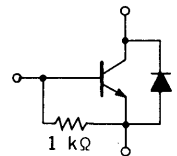

ABSOLUTE MAXIMUM RATINGS

Maximum Voltages and Currents ($T_a = 25^\circ\text{C}$)

Collector to Base Voltage	V_{CBO}	30	V
Collector to Emitter Voltage	V_{CEO}	30	V
Emitter to Base Voltage	V_{EBO}	5	V
Collector Current (DC)	I_C	2	A
Collector Current (Pulse)*	I_C	3	A

Maximum Power Dissipation

Total Power Dissipation at 25°C Ambient Temperature**	P_T	2.0	W
--	-------	-----	---

Maximum Temperatures

Junction Temperature	T_j	150	$^\circ\text{C}$
Storage Temperature Range	T_{stg}	-55 to +150	$^\circ\text{C}$

* $PW \leq 10$ ms, Duty Cycle ≤ 50 %

**When mounted on ceramic substrate of $2.5\text{ cm}^2 \times 0.7\text{ mm}$

ELECTRICAL CHARACTERISTICS ($T_a = 25^\circ\text{C}$)

CHARACTERISTIC	SYMBOL	MIN.	TYP.	MAX.	UNIT	TEST CONDITIONS
Collector Cutoff Current	I_{CBO}			10	μA	$V_{CB} = 20\text{ V}, I_E = 0$
DC Current Gain	h_{FE1}^{***}	35		200		$V_{CE} = 0.5\text{ V}, I_C = 0.1\text{ A}$
DC Current Gain	h_{FE2}^{***}	50				$V_{CE} = 0.5\text{ V}, I_C = 2.0\text{ A}$
Collector Saturation Voltage	$V_{CE(sat)}^{***}$		0.3	0.5	V	$I_C = 2.0\text{ A}, I_B = 40\text{ mA}$
Base Saturation Voltage	$V_{BE(sat)}^{***}$		0.95	1.5	V	$I_C = 2.0\text{ A}, I_B = 40\text{ mA}$

***Pulsed: $PW \leq 350\ \mu\text{s}$, Duty Cycle ≤ 2 %

h_{FE} Classification

MARKING	N	M	L	K
h_{FE1}	35 to 80	60 to 120	80 to 120	100 to 200

TYPICAL CHARACTERISTICS ($T_a = 25^\circ\text{C}$)

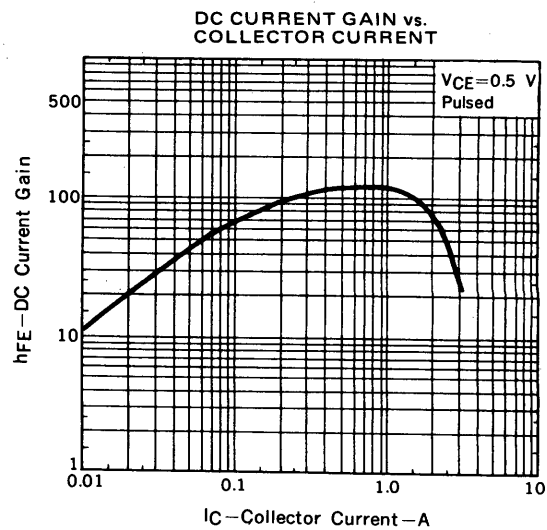
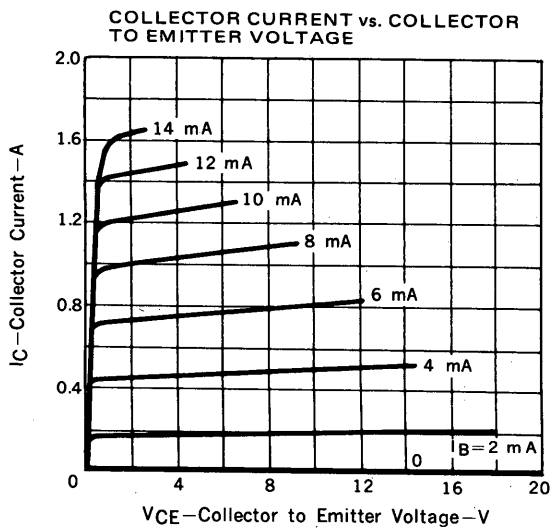
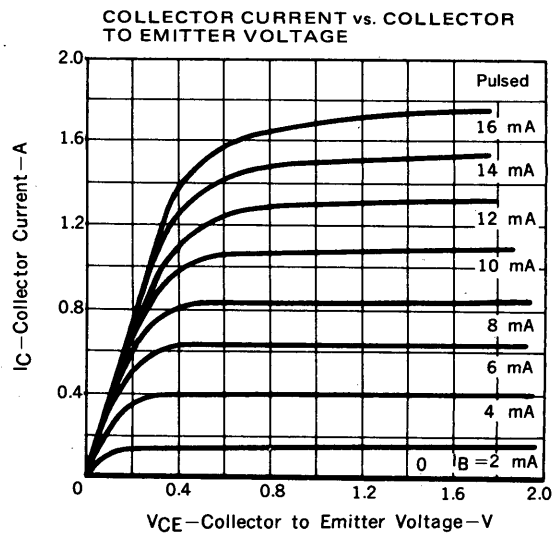
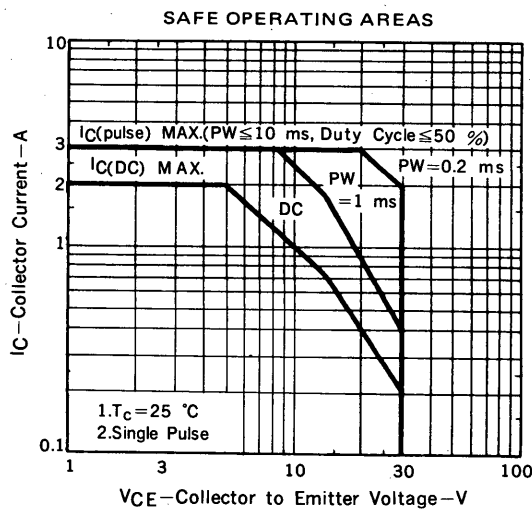
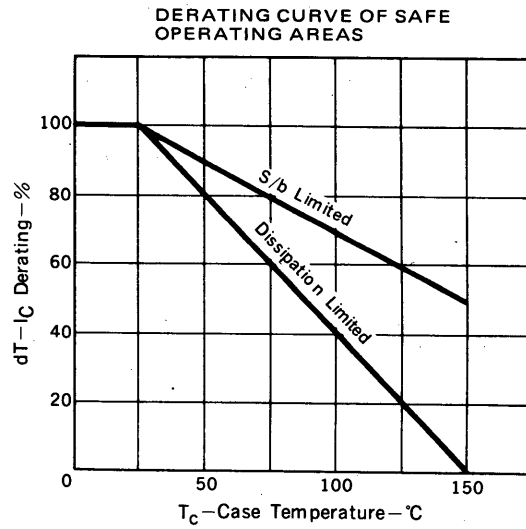
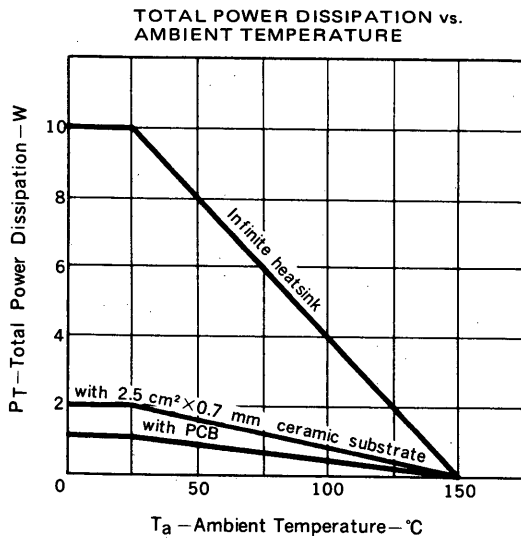

BASE AND COLLECTOR SATURATION VOLTAGE vs. COLLECTOR CURRENT

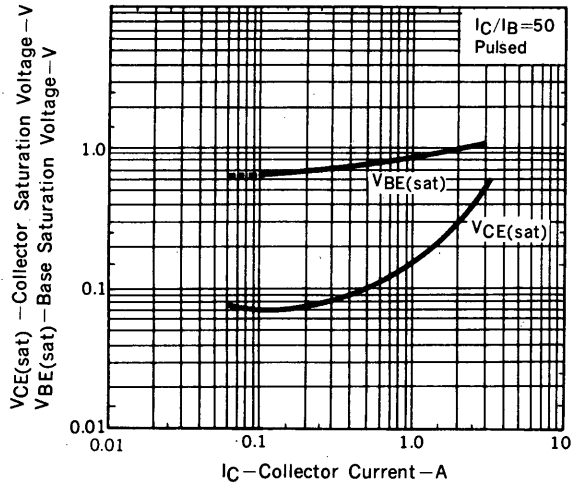

FORWARD CURRENT vs. FORWARD VOLTAGE

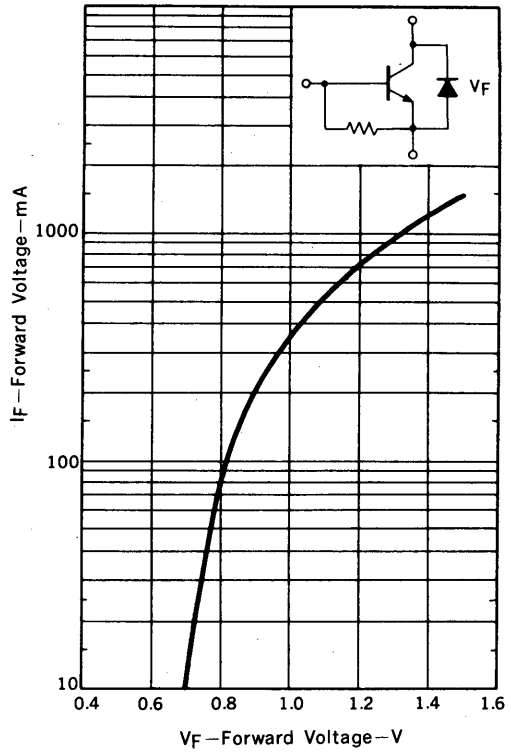

NEC Corporation

INTERNATIONAL ELECTRON DEVICES DIV.
SUMITOMO MITA Building, 37-8,
Shiba Gochome, Minato-ku, Tokyo 108, Japan
Tel: Tokyo 456-3111
Telex Address: NECTOK J22686
Cable Address: NEC TOKYO

TC-1666
JULY-10-85M
Printed in Japan