

2SJ389 , 2SJ389

Silicon P Channel MOS FET

Application

High speed power switching

Features

- Low on-resistance
- High speed switching
- Low drive current
- 4 V gate drive device can be driven from 5 V source
- Suitable for Switching regulator, DC – DC converter
- Avalanche Ratings

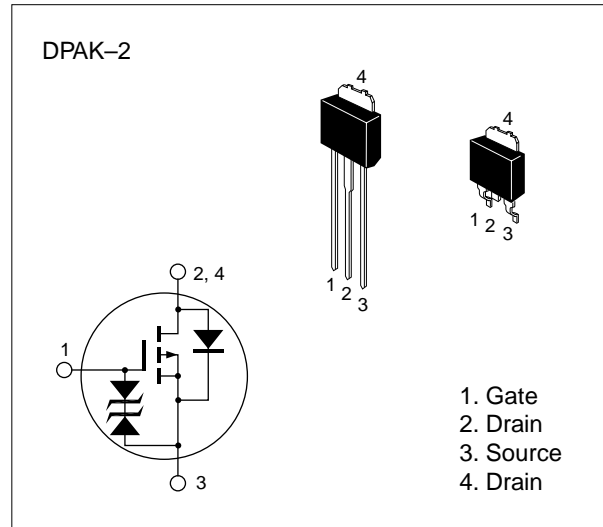

Table 1 Absolute Maximum Ratings (Ta = 25°C)

Item	Symbol	Ratings	Unit
Drain to source voltage	V _{DSS}	-60	V
Gate to source voltage	V _{GSS}	±20	V
Drain current	I _D	-10	A
Drain peak current	I _{D(pulse)} *	-40	A
Body-drain diode reverse drain current	I _{DR}	-10	A
Avalanche current	I _{AP} ***	-10	A
Avalanche energy	E _{AR} ***	8.5	mJ
Channel dissipation	P _{ch} **	30	W
Channel temperature	T _{ch}	150	°C
Storage temperature	T _{stg}	-55 to +150	°C

* PW ≤ 10 μs, duty cycle ≤ 1 %

** Value at T_c = 25 °C

*** Value at T_{ch} = 25 °C, R_g ≥ 50 Ω

Table 2 Electrical Characteristics (Ta = 25°C)

Item	Symbol	Min	Typ	Max	Unit	Test conditions
Drain to source breakdown voltage	$V_{(BR)DSS}$	-60	—	—	V	$I_D = -10 \text{ mA}$, $V_{GS} = 0$
Gate to source breakdown voltage	$V_{(BR)GSS}$	± 20	—	—	V	$I_G = \pm 100 \text{ }\mu\text{A}$, $V_{DS} = 0$
Gate to source leak current	I_{GSS}	—	—	± 10	μA	$V_{GS} = \pm 16 \text{ V}$, $V_{DS} = 0$
Zero gate voltage drain current	I_{DSS}	—	—	-100	μA	$V_{DS} = -50 \text{ V}$, $V_{GS} = 0$
Gate to source cutoff voltage	$V_{GS(off)}$	-1.0	—	-2.25	V	$I_D = -1 \text{ mA}$, $V_{DS} = -10 \text{ V}$
Static drain to source on state resistance	$R_{DS(on)}$	—	0.1	0.135	Ω	$I_D = -5 \text{ A}$ $V_{GS} = -10 \text{ V}^*$
		—	0.14	0.2	Ω	$I_D = -5 \text{ A}$ $V_{GS} = -4 \text{ V}^*$
Forward transfer admittance	$ y_{fs} $	4	8	—	S	$I_D = -5 \text{ A}$ $V_{DS} = -10 \text{ V}^*$
Input capacitance	C_{iss}	—	910	—	pF	$V_{DS} = -10 \text{ V}$
Output capacitance	C_{oss}	—	440	—	pF	$V_{GS} = 0$
Reverse transfer capacitance	C_{rss}	—	170	—	pF	$f = 1 \text{ MHz}$
Turn-on delay time	$t_{d(on)}$	—	15	—	ns	$I_D = -5 \text{ A}$
Rise time	t_r	—	85	—	ns	$V_{GS} = -10 \text{ V}$
Turn-off delay time	$t_{d(off)}$	—	220	—	ns	$R_L = 6 \text{ }\Omega$
Fall time	t_f	—	145	—	ns	
Body-drain diode forward voltage	V_{DF}	—	-1.0	—	V	$I_F = -10 \text{ A}$, $V_{GS} = 0$
Body-drain diode reverse recovery time	t_{rr}	—	170	—	μs	$I_F = -10 \text{ A}$, $V_{GS} = 0$, $diF / dt = 50 \text{ A} / \mu\text{s}$

* Pulse Test

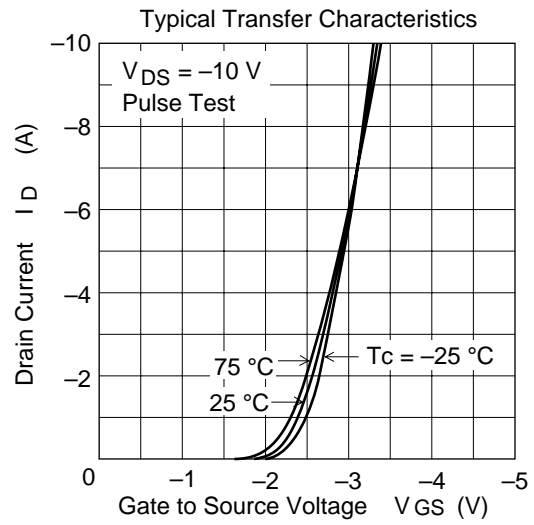
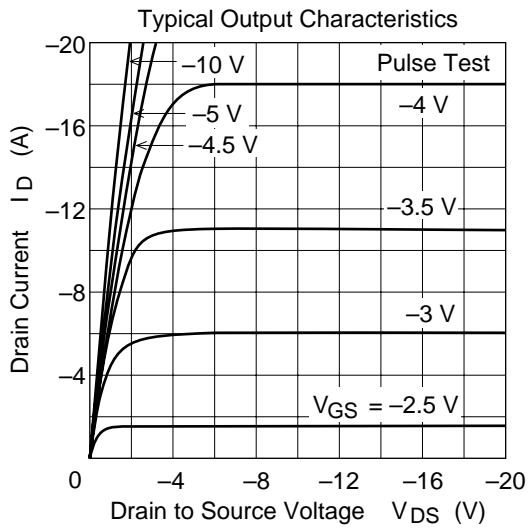
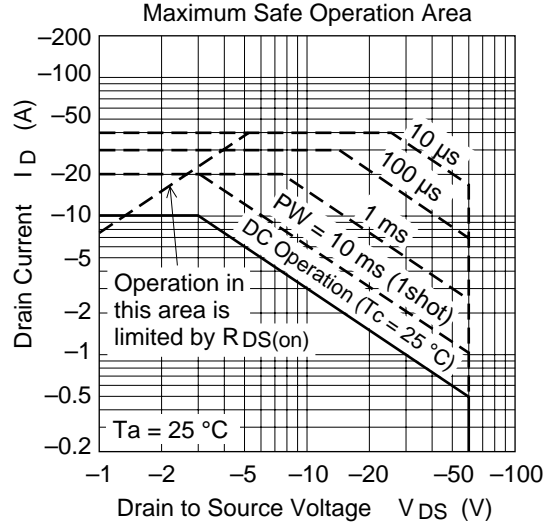
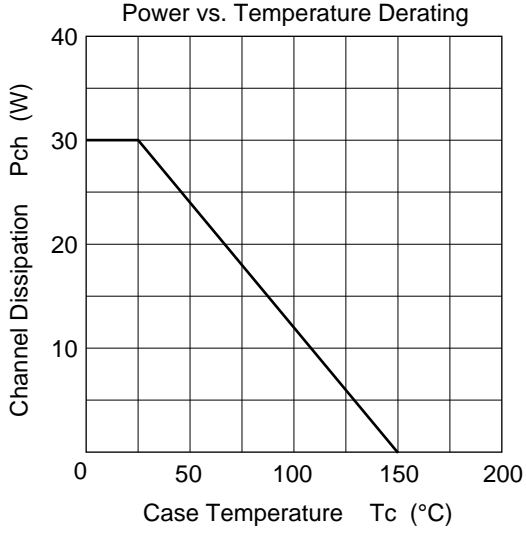

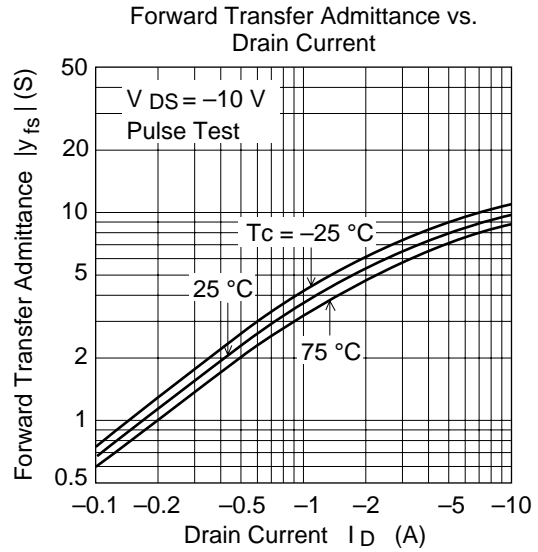
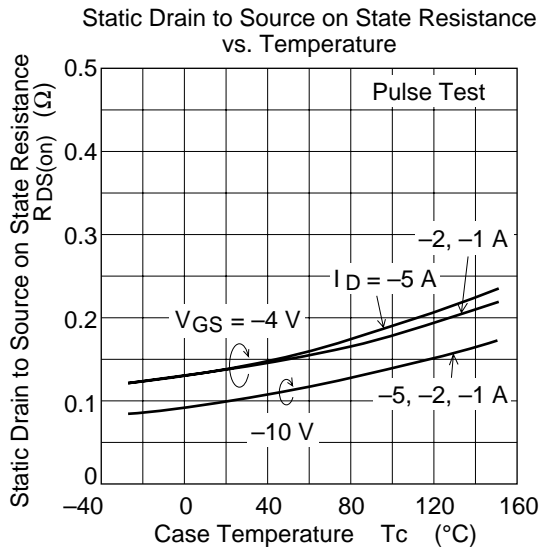
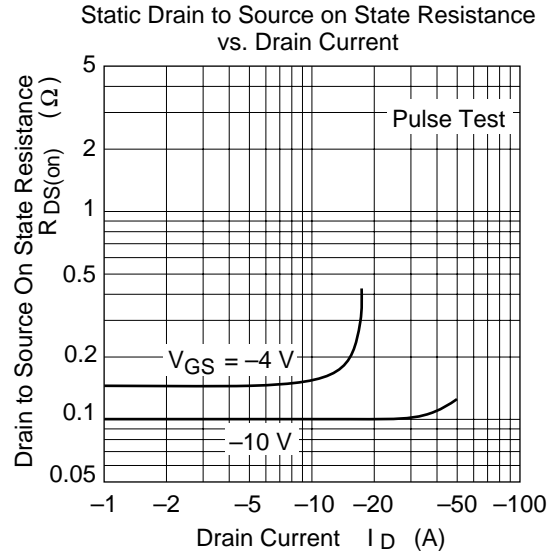
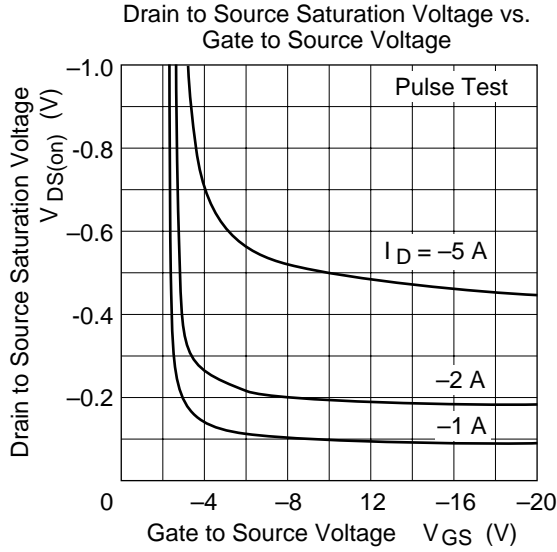

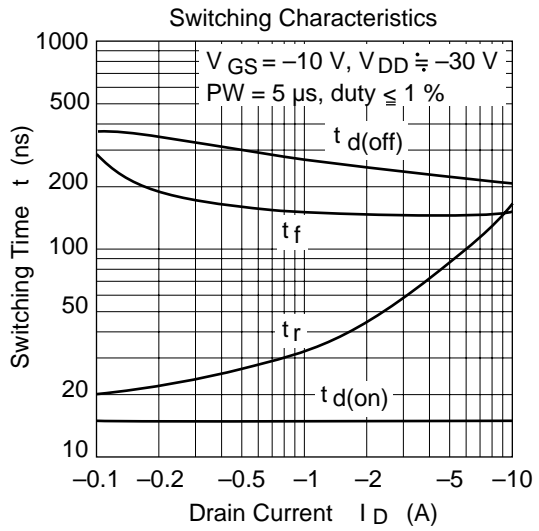
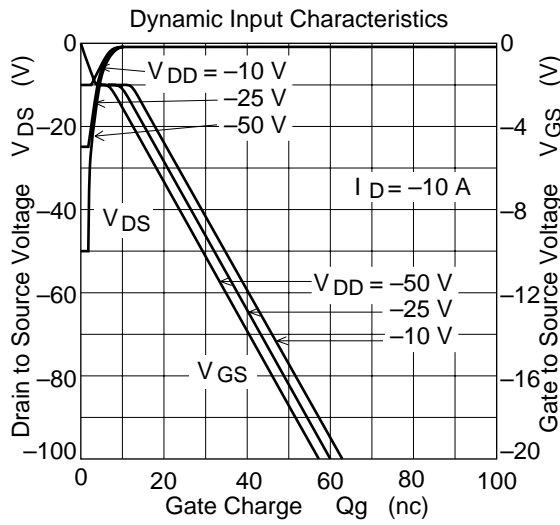
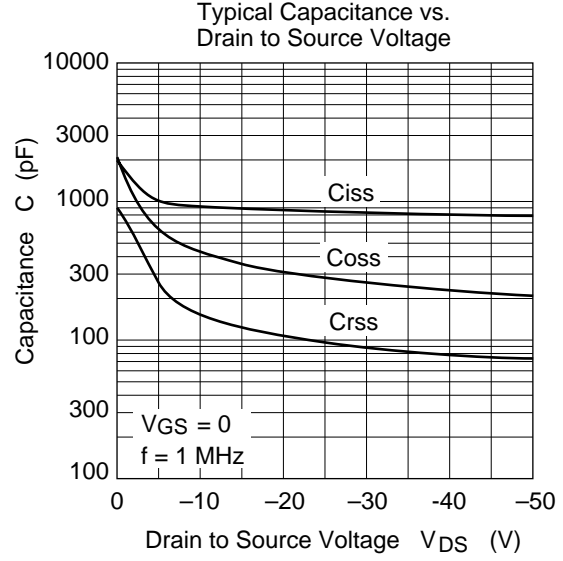
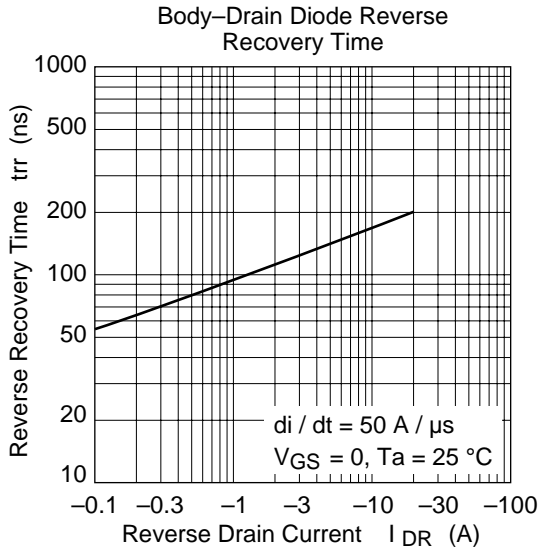

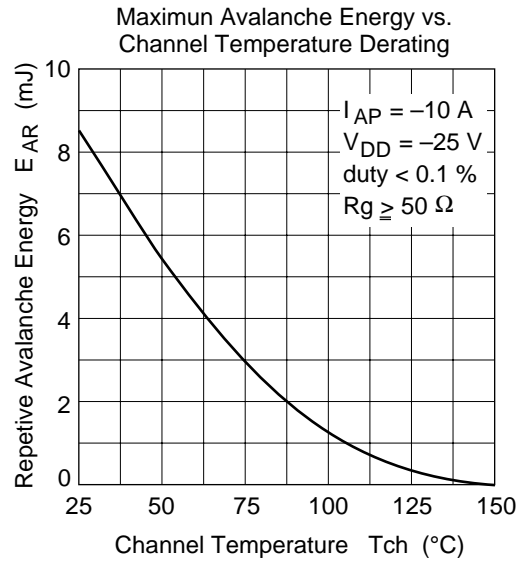
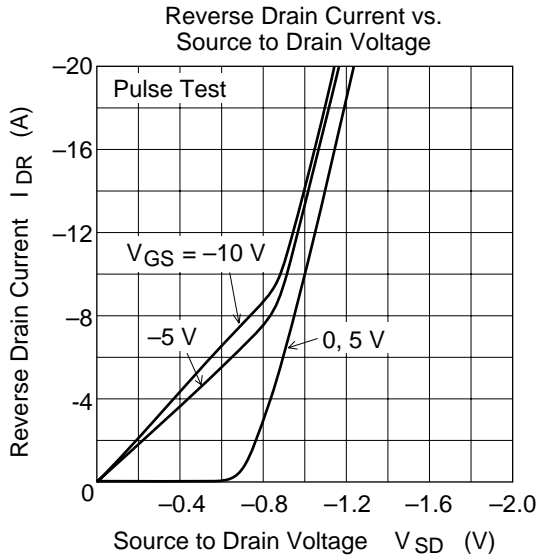

Avalanche Test Circuit and Waveform

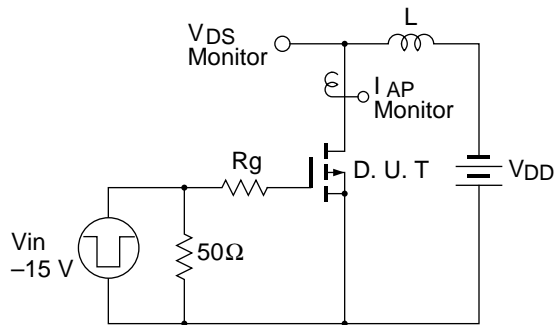

$$E_{AR} = \frac{1}{2} \cdot L \cdot I_{AP}^2 \cdot \frac{V_{DSS}}{V_{DSS} - V_{DD}}$$

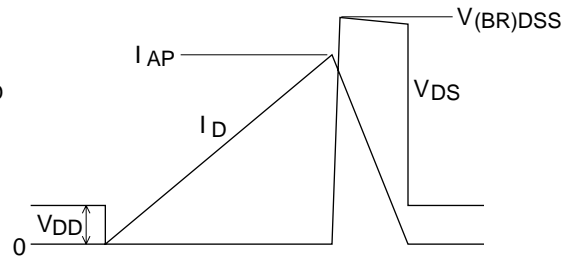

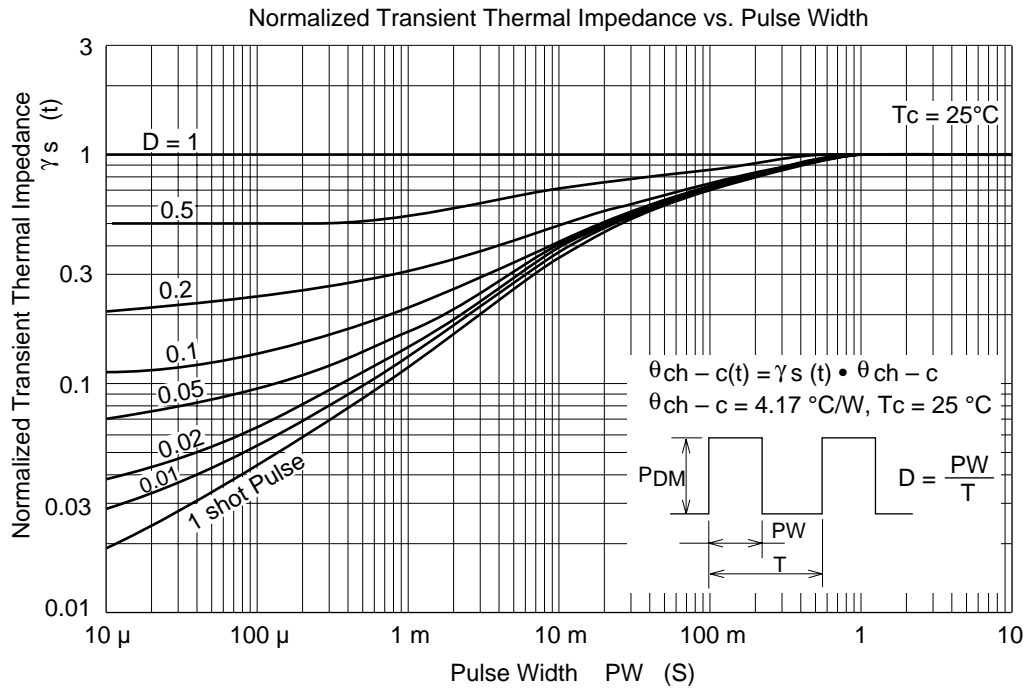

Switching Time Test Circuit

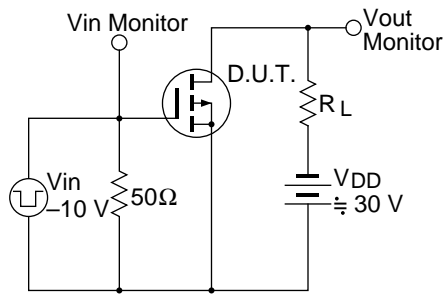

Waveforms

