



2SK303

JFET

LOW-FREQUENCY GENERAL-PURPOSE AMPLIFIER APPLICATIONS

FEATURES

- * Ideal For Potentiometers
- * Analog Switches
- * Low Frequency Amplifiers
- * Constant Current Supplies
- * Impedance Conversion

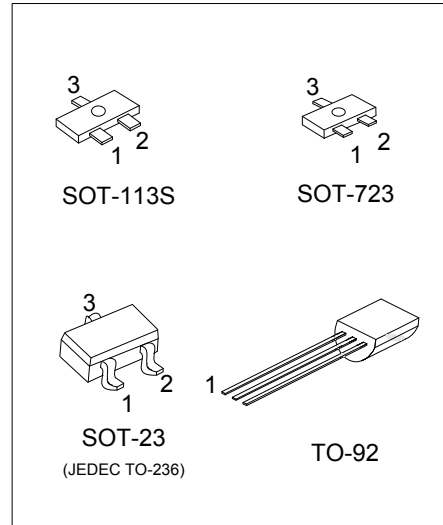

ORDERING INFORMATION

Ordering Number		Package	Pin Assignment			Packing
Lead Free	Halogen Free		1	2	3	
2SK303L-xx-AE3-R	2SK303G-xx-AE3-R	SOT-23	S	D	G	Tape Reel
2SK303L-xx-A3C-R	2SK303G-xx-A3C-R	SOT-113S	S	D	G	Tape Reel
2SK303L-xx-AQ3-R	2SK303G-xx-AQ3-R	SOT-723	S	D	G	Tape Reel
2SK303L-xx-T92-B	2SK303G-xx-T92-B	TO-92	G	S	D	Tape Box
2SK303L-xx-T92-K	2SK303G-xx-T92-K	TO-92	G	S	D	Bulk

Note: Pin Assignment: S: Source D: Drain G: Gate

<p>2SK303G-xx-AE3-R</p> <p>(1) Packing Type (2) Package Type (3) Rank (4) Green Package</p>	<p>(1) B: Tape Box, K: Bulk, R: Tape Reel (2) AE3: SOT-23, T92: TO-92, A3C: SOT-113S AQ3: SOT-723 (3) x: Refer to Classification of I_{DSS} (4) G: Halogen Free and Lead Free, L: Lead Free</p>
---	--

MARKING

SOT-23 / SOT-113S / SOT-723			
2SK303-V2	2SK303-V3	2SK303-V4	2SK303-V5
<p>L: Lead Free G: Halogen Free</p>	<p>L: Lead Free G: Halogen Free</p>	<p>L: Lead Free G: Halogen Free</p>	<p>L: Lead Free G: Halogen Free</p>

For TO-92

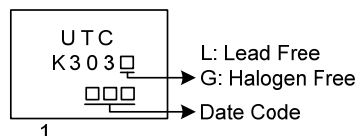

■ ABSOLUTE MAXIMUM RATINGS ($T_A = 25^\circ\text{C}$, unless otherwise specified)

PARAMETER		SYMBOL	RATINGS	UNIT
Drain to Source Voltage		V_{DSS}	30	V
Gate to Source Voltage		V_{GSS}	-30	V
Gate Current		I_G	10	mA
Drain Current		I_D	20	mA
Power Dissipation	SOT-23	P_D	200	mW
	SOT-113S/SOT-723		100	
	TO-92		625	
Junction Temperature		T_J	+150	$^\circ\text{C}$
Storage Temperature		T_{STG}	-55 ~ +150	$^\circ\text{C}$

Note: Absolute maximum ratings are those values beyond which the device could be permanently damaged. Absolute maximum ratings are stress ratings only and functional device operation is not implied.

■ ELECTRICAL CHARACTERISTICS ($T_A = 25^\circ\text{C}$, unless otherwise specified)

PARAMETER	SYMBOL	TEST CONDITIONS	MIN	TYP	MAX	UNIT
OFF CHARACTERISTICS						
Gate to Drain Breakdown Voltage	BV_{GDS}	$I_G = -10\mu\text{A}$	-30			V
Drain-Source Leakage Current	I_{DSS}	$V_{DS} = 10\text{V}, V_{GS} = 0\text{V}$	0.6		12.0	mA
Gate-Source Leakage Current	I_{GSS}	$V_{GS} = -20\text{V}$			-1.0	nA
ON CHARACTERISTICS						
Gate Cutoff Voltage	$V_{GS(OFF)}$	$V_{DS} = 10\text{V}, I_D = 1\mu\text{A}$		-1	-4	V
Drain-Source On-State Resistance	$R_{DS(ON)}$	$V_{DS} = 10\text{mV}, V_{GS} = 0\text{V}$		250		Ω
Forward Transfer Admittance	$ Y_{FS} $	$V_{DS} = 10\text{V}, V_{GS} = 0\text{V}, f = 1\text{MHz}$	2.5	6.0		mS
DYNAMIC PARAMETERS						
Input Capacitance	C_{ISS}	$V_{DS} = 10\text{V}, V_{GS} = 0\text{V}, f = 1\text{MHz}$		5		pF
Reverse Transfer Capacitance	C_{RSS}			1.5		pF

■ CLASSIFICATION OF I_{DSS}

RANK	V2	V3	V4	V5
I_{DSS} (mA)	0.6 ~ 1.5	1.2 ~ 3.0	2.5 ~ 6.0	5.0 ~ 12.0

TYPICAL CHARACTERISTICS

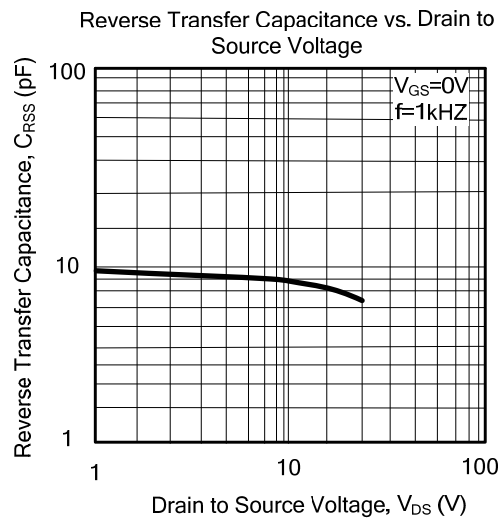
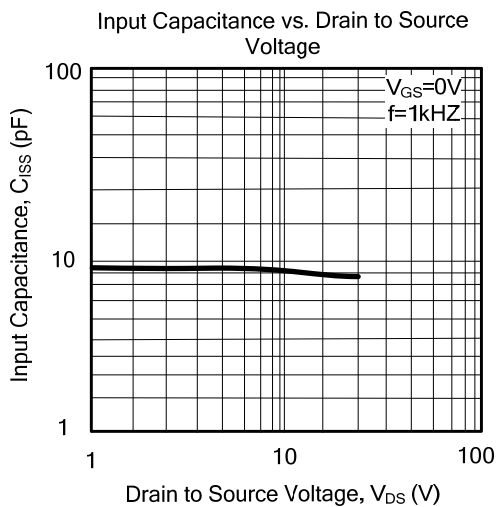
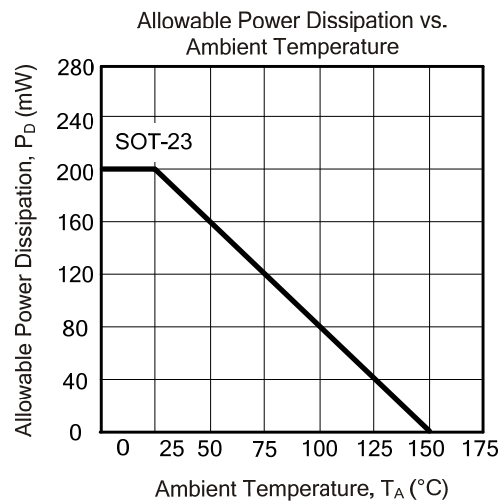
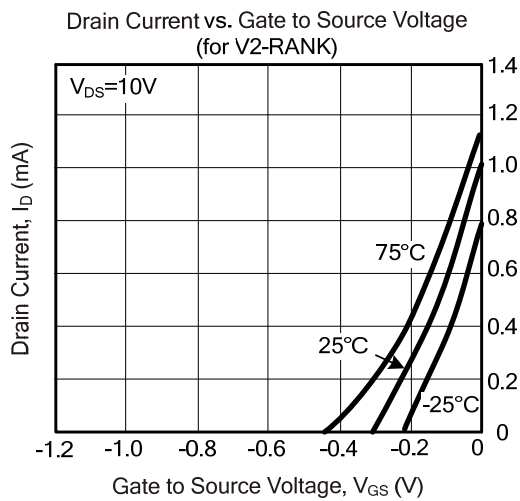
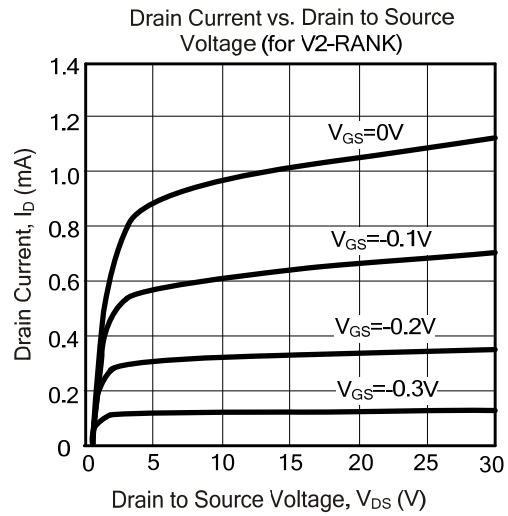
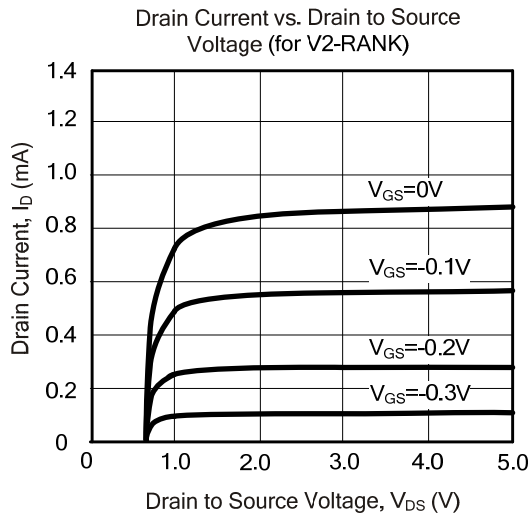

UTC assumes no responsibility for equipment failures that result from using products at values that exceed, even momentarily, rated values (such as maximum ratings, operating condition ranges, or other parameters) listed in products specifications of any and all UTC products described or contained herein. UTC products are not designed for use in life support appliances, devices or systems where malfunction of these products can be reasonably expected to result in personal injury. Reproduction in whole or in part is prohibited without the prior written consent of the copyright owner. UTC reserves the right to make changes to information published in this document, including without limitation specifications and product descriptions, at any time and without notice. This document supersedes and replaces all information supplied prior to the publication hereof.