



2W005M thru 2W10M / 2W005G thru 2W10G

Glass Passivated Single-Phase Bridge Rectifiers
Reverse Voltage 50 to 1000 Volts Forward Current 2.0 Amperes

Features

- ◆ Ideal for printed circuit boards
- ◆ Typical I_r less than 0.5 μ A
- ◆ High case dielectric strength
- ◆ High surge current capability
- ◆ Solder Dip 260 °C, 40 seconds

Mechanical Data

- ◆ Case: WOB / WOG
Epoxy meets UL-94V-0 Flammability rating
- ◆ Terminals: Silver plated (E4 Suffix) leads, solderable per J-STD-002B and JESD22-B102D
- ◆ Polarity: As marked on body

Typical Applications

General purpose use in ac-to-dc bridge full wave rectification for Power Supply, Adapter, Charger, lighting Ballaster on Consumers and Home Appliances applications

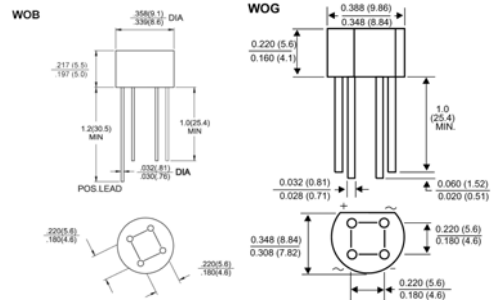
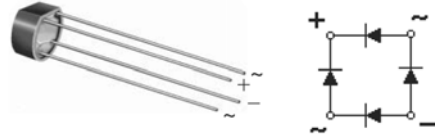
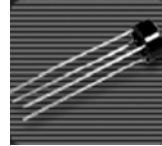

Package outline dimensions in inches (millimeters)

Maximum Ratings and Electrical Characteristics

Rating at 25°C ambient temperature unless otherwise specified.

Parameter	Symbols	2W005M	2W01M	2W02M	2W04M	2W06M	2W08M	2W10M	Units
		2W005G	2W01G	2W02G	2W04G	2W06G	2W08G	2W10G	
Maximum recurrent peak reverse voltage	V_{RRM}	50	100	200	400	600	800	1000	Volts
Maximum RMS voltage	V_{RMS}	35	70	140	280	420	560	700	Volts
Maximum DC blocking voltage	V_{DC}	50	100	200	400	600	800	1000	Volts
Maximum average forward rectified current 0.375" (9.5mm) lead length (See Fig.2 and Fig.1)	$I_{F(AV)}$	2.0							Amps
Peak forward surge current, 8.3ms single half sine-wave superimposed on rated load (JEDEC Method)	I_{FSM}	2W005M: 50.0, 2W005G: 60.0							Amps
Rating for fusing (t < 8.3ms)	I^2t	2W005G: 15.0							A ² sec
Max. instantaneous forward voltage drop per element at 1.0A	V_F	1.1							Volts
Maximum DC reverse current $T_A=25^\circ\text{C}$ at rated DC blocking voltage per element	I_R	10.0 500 (2W005M @ $T_A=100^\circ\text{C}$, 2W005G @ $T_A=125^\circ\text{C}$)							μ A
Typical junction capacitance per element (Note 1)	C_j	40				20			pF
Typical thermal resistance per leg (Note 2)	$R_{\theta JA}$ $R_{\theta JL}$	40 15							°C/W
Operating temperature range	T_J	2W005M: -55 to +125 2W005G: -55 to +150							°C
Storage temperature range	T_{STG}	-55 to +150							°C

- Notes:**
1. Measured at 1.0MHz and applied reverse voltage of 4.0 volts
 2. Thermal resistance from junction to ambient and from junction to lead at 0.375" (9.5 mm) lead length P.C.B. mounting

RATINGS AND CHARACTERISTIC CURVES

($T_A = 25^\circ\text{C}$ unless otherwise noted) - 2W005M thru 2W10M

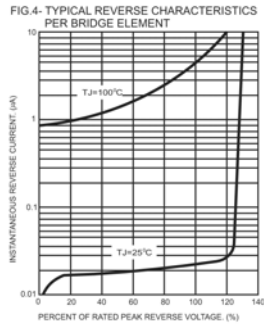
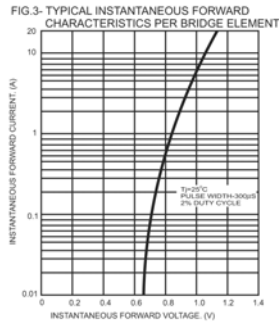
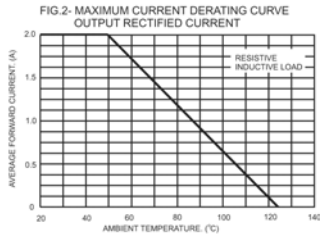
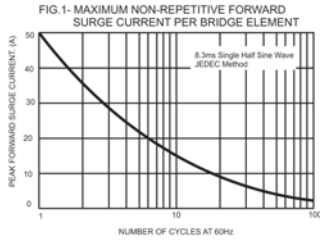

($T_A = 25^\circ\text{C}$ unless otherwise noted) - 2W005G thru 2W10G

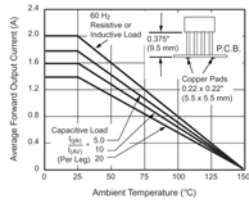

Figure 1. Derating Curve Output Rectified Current

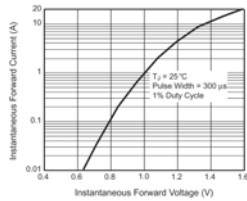

Figure 3. Typical Forward Characteristics Per Leg

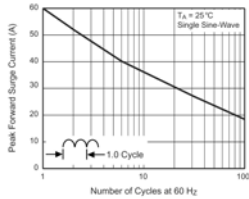

Figure 2. Maximum Non-Repetitive Peak Forward Surge Current Per Leg

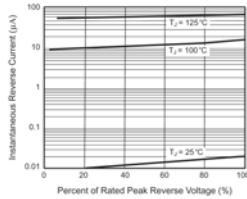

Figure 4. Typical Reverse Leakage Characteristics Per Leg

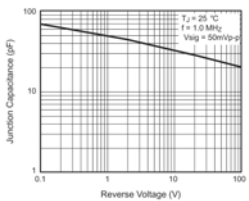

Figure 5. Typical Junction Capacitance Per Leg

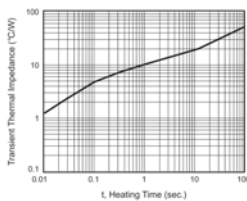

Figure 6. Typical Transient Thermal Impedance