

SEMICONDUCTOR GENERAL CATALOG

Transistors

Bipolar Small-Signal Transistors
Junction FETs
Combination Products of Different Type Devices
MOSFETs
Bipolar Power Transistors
Radio-Frequency Bipolar Small-Signal Transistors
Radio-Frequency Small-Signal FETs
Radio-Frequency Power MOSFETs
IGBTs
Phototransistors (for Optical Sensors)

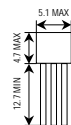

Bipolar Small-Signal Transistors

General-Purpose Transistors (Leaded Type)

Classification	V _{CE0} (V) Max	I _c (A) Max	h _{FE}	V _{CE(sat)} (V) Max	Package	
					TO-92 (SC-43)	
						
					NPN	PNP
General-purpose	50	0.15	70 to 700	0.25	2SC1815	
	-50	-0.15	70 to 400	-0.3		2SA1015
	120	0.1	200 to 700	0.3	2SC2240	
	-120	-0.1	200 to 700	-0.3		2SA970
Low noise	50	0.15	70 to 700	0.25	2SC1815(L)	
	-50	-0.15	70 to 400	-0.3		2SA1015(L)
	50	0.15	200 to 700	0.3	2SC732TM	—
	30	0.5	70 to 400	0.25	2SC1959	
Audio drivers	-30	-0.5	70 to 240	-0.25		2SA562TM
	80	0.3	70 to 240	0.5	2SC1627	
	-80	-0.3	70 to 240	-0.4		2SA817
	30	0.8	100 to 320	0.5	2SC2120	
High current	-30	-0.8	100 to 320	-0.7		2SA950
	20	2	120 to 700	0.5	2SC3266	
	-20	-2	120 to 400	-0.5		2SA1296
	10	2	140 to 600	0.5	2SC3279	
	-10	-2	140 to 600	-0.5		2SA1300
	10	5	700 to 2000	0.25	2SC5853	—
	10	5	450 to 700	0.27	2SC5854	—
	10	5	450 to 700	0.3	—	—
	80	1.2	100 to 200	0.09	2SC6132	—
Darlington	40	0.3	10000 min	1.3	2SC982TM	—
Muting	20	0.3	200 to 1200	0.1	2SC2878	—
High breakdown voltage	300	0.1	30 to 150	0.5	2SC2551	
	-300	-0.1	30 to 150	-0.5		2SA1091
	250	0.05	50 min	1.5	2SC3333	
	-250	-0.05	50 min	-1.5		2SA1320
High-speed switching	15	0.2	40 to 240	0.3	2SC752(G)TM	—
High h _{FE}	50	0.15	600 to 3600	0.25	2SC3112	—

- The products shown in bold are also manufactured in offshore fabs.
- Contact the Toshiba sales representative for information about RoHS compliance before you purchase any components.

General-Purpose Transistors (Single)

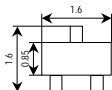
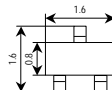
Classification	V _{CEO} (V) Max	I _C (mA) Max	(Surface-Mount Type)									
			CST3		fSM		VESM		ESM		SSM	
												
(mm)		(mm)		(mm)		(mm)		(mm)				
			NPN	PNP	NPN	PNP	NPN	PNP	NPN	PNP	NPN	PNP
General-purpose	50	100	2SC6026CT	2SA2154CT	2SC6026	2SA2154						
		150					2SC6026MFV	2SA2154MFV	2SC4738F	2SA1832F	2SC4738	2SA1832
	30	500										
	50	500										
Low noise	120	100										
High current	12	400	2SC5376CT	2SA1955CT			2SC5376FV	2SA1955FV	2SC5376F	2SA1955F	2SC5376	2SA1955
	12	500										
	15	800										
	25	800										
	30	800										
	10	2000										
	20	2000										
	20	1500										
	20	2500										
	30	3000										
	50	1000										
	50	1700										
50	2500											
Strobe	10	5000 (3000)										
High breakdown voltage	80	300										
High h _{FE}	50	150										
Muting	20	300										
High-speed switching	15	200										
High-voltage switching	200	50										
High breakdown voltage	250	50										
	300	100										
Darlington	40	300										

- For the PNP transistors, the minus sign (-) indicating a negative voltage is omitted.
- The products shown in bold are also manufactured in offshore fabs.
- Contact the Toshiba sales representative for information about RoHS compliance before you purchase any components.

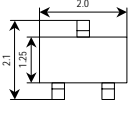
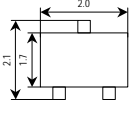
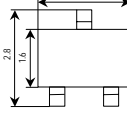
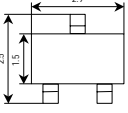
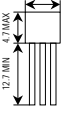
								Leaded Type	
USM  (mm)		UFM  (mm)		TSM  (mm)		S-MINI  (mm)		TO-92  (mm)	
NPN	PNP	NPN	PNP	NPN	PNP	NPN	PNP	NPN	PNP
2SC4116	2SA1586					2SC2712	2SA1162	2SC1815	2SA1015
TTC4116FU *	TTA1586FU *								
2SC4118	2SA1588					2SC2859	2SA1182	2SC1959	2SA562TM
						2SC3325	2SA1313		
2SC4117	2SA1587					2SC2713	2SA1163	2SC2240	2SA970
						2SC3324	2SA1312		
2SC5233	2SA1954					2SC5232	2SA1953		
							2SA1362		
						2SC3265	2SA1298		
						2SC4210	2SA1621	2SC2120	2SA950
								2SC3279	2SA1300
								2SC3266	2SA1296
		2SC6133 *	2SA2214 *						
			2SA2215 *						
		2SC6134 *							
		2SC6135 *							
			2SA2195 *						
		2SC6100 *							
				(2SC5766)				2SC5853	
								2SC5471	
								2SC5854	
								2SC6067	
						2SC4209	2SA1620	2SC1627	2SA817
2SC4666						2SC3295		2SC3112	
2SC4213						2SC3326		2SC2878	
2SC4667						2SC3437		2SC752(G)TM	
						2SC3138	2SA1255		
								2SC3333	2SA1320
						2SC4497	2SA1721	2SC2551	2SA1091
						2SC2532		2SC982TM	

*: New product

General-Purpose Transistors (Dual)

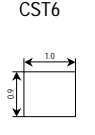
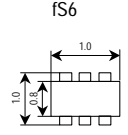
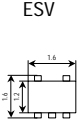
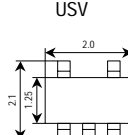
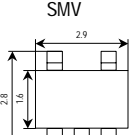
Classification	V _{CE0} (V) Max	I _c (mA) Max	Dual Type									
			CST6  (mm)	fs6  (mm)		ESV  (mm)	USV  (mm)		SMV  (mm)			
			NPN + PNP	NPN	PNP	NPN + PNP	PNP + NPN	NPN	PNP	NPN	PNP	PNP + NPN
General-purpose	50	150 (100)	(HN2B26CT) (▲18) **	(HN1C26FS) (▲10) (HN2C26FS) (▲12)	(HN1A26FS) (▲7) (HN2A26FS) (▲11)	(HN1B26FS) (▲9)	HN4B01JE (▲6)	2SC4944 (▲2)	2SA1873 (▲1) HN4A56JU (▲4)	2SC4207 (▲2)	2SA1618 (▲1)	
	30	500										HN4B04J (▲3) *
	50	500										
Low noise	120	100								HN4C06J (▲2) HN4C51J (▲5)	HN4A06J (▲1) HN4A51J (▲4)	HN4B06J (▲3)
High current	12	400						HN4C05JU (▲2)				
	12	500										
	15	800										
	25	800								HN4C08J (▲2)	HN4A08J (▲1)	
	30	800										
	10	2000										
20	2000											
Strobe	10	5000										
High breakdown voltage	80	300										
High h _{FE}	50	150										
Muting	20	300										
High-speed switching	15	200										
High-voltage switching	200	50										
High breakdown voltage	250	50										
	300	100										
Darlington	40	300										

- For the PNP transistors, the minus sign (-) indicating a negative voltage is omitted.
- The ratings enclosed in parenthesis are for those devices whose part numbers are enclosed in parentheses.
- The products shown in bold are also manufactured in offshore fabs.
- Contact the Toshiba sales representative for information about RoHS compliance before you purchase any components.

◆Internal Connections

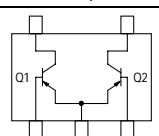
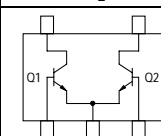
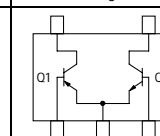
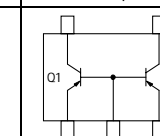
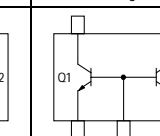
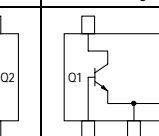
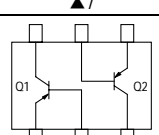
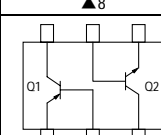
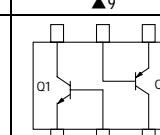
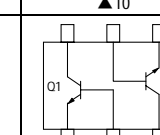
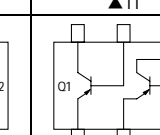
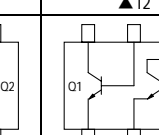
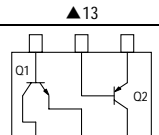
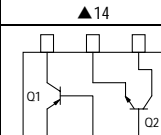
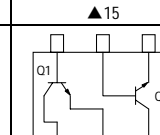
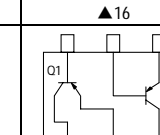
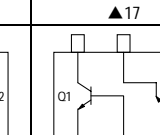
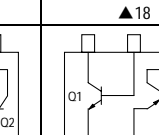
Number of Pins	▲1	▲2	▲3	▲4	▲5	▲6
5						
6	▲7	▲8	▲9	▲10	▲11	▲12
						
6	▲13	▲14	▲15	▲16	▲17	▲18
						

◆The internal connection diagrams only show the general configurations of the circuits.

Bias Resistor Built-in Transistors (Single, General-Purpose)

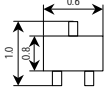
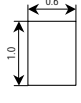
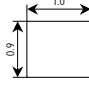
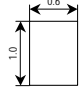
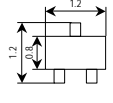
Ratings		20						50					
		50						100					
Internal Resistors (kΩ)		ISM 		CST3 		CST6 		CST3 		VESM 			
R1	R2	NPN		PNP		NPN + PNP		NPN		PNP			
4.7	4.7	RN1101FS	RN2101FS	RN1101CT	RN2101CT	RN1961CT	RN2961CT		RN1101ACT	RN2101ACT	RN1101MFV	RN2101MFV	
10	10	RN1102FS	RN2102FS	RN1102CT	RN2102CT	RN1962CT	RN2962CT		RN1102ACT	RN2102ACT	RN1102MFV	RN2102MFV	
22	22	RN1103FS	RN2103FS	RN1103CT	RN2103CT	RN1963CT	RN2963CT		RN1103ACT	RN2103ACT	RN1103MFV	RN2103MFV	
47	47	RN1104FS	RN2104FS	RN1104CT	RN2104CT	RN1964CT	RN2964CT		RN1104ACT	RN2104ACT	RN1104MFV	RN2104MFV	
2.2	47	RN1105FS	RN2105FS	RN1105CT	RN2105CT	RN1965CT	RN2965CT		RN1105ACT	RN2105ACT	RN1105MFV	RN2105MFV	
4.7	47	RN1106FS	RN2106FS	RN1106CT	RN2106CT	RN1966CT	RN2966CT	RN49P2ACT	RN1106ACT	RN2106ACT	RN1106MFV	RN2106MFV	
10	47	RN1107FS	RN2107FS	RN1107CT	RN2107CT	RN1967CT	RN2967CT		RN1107ACT	RN2107ACT	RN1107MFV	RN2107MFV	
22	47	RN1108FS	RN2108FS	RN1108CT	RN2108CT	RN1968CT	RN2968CT		RN1108ACT	RN2108ACT	RN1108MFV	RN2108MFV	
47	22	RN1109FS	RN2109FS	RN1109CT	RN2109CT	RN1969CT	RN2969CT		RN1109ACT	RN2109ACT	RN1109MFV	RN2109MFV	
4.7	∞	RN1110FS	RN2110FS	RN1110CT	RN2110CT	RN1970CT	RN2970CT		RN1110ACT	RN2110ACT	RN1110MFV	RN2110MFV	
10	∞	RN1111FS	RN2111FS	RN1111CT	RN2111CT	RN1971CT	RN2971CT		RN1111ACT	RN2111ACT	RN1111MFV	RN2111MFV	
22	∞	RN1112FS	RN2112FS	RN1112CT	RN2112CT	RN1972CT	RN2972CT		RN1112ACT	RN2112ACT	RN1112MFV	RN2112MFV	
47	∞	RN1113FS	RN2113FS	RN1113CT	RN2113CT	RN1973CT	RN2973CT		RN1113ACT	RN2113ACT	RN1113MFV	RN2113MFV	
1	10										RN1114MFV	RN2114MFV	
2.2	10										RN1115MFV	RN2115MFV	
4.7	10										RN1116MFV	RN2116MFV	
10	4.7										RN1117MFV	RN2117MFV	
47	10										RN1118MFV	RN2118MFV	
1	—										RN1119MFV	RN2119MFV	
100	100										RN1130MFV	RN2130MFV	
100	∞										RN1131MFV	RN2131MFV	
200	∞										RN1132MFV	RN2132MFV	

- For the PNP transistors, the minus sign (-) indicating a negative voltage is omitted.
- The products shown in bold are also manufactured in offshore fabs.
- Contact the Toshiba sales representative for information about RoHS compliance before you purchase any components.

(Single, High-Current/Muting Switch)

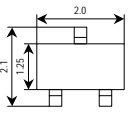
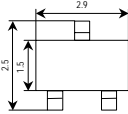
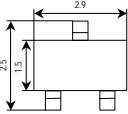
Ratings		High Current				Muting	
		12		50		20	
		500		800		300	
Internal Resistors (kΩ)		USM 		S-MINI 		S-MINI 	
R1	R2	NPN		PNP		NPN	
1	1	RN1321A		RN2321A		RN1421	RN2421
2.2	2.2	RN1322A		RN2322A		RN1422	RN2422
4.7	4.7	RN1323A		RN2323A		RN1423	RN2423
10	10	RN1324A		RN2324A		RN1424	RN2424
0.47	10	RN1325A		RN2325A		RN1425	RN2425
1	10	RN1326A		RN2326A		RN1426	RN2426
2.2	10	RN1327A		RN2327A		RN1427	RN2427
5.6	∞						RN1441
10	∞						RN1442
22	∞						RN1443
2.2	∞						RN1444

- For the PNP transistors, the minus sign (-) indicating a negative voltage is omitted.
- Contact the Toshiba sales representative for information about RoHS compliance before you purchase any components.

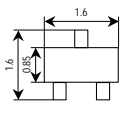
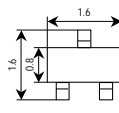
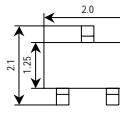
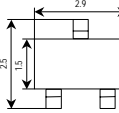
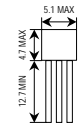
50									
100									
ESM		SSM		USM		S-MINI		TO-92	
									
NPN	PNP	NPN	PNP	NPN	PNP	NPN	PNP	NPN	PNP
RN1101F	RN2101F	RN1101	RN2101	RN1301	RN2301	RN1401	RN2401	RN1001	RN2001
RN1102F	RN2102F	RN1102	RN2102	RN1302	RN2302	RN1402	RN2402	RN1002	RN2002
RN1103F	RN2103F	RN1103	RN2103	RN1303	RN2303	RN1403	RN2403	RN1003	RN2003
RN1104F	RN2104F	RN1104	RN2104	RN1304	RN2304	RN1404	RN2404	RN1004	RN2004
RN1105F	RN2105F	RN1105	RN2105	RN1305	RN2305	RN1405	RN2405	RN1005	RN2005
RN1106F	RN2106F	RN1106	RN2106	RN1306	RN2306	RN1406	RN2406	RN1006	RN2006
RN1107F	RN2107F	RN1107	RN2107	RN1307	RN2307	RN1407	RN2407	RN1007	RN2007
RN1108F	RN2108F	RN1108	RN2108	RN1308	RN2308	RN1408	RN2408	RN1008	RN2008
RN1109F	RN2109F	RN1109	RN2109	RN1309	RN2309	RN1409	RN2409	RN1009	RN2009
RN1110F	RN2110F	RN1110	RN2110	RN1310	RN2310	RN1410	RN2410	RN1010	RN2010
RN1111F	RN2111F	RN1111	RN2111	RN1311	RN2311	RN1411	RN2411	RN1011	RN2011
RN1112F	RN2112F	RN1112	RN2112	RN1312	RN2312	RN1412	RN2412		
RN1113F	RN2113F	RN1113	RN2113	RN1313	RN2313	RN1413	RN2413		
RN1114F	RN2114F	RN1114	RN2114	RN1314	RN2314	RN1414	RN2414		
RN1115F	RN2115F	RN1115	RN2115	RN1315	RN2315	RN1415	RN2415		
RN1116F	RN2116F	RN1116	RN2116	RN1316	RN2316	RN1416	RN2416		
RN1117F	RN2117F	RN1117	RN2117	RN1317	RN2317	RN1417	RN2417		
RN1118F	RN2118F	RN1118	RN2118	RN1318	RN2318	RN1418	RN2418		
RN1130F	RN2130F								
RN1131F	RN2131F								
RN1132F	RN2132F								

Bias Resistor Built-in Transistors (Dual, General-Purpose (5 Pin))

Classification	Absolute Maximum Ratings		Internal Resistors				ESV			USV			
	V _{CEO} (V)	I _C (mA)	Q1		Q2								
			(kΩ)		(kΩ)								
			R1	R2	R1	R2							
						Common emitter	Common emitter	Collector-base connection	Common emitter	Common emitter	Collector-base connection		
General-purpose	50	100	4.7	4.7	4.7	4.7	RN1701JE	RN2701JE		RN1701	RN2701		
			10	10	10	10	RN1702JE	RN2702JE	RN47A3JE	RN1702	RN2702	RN47A3	
			22	22	22	22	RN1703JE	RN2703JE	RN47A2JE	RN1703	RN2703	RN47A2	
			47	47	47	47	RN1704JE	RN2704JE		RN1704	RN2704		
			2.2	47	2.2	47	RN1705JE	RN2705JE		RN1705	RN2705		
			4.7	47	4.7	47	RN1706JE	RN2706JE		RN1706	RN2706		
			10	47	10	47	RN1707JE	RN2707JE		RN1707	RN2707		
			22	47	22	47	RN1708JE	RN2708JE		RN1708	RN2708		
			47	22	47	22	RN1709JE	RN2709JE		RN1709	RN2709		
			4.7	—	4.7	—	RN1710JE	RN2710JE	RN47A1JE	RN1710	RN2710	RN47A1	
			10	—	10	—	RN1711JE	RN2711JE		RN1711	RN2711		
			22	—	22	—		RN2712JE					
			47	—	47	—		RN2713JE					
			1	10	1	10					RN2714		
			2.2	10	2.2	10							
			4.7	10	4.7	10							
			10	4.7	10	4.7							
			47	10	47	10							
			47	47	10	47				RN47A4JE			RN47A4
			47	47	4.7	10				RN47A5JE			RN47A5
100	100	100	100							RN47A6			
10	10	47	10							RN47A7			
	Q1: 50	Q1: 100											
	Q2: 12	Q2: 100 (Lowsat)	10	10	4.7	10				RN47A7JE			
	Q1: 50	Q1: 100											
	Q2: 30	Q2: 100 (High hFE)	10	10	10	47				RN47A8JE			
Muting	20	300	2.2	—	2.2	—							

- For the PNP transistors, the minus sign (-) indicating a negative voltage is omitted.
- The products shown in bold are also manufactured in offshore fabs.
- Contact the Toshiba sales representative for information about RoHS compliance before you purchase any components.

(Dual, General-Purpose (6 Pin))

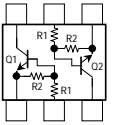
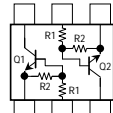
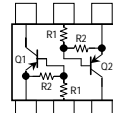
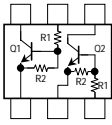
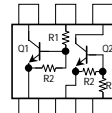
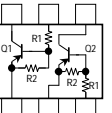
FS6																	
																	
Classification	Absolute Maximum Ratings		Internal Resistors				NPN	PNP	PNP + NPN	Absolute Maximum Ratings		Internal Resistors		NPN x 2	PNP x 2		
	V _{CEO} (V)	I _c (mA)	Q1 (kΩ)		Q2 (kΩ)					V _{CEO} (V)	I _c (mA)	Q1 (kΩ)		Q2 (kΩ)			
			R1	R2	R1	R2						R1	R2	R1	R2		
General-purpose	50	80	4.7	4.7	4.7	4.7	RN1901AFS	RN2901AFS	RN4981AFS	20	50	4.7	4.7	4.7	4.7	RN1961FS	RN2961FS
			10	10	10	10	RN1902AFS	RN2902AFS	RN4982AFS			10	10	10	10	RN1962FS	RN2962FS
			22	22	22	22	RN1903AFS	RN2903AFS	RN4983AFS			22	22	22	22	RN1963FS	RN2963FS
			47	47	47	47	RN1904AFS	RN2904AFS	RN4984AFS			47	47	47	47	RN1964FS	RN2964FS
			2.2	47	2.2	47	RN1905AFS	RN2905AFS	RN4985AFS			2.2	47	2.2	47	RN1965FS	RN2965FS
			4.7	47	4.7	47	RN1906AFS	RN2906AFS	RN4986AFS			4.7	47	4.7	47	RN1966FS	RN2966FS
			10	47	10	47	RN1907AFS	RN2907AFS	RN4987AFS			10	47	10	47	RN1967FS	RN2967FS
			22	47	22	47	RN1908AFS	RN2908AFS	RN4988AFS			22	47	22	47	RN1968FS	RN2968FS
			47	22	47	22	RN1909AFS	RN2909AFS	RN4989AFS			47	22	47	22	RN1969FS	RN2969FS
			4.7	—	4.7	—	RN1910AFS	RN2910AFS	RN4990AFS			4.7	—	4.7	—	RN1970FS	RN2970FS
			10	—	10	—	RN1911AFS	RN2911AFS	RN4991AFS			10	—	10	—	RN1971FS	RN2971FS
			22	—	22	—	RN1912AFS	RN2912AFS	RN4992AFS			22	—	22	—	RN1972FS	RN2972FS
			47	—	47	—	RN1913AFS	RN2913AFS	RN4993AFS			47	—	47	—	RN1973FS	RN2973FS
			1	10	1	10						1	10	1	10		
			2.2	10	2.2	10						2.2	10	2.2	10		
			4.7	10	4.7	10						4.7	10	4.7	10		
			10	4.7	10	4.7						10	4.7	10	4.7		
			47	10	47	10						47	10	47	10		
			2.2	47	22	47						2.2	47	22	47		
			2.2	47	47	47						2.2	47	47	47		
22	22	10	10				22	22	10	10							
10	10	10	—				10	10	10	—							
47	47	4.7	47				47	47	4.7	47							
General-purpose (Hiβ)	40 (-30)	100	4.7	—	4.7	—				40 (-30)	100	4.7	—	4.7	—		
			10	—	10	—						10	—	10	—		
			22	—	22	—						22	—	22	—		
Power SW	50 (-12)	100 (-500)	10	47	2.0	10				50 (-12)	100 (-500)	10	47	2.0	10		

- For the PNP transistors, the minus sign (-) indicating a negative voltage is omitted.
- Contact the Toshiba sales representative for information about RoHS compliance before you purchase any components.

(mm)

NPN x 2	PNP x 2	NPN + PNP	NPN + PNP	NPN + PNP	NPN + PNP	Absolute Maximum Ratings	Internal Resistors	NPN + PNP				
						V _{CEO} (V)	I _c (mA)	Q1 (kΩ) R1 R2	Q2 (kΩ) R1 R2			
RN1901FS	RN2901FS	RN4981FS				50	50	4.7	4.7	4.7	4.7	
RN1902FS	RN2902FS	RN4982FS						10	10	10	10	
RN1903FS	RN2903FS	RN4983FS						22	22	22	22	
RN1904FS	RN2904FS	RN4984FS		RN49J2FS	RN49J7FS			47	47	47	47	RN49J2AFS
RN1905FS	RN2905FS	RN4985FS						2.2	47	2.2	47	
RN1906FS	RN2906FS	RN4986FS						4.7	47	4.7	47	
RN1907FS	RN2907FS	RN4987FS						10	47	10	47	
RN1908FS	RN2908FS	RN4988FS						22	47	22	47	
RN1909FS	RN2909FS	RN4989FS						47	22	47	22	
RN1910FS	RN2910FS	RN4990FS						4.7	—	4.7	—	
RN1911FS	RN2911FS	RN4991FS						10	—	10	—	
RN1912FS	RN2912FS	RN4992FS						22	—	22	—	
RN1913FS	RN2913FS	RN4993FS						47	—	47	—	
						1	10	1	10			
						2.2	10	2.2	10			
						4.7	10	4.7	10			
						10	4.7	10	4.7			
						47	10	47	10			
						2.2	47	22	47			
						2.2	47	47	47			
						22	22	10	10			
			RN49P1FS			10	10	10	—			
		RN49A6FS				47	47	4.7	47			
						4.7	—	4.7	—			
						40 (-30)	100	10	—	10	—	
						50 (-12)	100 (-500)	22	—	22	—	
								10	47	2.0	10	

The internal connection diagrams only show the general configurations of the circuits.

(Dual, General-Purpose (6 Pin)) (Continued)

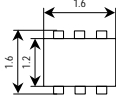
Classification	Absolute Maximum Ratings		Internal Resistors				ES6						
	V _{CE0} (V)	I _C (mA)	Q1		Q2		 (mm)						
			(kΩ)		(kΩ)								
			R1	R2	R1	R2	NPN x 2	PNP x 2	NPN x 2	PNP x 2	PNP + NPN	NPN + PNP	NPN + PNP
General-purpose	50	100	4.7	4.7	4.7	4.7	RN1901FE	RN2901FE	RN1961FE	RN2961FE	RN4901FE	RN4981FE	
			10	10	10	10	RN1902FE	RN2902FE	RN1962FE	RN2962FE	RN4902FE	RN4982FE	RN4962FE
			22	22	22	22	RN1903FE	RN2903FE	RN1963FE	RN2963FE	RN4903FE	RN4983FE	
			47	47	47	47	RN1904FE	RN2904FE	RN1964FE	RN2964FE	RN4904FE	RN4984FE	
			2.2	47	2.2	47	RN1905FE	RN2905FE	RN1965FE	RN2965FE	RN4905FE	RN4985FE	
			4.7	47	4.7	47	RN1906FE	RN2906FE	RN1966FE	RN2966FE	RN4906FE	RN4986FE	
			10	47	10	47	RN1907FE	RN2907FE	RN1967FE	RN2967FE	RN4907FE	RN4987FE	
			22	47	22	47	RN1908FE	RN2908FE	RN1968FE	RN2968FE	RN4908FE	RN4988FE	
			47	22	47	22	RN1909FE	RN2909FE	RN1969FE	RN2969FE	RN4909FE	RN4989FE	
			4.7	—	4.7	—	RN1910FE	RN2910FE	RN1970FE	RN2970FE	RN4910FE	RN4990FE	
			10	—	10	—	RN1911FE	RN2911FE	RN1971FE	RN2971FE	RN4911FE	RN4991FE	
			22	—	22	—							
			47	—	47	—							
			1	10	1	10							
			2.2	10	2.2	10							
			4.7	10	4.7	10							
			10	4.7	10	4.7							
			47	10	47	10							
			2.2	47	22	47					RN49A1FE		
			2.2	47	47	47							
22	22	10	10										
10	10	10	—										
General-purpose (H _{ij})	40 (-30)	100	4.7	—	4.7	—			RN1970HFE	RN2970HFE		RN4990HFE	
			10	—	10	—			RN1971HFE	RN2971HFE		RN4991HFE	
			22	—	22	—			RN1972HFE	RN2972HFE		RN4992HFE	
Power SW	50 (-12)	100 (-500)	10	47	2.0	10							

- For the PNP transistors, the minus sign (-) indicating a negative voltage is omitted.
- Contact the Toshiba sales representative for information about RoHS compliance before you purchase any components.

The internal connection diagrams only show the general configurations of the circuits.

Classification	Absolute Maximum Ratings		Internal Resistors				US6					
	V _{CEO} (V)	I _C (mA)	Q1		Q2		 (mm)					
			(kΩ)		(kΩ)							
			R1	R2	R1	R2	NPN x 2	PNP x 2	NPN x 2	PNP x 2	PNP + NPN	NPN + PNP
General-purpose	50	100	4.7	4.7	4.7	4.7	RN1901	RN2901	RN1961	RN2961	RN4901	RN4981
			10	10	10	10	RN1902	RN2902	RN1962	RN2962	RN4902	RN4982
			22	22	22	22	RN1903	RN2903	RN1963	RN2963	RN4903	RN4983
			47	47	47	47	RN1904	RN2904	RN1964	RN2964	RN4904	RN4984
			2.2	47	2.2	47	RN1905	RN2905	RN1965	RN2965	RN4905	RN4985
			4.7	47	4.7	47	RN1906	RN2906	RN1966	RN2966	RN4906	RN4986
			10	47	10	47	RN1907	RN2907	RN1967	RN2967	RN4907	RN4987
			22	47	22	47	RN1908	RN2908	RN1968	RN2968	RN4908	RN4988
			47	22	47	22	RN1909	RN2909	RN1969	RN2969	RN4909	RN4989
			4.7	—	4.7	—	RN1910	RN2910	RN1970	RN2970	RN4910	RN4990
			10	—	10	—	RN1911	RN2911	RN1971	RN2971	RN4911	RN4991
			22	—	22	—						
			47	—	47	—			RN1973			
			1	10	1	10						
			2.2	10	2.2	10				RN2975		
			4.7	10	4.7	10						
			10	4.7	10	4.7						
			47	10	47	10						
			2.2	47	22	47					RN49A1	
			2.2	47	47	47					RN49A2	
22	22	10	10									
10	10	10	—									
General-purpose (Hiβ)	40 (-30)	100	4.7	—	4.7	—						
			10	—	10	—						
			22	—	22	—						
Power SW	50 (-12)	100 (-500)	10	47	2.0	10					RN49A5	

- For the PNP transistors, the minus sign (-) indicating a negative voltage is omitted.
- The products shown in bold are also manufactured in offshore fabs.
- Contact the Toshiba sales representative for information about RoHS compliance before you purchase any components.

The internal connection diagrams only show the general configurations of the circuits.

(Dual, General-Purpose (6 Pin)) (Continued)

Classification	Absolute Maximum Ratings		Internal Resistors				SM6			
	V _{CEO} (V)	I _C (mA)	Q1		Q2		 (mm)			
			(kΩ)		(kΩ)					
			R1	R2	R1	R2	NPN x 2	PNP x 2	NPN x 2	PNP + NPN
General-purpose	50	100	4.7	4.7	4.7	4.7	RN1601	RN2601		RN4601
			10	10	10	10	RN1602	RN2602		RN4602
			22	22	22	22	RN1603	RN2603		RN4603
			47	47	47	47	RN1604	RN2604		RN4604
			2.2	47	2.2	47	RN1605	RN2605		RN4605
			4.7	47	4.7	47	RN1606	RN2606		RN4606
			10	47	10	47	RN1607	RN2607		RN4607
			22	47	22	47	RN1608	RN2608		RN4608
			47	22	47	22	RN1609	RN2609		RN4609
			4.7	—	4.7	—	RN1610	RN2610		RN4610
			10	—	10	—	RN1611	RN2611		RN4611
			22	—	22	—				RN4612
			47	—	47	—			RN1673	
			1	10	1	10				
			2.2	10	2.2	10				
			4.7	10	4.7	10				
			10	4.7	10	4.7				
			47	10	47	10				
			2.2	47	22	47				
			2.2	47	47	47				
22	22	10	10				RN46A1			
10	10	10	—							
General-purpose (Hiβ)	40 (-30)	100	4.7	—	4.7	—				
			10	—	10	—				
			22	—	22	—				
Power SW	50 (-12)	100 (-500)	10	47	2.0	10				

- For the PNP transistors, the minus sign (-) indicating a negative voltage is omitted.
 - The products shown in bold are also manufactured in offshore fabs.
 - Contact the Toshiba sales representative for information about RoHS compliance before you purchase any components.
- The internal connection diagrams only show the general configurations of the circuits.

Junction FETs

Junction FETs (Leaded Type)

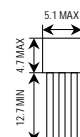
Classification	V _{GDS} (V) Max	I _G (mA) Max	I _{DSS} (mA)	Y _{fs} (mS) Min	Package	
					TO-92 (SC-43)	
					 (mm)	
		Nch	Pch			
General-purpose	-50	10	1.2 to 14	1.5	2SK246	
	50	-10	-1.2 to -14	1		2SJ103
	-50	10	1.2 to 14	4	2SK117	—
	-50	10	1.2 to 14	5	2SK362	—
	-40	10	5 to 30	25	2SK363	—
Low noise	-40	10	2.6 to 20	12	2SK364	
	-50	10	0.3 to 6.5	1.2	2SK30ATM	—
	-40	10	2.6 to 20	—	2SK170	
	-40	10	2.6 to 20	25	2SK369	—

- The products shown in bold are also manufactured in offshore fabs.
- Contact the Toshiba sales representative for information about RoHS compliance before you purchase any components.

(Surface-Mount Type)

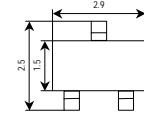
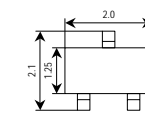
Classification	V _{GDS} (V) Max	I _G (mA) Max	I _{DSS} (mA)	Y _{fs} (mS) Min	Package			
					S-MINI (SC-59)		USM (SC-70)	
					 (mm)		 (mm)	
		Nch	Pch	Nch	Pch			
General-purpose	-50	10	0.3 to 6.5	1.2	2SK208		2SK879	
	50	-10	-1.2 to -14	1		2SJ106		2SJ144
	-50	10	1.2 to 14	4	2SK209	—	2SK880	—

- The products shown in bold are also manufactured in offshore fabs.
- Contact the Toshiba sales representative for information about RoHS compliance before you purchase any components.

(Surface-Mount Type) (Electret Condense Microphone)

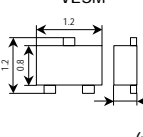
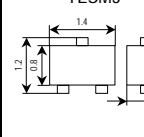
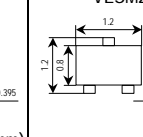
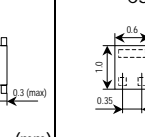
Characteristics	V _{GDS} (V) Max	I _G (mA) Max	I _{DSS} Rank (μ A)	Y _{fs} (mS) Min	C _{iss} (pF) Typ.	Package			
						VESM  (mm)	TESM3  (mm)	VESM2  (mm)	CST3  (mm)
High gain Low THD Low Noise Small C _{iss}	-20	10	A = 80 to 200 B = 170 to 300	0.55	3.6	2SK3582MFV	2SK3582TK	2SK3582TV	2SK3582CT
High gain Low THD Small C _{iss}	-20	10	A = 140 to 240 B = 210 to 350	0.9	3.5	2SK3857MFV	2SK3857TK	2SK3857TV	2SK3857CT
High gain Small C _{iss}	-20	10	A = 140 to 240 AK = 100 to 250 BK = 210 to 400 C = 320 to 500	1.35	4.0	2SK4059MFV	2SK4059TK	2SK4059TV	2SK4059CT
Very Low Noise Very Small C _{iss}	-20	10	A = 140 to 240 B = 210 to 350	0.65	1.8	TTK101MFV *	TTK101TV *	—	—

• Contact the Toshiba sales representative for information about RoHS compliance before you purchase any components.

*: New product

Junction FETs (Dual) (Surface-Mount Type)

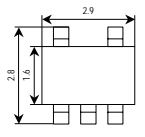
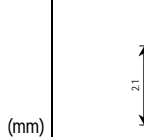
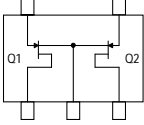
Classification	V _{GDS} (V)	I _G (mA)	I _{DSS} (mA)	Y _{fs} (mS) Min	Package				◆ Internal Connections
					SMV  (mm)		USV  (mm)		
					Nch x 2	Pch x 2	Nch x 2	Pch x 2	
General-purpose	-50	10	1.2 to 14	4	2SK2145	—	2SK3320	—	

• Contact the Toshiba sales representative for information about RoHS compliance before you purchase any components.

◆ The internal connection diagrams only show the general configurations of the circuits.

Combination Products of Different Type Devices

Combination Products of Different Type Devices (5-Pin Packages (UFV, SMV), 6-Pin Packages (ES6, US6, SM6))

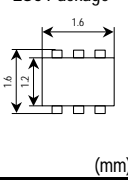
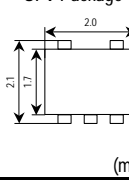
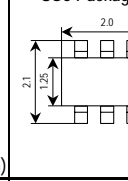
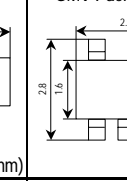
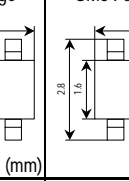
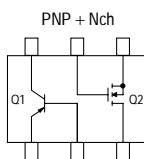
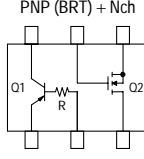
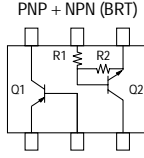
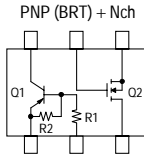
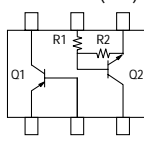
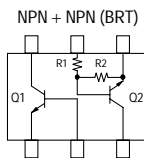
Internal Connections	Part Number					Component Devices	Ratings			Features	
	ES6 Package  (mm)	UFV Package  (mm)	US6 Package  (mm)	SMV Package  (mm)	SM6 Package  (mm)		Breakdown Voltage (V)	Current (mA)			
	—	—	HN7G01FU	—	—	Q1 2SA1955	V _{CEO}	-12	I _c	-400	PNP Low V _{CE(SAT)} , suitable for power supply switches
	—	—	—	—	—	Q2 2SK1829	V _{DS}	20	I _b	50	2.5-V gate drive (V _{th} = 1.5 V max), Ron = 20 Ω typ.
	HN7G01FE	—	—	—	—	Q1 2SA1955	V _{CEO}	-12	I _c	-400	PNP Low V _{CE(SAT)} , suitable for power supply switches
	—	—	—	—	—	Q2 SSM3K03FE	V _{DS}	20	I _b	50	2.5-V gate drive (V _{th} = 1.3 V max), Ron = 4 Ω typ.
	—	—	HN7G02FU	—	—	Q1 RN2310	V _{CEO}	-50	I _c	-100	PNP (Internal resistors), R = 4.7 kΩ
	—	—	—	—	—	Q2 2SK1829	V _{DS}	20	I _b	50	2.5-V gate drive (V _{th} = 1.5 V max), Ron = 20 Ω typ.
	HN7G02FE	—	—	—	—	Q1 RN2310	V _{CEO}	-50	I _c	-100	PNP (Internal resistors), R = 4.7 kΩ
	—	—	—	—	—	Q2 SSM3K03FE	V _{DS}	20	I _b	50	2.5-V gate drive (V _{th} = 1.3 V max), Ron = 4 Ω typ.
	—	—	HN7G04FU	—	—	Q1 2SA1955	V _{CEO}	-12	I _c	-400	PNP Low V _{CE(SAT)} , suitable for power supply switches
	—	—	—	—	—	Q2 RN1307	V _{CEO}	50	I _c	100	NPN (Internal resistors), R1 = 10 kΩ, R2 = 47 kΩ
	—	—	HN7G05FU	—	—	Q1 RN2101	V _{CEO}	-50	I _c	-100	PNP (Internal resistors), R1 = 4.7 kΩ, R2 = 4.7 kΩ
	—	—	—	—	—	Q2 2SK1830	V _{DS}	20	I _b	50	2.5-V gate drive (V _{th} = 1.5 V max), Ron = 20 Ω typ.
	HN7G06FE	—	HN7G06FU	—	—	Q1 2SA1955	V _{CEO}	-12	I _c	-400	PNP Low V _{CE(SAT)} , suitable for power supply switches
	—	—	—	—	—	Q2 RN1104	V _{CEO}	50	I _c	100	NPN (Internal resistors), R1 = 47 kΩ, R2 = 47 kΩ
	HN7G08FE	—	—	—	—	Q1 2SA1955	V _{CEO}	-12	I _c	-400	PNP Low V _{CE(SAT)} , suitable for power supply switches
	—	—	—	—	—	Q2 RN1306	V _{CEO}	50	I _c	100	NPN (Internal resistors), R1 = 4.7 kΩ, R2 = 47 kΩ
	—	—	HN7G07FU	—	—	Q1 2SC5376	V _{CEO}	12	I _c	400	NPN Low V _{CE(SAT)} , suitable for power supply switches
	—	—	—	—	—	Q2 RN1115	V _{CEO}	50	I _c	100	NPN (Internal resistors), R1 = 2.2 kΩ, R2 = 10 kΩ

- The products shown in bold are also manufactured in offshore fabs.
- Contact the Toshiba sales representative for information about RoHS compliance before you purchase any components.

The internal connection diagrams only show the general configurations of the circuits.

Combination Products of Different Type Devices (5-Pin Packages (UFV, SMV), 6-Pin Packages (ES6, US6, SM6)) (Continued)

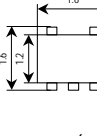
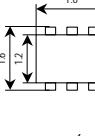
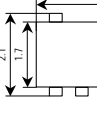
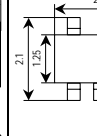
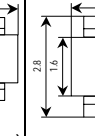
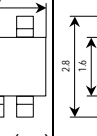
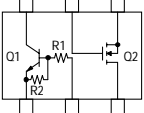
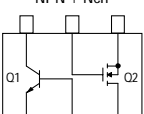
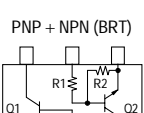
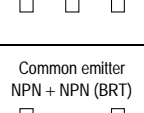
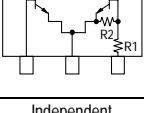
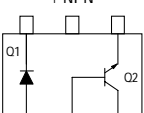
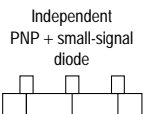
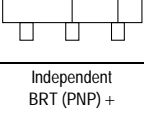
Internal Connections	Part Number						Component Devices	Ratings			Features
	ESV Package  (mm)	ES6 Package  (mm)	UFV Package  (mm)	USV Package  (mm)	SMV Package  (mm)	SM6 Package  (mm)		Breakdown Voltage (V)	Current (mA)		
	—	HN7G09FE	—	—	—	—	Q1 RN1104F	V _{CEO} 50	I _c 100	NPN (Internal resistors), R1 = 47 kΩ, R2 = 47 kΩ	
	—	—	—	—	—	—	Q2 SSM3K15FS	V _{DS} 30	I _o 100	2.5-V gate drive (V _{th} = 1.5 V max), Ron = 4 Ω typ..	
	—	HN7G10FE	—	—	—	—	Q1 2SC5376F	V _{CEO} 12	I _c 400	NPN Low V _{CE(SAT)} , suitable for power supply switches	
	—	—	—	—	—	—	Q2 SSM3K03FE	V _{DS} 20	I _o 50	2.5-V gate drive (V _{th} = 1.3 V max), Ron = 4 Ω typ.	
	—	—	—	—	—	HN7G11F *	Q1 2SA2214	V _{CEO} 20	I _c 1500	PNP, high-current	
	—	—	—	—	—	—	Q2 RN1102	V _{CEO} 100	I _c 100	NPN (Internal resistors), R1 = 10 kΩ, R2 = 10 kΩ	
	—	—	—	—	HN4G01J	—	Q1 2SC4116	V _{CEO} 50	I _c 150	General-purpose NPN transistor	
	—	—	—	—	—	—	Q2 RN1303	V _{CEO} 50	I _c 100	NPN (Internal resistors), R1 = 22 kΩ, R2 = 22 kΩ	
	—	—	—	—	—	HN2E01F	Q1 1SS352	V _R 80	I _o 100	Standard high-speed switching	
	—	—	—	—	—	—	Q2 2SC4666	V _{CEO} 50	I _c 150	High-hFE-type NPN	
	—	—	—	—	—	HN2E02F	Q1 1SS352	V _R 80	I _o 100	Standard high-speed switching	
	—	—	—	—	—	—	Q2 2SC4116	V _{CEO} 50	I _c 150	General-purpose NPN transistor	
	—	—	—	—	—	HN2E04F	Q1 2SA1587	V _{CEO} -120	I _c -100	High breakdown voltage PNP	
	—	—	—	—	—	—	Q2 1SS352	V _R 80	I _o 100	Standard high-speed switching	
	—	—	—	—	HN2E05J	—	Q1 RN2304	V _{CEO} -50	I _c -100	PNP (Internal resistors), R1 = 47 kΩ, R2 = 47 kΩ	
	—	—	—	—	—	—	Q2 1SS352	V _R 80	I _o 100	Standard high-speed switching	
	HN2E07JE	—	—	—	—	—	Q1 1SS417	V _R 40	I _o 100	Schottky barrier diodes	
	—	—	—	—	—	—	Q2 RN2104MFV	V _{CEO} -50	I _c 100	PNP (Internal resistors), R1 = 47 kΩ, R2 = 47 kΩ	

• Contact the Toshiba sales representative for information about RoHS compliance before you purchase any components.

*: New product

The internal connection diagrams only show the general configurations of the circuits.

MOSFETs

Small-Signal MOSFETs (Single-Type)

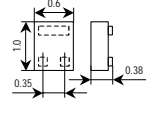
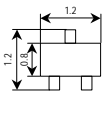
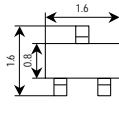
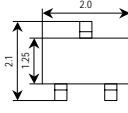
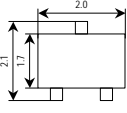
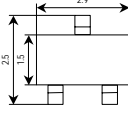
Polarity	Absolute Maximum Ratings			Package					
	V _{DS} (V)	V _{GSS} (V)	I _D (mA)	CST3  (mm)	VESM  (mm)	SSM  (mm)	USM (SC-70)  (mm)	UFM  (mm)	S-MINI (SC-59)  (mm)
N-ch	20	10	100		SSM3K04FV ★	SSM3K04FS ★	SSM3K04FU ★		
	20	±10	250	SSM3K37CT **	SSM3K37MFV *	SSM3K37FS **			
	20	±10	100	SSM3K16CT		SSM3K16FS	SSM3K16FU		
	20	±10	180	SSM3K35CT	SSM3K35MFV	SSM3K35FS			
	20	±10	500		SSM3K36MFV	SSM3K36FS		SSM3K36TU	
	20	±10	500			SSM3K43FS # *			
	30	±20	100	SSM3K15CT	SSM3K15FV	SSM3K15FS	SSM3K15FU		SSM3K15F
	30	±20	100	SSM3K15ACT **	SSM3K15AMFV	SSM3K15AFS	SSM3K15AFU **		
	30	±20	100		SSM3K44MFV # *	SSM3K44FS # *			
	30	±20	200						2SK2009
	30	±20	400				SSM3K09FU		
	50	±7	100				SSM3K17FU		
	60	±20	200				SSM3K7002AFU		SSM3K7002AF
60	±20	200			SSM3K7002BFS *	SSM3K7002BFU *		SSM3K7002BF *	
60	±20	200						2SK1062	
P-ch	-20	±8	-330		SSM3J36MFV	SSM3J36FS		SSM3J36TU	
	-20	±10	-100	SSM3J16CT	SSM3J16FV	SSM3J16FS	SSM3J16FU		
	-20	±10	-100	SSM3J35CT	SSM3J35MFV	SSM3J35FS			
	-30	±20	-100	SSM3J15CT	SSM3J15FV	SSM3J15FS	SSM3J15FU		SSM3J15F
	-30	±20	-200						2SJ305
	-30	±20	-200				SSM3J09FU		
	-50	-7	-50				2SJ344		2SJ343
-60	±20	-200						2SJ168	

★: Internal 1-MΩ resistor (R_{GS})

#: High ESD protection

• Contact the Toshiba sales representative for information about RoHS compliance before you purchase any components.

Vth (V)		Ron (Ω)			@VGS (V)	ton (ns) Typ.	toff (ns) Typ.
Min	Max	Typ.	Max				
0.7	1.3	4	12	2.5	160	190	
0.35	1.0	3.07	5.6	1.5	18	36	
0.6	1.1	5.2	15	1.5	70	125	
0.4	1.0	5	20	1.2	115	300	
0.35	1.0	0.95	1.52	1.5	30	75	
0.35	1.0	0.95	1.52	1.5	30	75	
0.8	1.5	4	7	2.5	50	180	
0.8	1.5	3.3	5.7	2.5	5.5	35	
0.8	1.5	4.0	7.0	2.5	50	200	
0.5	1.5	1.2	2.0	2.5	60	120	
1.1	1.8	0.8	1.2	4	72	68	
0.9	1.5	22	40	2.5	100	40	
1.0	2.5	1.8	3.3	4.5	3	7	
1.5	3.1	2.1	3.3	4.5	3.3	14.5	
2.0	3.5	0.6	1.0	10	14	75	
-0.3	-1.0	2.23	3.60	-1.5	90	200	
-0.6	-1.1	18	45	-1.5	130	190	
-0.4	-1.0	11	44	-1.2	175	251	
-1.1	-1.7	14	32	-2.5	65	175	
-0.5	-1.5	2.4	4.0	-2.5	60	150	
-1.1	-1.8	3.3	4.2	-4	85	85	
-0.8	-2.5	20	50	-4	150	130	
-2.0	-3.5	1.3	2.0	-10	14	100	

*: New product

** : Under development

Small-Signal MOSFETs (Dual Type)

Polarity	Absolute Maximum Ratings			Package					Internal FETs	V _{th} (V)		R _{on} (Ω)		
	V _{DD} S (V)	V _{GS} S (V)	I _D (mA)	ESV	ES6	USV	US6	UF6		Min	Max	Typ	Max	@V _{GS} (V)
				(mm)	(mm)	(mm)	(mm)	(mm)						
N-ch x 2	20	10	100				SSM6N04FU ★ ▲4		SSM3K04FU x 2	0.7	1.3	4	12	2.5
	20	±10	100	SSM5N16FE ▲1	SSM6N16FE ▲1	SSM5N16FU ▲1	SSM6N16FU ▲1		SSM3K16FU x 2	0.6	1.1	5.2	15	1.5
	20	±10	250		SSM6N37FE		SSM6N37FU **		SSM3K37MFV x 2	0.35	1.0	3.07	5.6	1.5
	20	±10	180		SSM6N35FE ▲1		SSM6N35FU ▲1		SSM3K35MFV x 2	0.4	1.0	5	20	1.2
	20	±10	500		SSM6N36FE ▲1			SSM6N36TU ▲1	SSM3K36TU x 2	0.35	1.0	0.95	1.52	1.5
	20	±10	500				SSM6N43FU ▲1		SSM3K43FS x 2	0.35	1.0	0.95	1.52	1.5
	30	±20	100	SSM5N15FE ▲1	SSM6N15FE ▲1	SSM5N15FU ▲1	SSM6N15FU ▲1		SSM3K15FU x 2	0.8	1.5	4	7	2.5
	30	±20	100		SSM6N15AFE **		SSM6N15AFU **		SSM3K15AMPV x 2	0.8	1.5	3.3	5.7	2.5
	30	±20	100		SSM6N44FE ▲1		SSM6N44FU ▲1		SSM3K44FS x 2	0.8	1.5	4.0	7.0	2.5
	30	±20	400				SSM6N09FU ▲1		SSM3K09FU x 2	1.1	1.8	0.8	1.2	4
	50	±7	100				SSM6N17FU ▲1		SSM3K17FU x 2	0.9	1.5	22	40	2.5
	60	±20	200				SSM6N7002AFU ▲1		SSM3K7002AFU x 2	1.0	2.5	1.8	3.3	4.5
60	±20	200		SSM6N7002BFU ▲1 *		SSM6N7002BFU ▲1 *		SSM3K7002BFU x 2	1.5	3.1	2.1	3.3	4.5	
P-ch x 2	-20	±10	-100	SSM5P16FE ▲2	SSM6P16FE ▲2	SSM5P16FU ▲2	SSM6P16FU ▲2		SSM3J16FU x 2	-0.6	-1.1	18	45	-1.5
	-20	±10	-100		SSM6P35FE ▲2		SSM6P35FU ▲2		SSM3J35FU x 2	-0.4	-1.0	11	44	-1.2
	-20	±8	-330		SSM6P36FE ▲2 *			SSM6P36TU ▲2 *	SSM3J36TU x 2	-0.3	-1.0	2.23	3.6	-1.5
	-20	±12	-200			SSM5P05FU ▲2	SSM6P05FU ▲2		SSM3J05FU x 2	-0.6	-1.1	3.2	4	-2.5
	-30	±20	-200				SSM6P09FU ▲2		SSM3J09FU x 2	-1.1	-1.8	3.3	4.2	-4
-30	±20	-100	SSM5P15FE ▲2	SSM6P15FE ▲2	SSM5P15FU ▲2	SSM6P15FU ▲2		SSM3J15FU x 2	-1.1	-1.7	14	32	-2.5	
N-ch + P-ch	20	±10	180						SSM3K35FU	0.4	1.0	5	20	1.2
	-20	±10	-100		SSM6L35FE ▲3		SSM6L35FU ▲3		+ SSM3J35FU	-0.4	-1.0	11	4.4	-1.2
	20	±10	500		SSM6L36FE ▲3 *			SSM6L36TU ▲3 *	SSM3K36TU	0.35	1.0	0.95	1.52	1.5
	-20	±8	-330						+ SSM3J36TU	-0.3	-1.0	2.23	3.6	-1.5
	30	±20	400				SSM6L09FU ▲3		SSM3K09FU	1.1	1.8	0.8	1.2	4
-30	±20	-200						SSM3J09FU	-1.1	-1.8	3.3	4.2	-4	

★: Internal 1-MΩ resistor (R_{GS})

- The products shown in bold are also manufactured in offshore fabs.
- Contact the Toshiba sales representative for information about RoHS compliance before you purchase any components.

*: New product

** : Under development

◆ Internal Connections

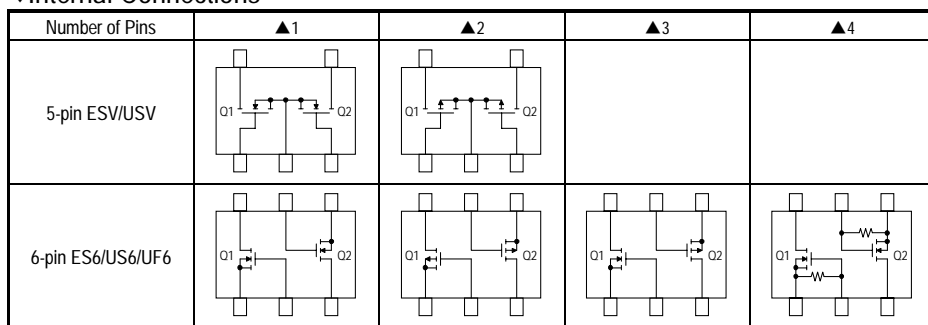

◆ The internal connection diagrams only show the general configurations of the circuits.

$V_{DS} \leq 60\text{ V}$ (Power MOSFETs) (N-ch MOSFETs)

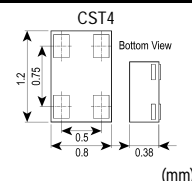
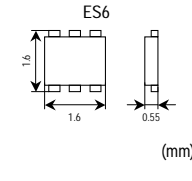
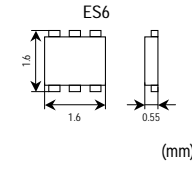
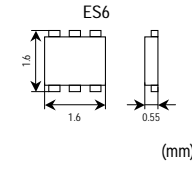
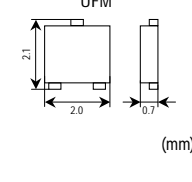
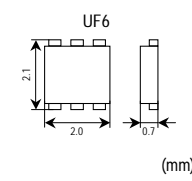
Package	Polarity	Part Number	V_{DS} (V)	V_{GS} (V)	I_D (A)	P_D (W)	$R_{DS(on)}$ Max (m Ω)				C_{iss} (pF)	Internal FETs	Internal Connections
							$V_{GS} = 1.5\text{ V}$	$V_{GS} = 1.8\text{ V}$	$V_{GS} = 2.5\text{ V}$	$V_{GS} = 4.0\text{ V}$			
 (mm)	N-ch	SSM4K27CT	20	± 12	0.5	0.4	—	390	260	205	174	—	(4)
 (mm)	N-ch	SSM6K211FE *	20	± 10	3.2	0.5	118	82	59	47(@4.5 V)	510	—	(2)
		SSM6K203FE	20	± 10	2.8	0.5	153	106	76	61	400	—	(2)
		SSM6K202FE	30	± 12	2.3	0.5	—	145	101	85	270	—	(2)
		SSM6K204FE	20	± 10	2.0	0.5	307	214	164	126	195	—	(2)
		SSM6K208FE	30	± 12	1.9	0.5	—	296	177	133	123	—	(2)
		SSM6K25FE	20	± 12	0.5	0.5	—	395	190	145	268	—	(2)
		SSM6K24FE	30	± 12	0.5	0.5	—	—	180	145	245	—	(2)
		SSM6K22FE	20	± 12	1.4	0.5	—	—	230	170	125	—	(2)
		SSM6K210FE	30	± 20	1.4	0.5	—	—	—	371	57	—	(2)
		SSM6K30FE	20	± 20	1.2	0.5	—	—	—	420	60	—	(2)
 (mm)	N-ch x 2	SSM6K31FE	20	± 20	1.2	0.5	—	—	—	540	36	—	(2)
 (mm)	N-ch x 2	SSM6N42FE *	20	± 10	0.8	0.15	600	450	330	240	90	—	(1)
 (mm)	N-ch	SSM3K123TU	20	± 10	4.2	0.5	66	43	32	28	1010	—	(3)
		SSM3K121TU	20	± 10	3.2	0.5	140	93	63	48	400	—	(3)
		SSM3K104TU	20	± 12	3.0	0.5	—	110	74	56	320	—	(3)
		SSM3K119TU	30	± 12	2.5	0.5	—	134	90	74	270	—	(3)
		SSM3K116TU	30	± 12	2.2	0.5	—	—	135	100	245	—	(3)
		SSM3K122TU	20	± 10	2.0	0.5	304	211	161	123	195	—	(3)
		SSM3K101TU	20	± 12	2.2	0.5	—	230	138	103	125	—	(3)
		SSM3K127TU	30	± 12	2.0	0.5	—	286	167	123	123	—	(3)
		SSM3K131TU	30	± 20	6.0	0.5	—	—	—	41.5 (@4.5 V)	450	—	(3)
		SSM3K124TU	30	± 20	2.4	0.5	—	—	—	120	180	—	(3)
		SSM3K105TU	30	± 20	2.1	0.5	—	—	—	200	102	—	(3)
		SSM3K107TU	20	± 20	1.5	0.5	—	—	—	410	60	—	(3)
		SSM3K128TU	30	± 20	1.5	0.5	—	—	—	360	57	—	(3)
		SSM3K106TU	20	± 20	1.2	0.5	—	—	—	530	36	—	(3)
 (mm)	N-ch	SSM6K403TU	20	± 10	4.2	0.5	66	43	32	28	1050	—	(2)
		SSM6K18TU	20	± 12	4.0	0.5	—	—	54	40	1100	—	(2)
		SSM6K411TU	20	± 12	10	0.5	—	—	23.8	12(@4.5 V)	450	—	(2)
		SSM6K404TU	20	± 10	2.0	0.5	147	100	70	55	400	—	(2)
		SSM6K405TU	20	± 20	4.4	0.5	307	214	164	126	195	—	(2)
		SSM6K406TU	30	± 20	3.0	0.5	—	—	—	38.5 (@4.5 V)	490	—	(2)
		SSM6K34TU	30	± 20	2.0	0.5	—	—	—	77 (@4.5 V)	470	—	(2)
		SSM6K32TU #	60	± 20	2.0	0.5	—	—	—	440	140	—	(2)
		SSM6K407TU	60	± 10	1.6	0.5	—	—	—	440	150	—	(2)
		N-ch x 2	SSM6N39TU	20	± 12	0.8	0.5	247	190	139	119	260	—
	SSM6N29TU		20	± 12	0.5	0.5	—	235	178	143	268	SSM3K102TU x 2	(1)
	SSM6N25TU		20	± 12	0.5	0.5	—	395	190	145	268	SSM6K25FE x 2	(1)
	SSM6N24TU		30	± 20	1.6	0.5	—	—	180	145	245	SSM6K24FE x 2	(1)
	SSM6N40TU	30	± 12	0.5	0.5	—	—	—	182	180	—	(1)	

#: High ESD protection

*: New product

- Contact the Toshiba sales representative for information about RoHS compliance before you purchase any components.

◆ Internal Connections

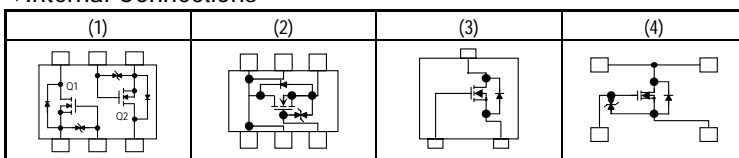

◆ The internal connection diagrams only show the general configurations of the circuits.

VDSS ≤ 60 V (Power MOSFETs) (N-ch MOSFETs) (Continued)

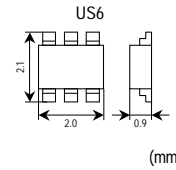
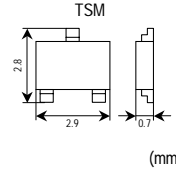
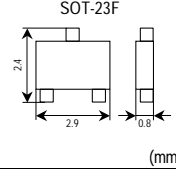
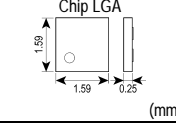
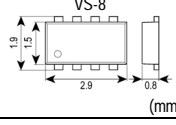
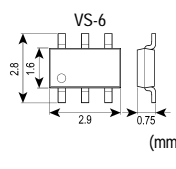
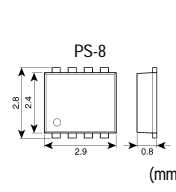
Package	Polarity	Part Number	V _{DSS} (V)	V _{GSS} (V)	I _D (A)	P _D (W)	R _{DS(ON)} Max (mΩ)						C _{iss} (pF)	Q _g (nC) (typ.)	Internal Connections	
							V _{GS} = 1.5 V	V _{GS} = 1.8 V	V _{GS} = 2.0 V	V _{GS} = 2.5 V	V _{GS} = 4 V	V _{GS} = 4.5 V				V _{GS} = 10 V
 (mm)	N-ch	SSM6K08FU	20	±12	1.6	0.3	—	—	210	140	105	—	—	306	—	(1)
		SSM6K06FU	20	±12	1.1	0.3	—	—	—	210	160	—	—	125	—	(1)
		SSM6K07FU	30	±20	1.5	0.3	—	—	—	—	220	—	130	102	—	(1)
 (mm)	N-ch	SSM3K310T	20	±10	5.0	0.7	66	43	—	32	28	—	—	1120	14.8	(7)
		SSM3K309T	20	±12	4.7	0.7	—	47	—	35	31	—	—	1020	—	(7)
		SSM3K301T	20	±12	3.5	0.7	—	110	—	74	56	—	—	320	4.8	(7)
		SSM3K01T	30	±10	3.2	1.25	—	—	—	150	120	—	—	152	—	(7)
		SSM3K02T	30	±10	2.5	1.25	—	—	—	250	200	—	—	115	—	(7)
		SSM3K316T	30	±12	4.0	1.25	—	131	—	87	—	65	53	270	4.3	(7)
		SSM3K315T	30	±20	6.0	1.25	—	—	—	—	—	41.5	27.6	450	10.1	(7)
		SSM3K14T	30	±20	4.0	1.25	—	—	—	—	67	57	39	460	5	(7)
		SSM3K320T	30	±20	4.2	1.4	—	—	—	—	—	77	50	190	4.6	(7)
SSM3K318T	*	60	±20	2.5	0.7	—	—	—	—	—	145	107	235	7	(7)	
 (mm)	N-ch	SSM3K329R	*	30	±12	3.5	2	—	289	—	170	—	126	—	—	(7)
 (mm)	N-ch Dual	TPCL4201	20	±12	6	1.5	—	—	—	52	33	31	—	—	11.5	(6)
		TPCL4203	24	±12	6	1.5	—	—	—	55	38	36	—	—	10	(6)
		TPCL4202	30	±12	6	1.5	—	—	—	64	42	40	—	—	10	(6)
 (mm)	N-ch Single	TPCF8003	20	±12	7	2.5	—	—	—	34	—	18	—	—	9.5	(2)
	N-ch Dual	TPCF8002	30	±20	7	2.5	—	—	—	—	—	32	21	—	11.5	(2)
 (mm)	N-ch Single	TPC6012	20	±12	6	2.2	—	—	—	38	—	20	—	—	9	(1)
		TPC6008-H	30	±20	5.9	2.2	—	—	—	—	—	74	60	232	4.8	(1)
		TPC6011	30	±20	6	2.2	—	—	—	—	—	32	20	—	14	(1)
		TPC6005	30	±12	6	2.2	—	—	41	35	—	28	—	—	19	(1)
		TPC6006-H	40	±20	3.9	2.2	—	—	—	—	—	100	75	—	4.4	(1)
		TPC6009-H	40	±20	5.3	2.2	—	—	—	—	—	98	81	225	4.7	(1)
		TPC6010-H	60	±20	6.1	2.2	—	—	—	—	—	63	59	640	12	(1)
 (mm)	N-ch Single	TPCP8006	20	±12	9.1	1.68	—	—	—	13.7	—	10	—	—	22	(4)
		TPCP8008-H	30	±20	8	1.68	—	—	—	—	—	23	20	—	14.7	(4)
		TPCP8004	30	±20	8.3	1.68	—	—	—	—	—	14	8.5	—	26	(4)
		TPCP8005-H	30	±20	11	1.68	—	—	—	—	—	15.7	12.9	—	20	(4)
		TPCP8007-H	60	±20	5	1.68	—	—	—	—	—	64	57	—	11	(4)
	N-ch Dual	TPCP8201	30	±20	4.2	1.48	—	—	—	—	—	77	50	—	10	(3)
		TPCP8204	30	±20	4.2	1.48	—	—	—	—	—	77	50	190	4.6	(3)
		TPCP8203	40	±20	4.7	1.48	—	—	—	—	—	60	40	—	16	(3)

• Contact the Toshiba sales representative for information about RoHS compliance before you purchase any components.

*: New product

◆ Internal Connections

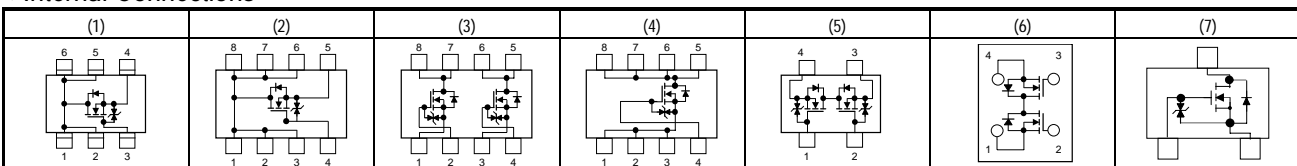

Note: Some MOSFETs do not have a Zener diode between gate and source.

◆ The internal connection diagrams only show the general configurations of the circuits.

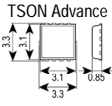
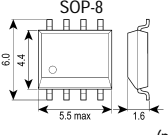
Package	Polarity	Part Number	V _{DSS} (V)	V _{GSS} (V)	I _D (A)	P _D (W)	R _{DS(ON)} Max (mΩ)					Q _g (nC) (typ.)	Internal Connections
							V _{GS} = 2.0 V	V _{GS} = 2.5 V	V _{GS} = 4 V	V _{GS} = 4.5 V	V _{GS} = 10 V		
 TSON Advance (mm)	N-ch Single	TPCC8061-H	30	±20	8	15	—	—	—	29	26	11	(2)
		TPCC8003-H	30	±20	13	22	—	—	—	19.3	16.9	17	(2)
		TPCC8064-H	30	±20	19	30	—	—	—	10.6	8.2	23	(2)
		TPCC8006-H	30	±20	22	27	—	—	—	9.3	8	27	(2)
		TPCC8001-H	30	±20	22	30	—	—	—	10.6	8.3	27	(2)
		TPCC8002-H	30	±20	22	30	—	—	—	10.6	8.3	27	(2)
		TPCC8005-H	30	±20	26	30	—	—	—	7.4	6.4	35	(2)
		TPCC8007	20	±12	27	30	—	8.7	—	4.6	—	26	(2)
		TPCC8008	30	±25	25	30	—	—	—	12.8	6.8	30	(2)
		TPCC8009	30	±20	24	27	—	—	—	—	7	26	(2)
 SOP-8 (mm)	N-ch Single	TPC8061-H	30	±20	8	1.9	—	—	—	30	25	11	(2)
		TPC8025	30	±20	11	1.9	—	—	—	14.5	9	26	(2)
		TPC8030	30	±25	11	1.9	—	—	—	17	9	24	(2)
		TPC8031-H	30	±20	11	1.9	—	—	—	16.1	13.3	21	(2)
		TPC8037-H	30	±20	12	1.9	—	—	—	13.9	11.4	21	(2)
		TPC8038-H	30	±20	12	1.9	—	—	—	13.9	11.4	21	(2)
		TPC8026	30	±20	13	1.9	—	—	—	10	6.6	42	(2)
		TPC8040-H	30	±20	13	1.9	—	—	—	11.1	9.7	24	(2)
		TPC8041	30	±20	13	1.9	—	—	—	13.5	7	27	(2)
		TPC8032-H	30	±20	15	1.9	—	—	—	8.6	6.5	33	(2)
		TPC8063-H	30	±20	17	1.9	—	—	—	8.9	7	27	(2)
		TPC8033-H	30	±20	17	1.9	—	—	—	7.2	5.3	42	(2)
		TPC8039-H	30	±20	17	1.9	—	—	—	6.9	6	36	(2)
		TPC8062-H	30	±20	18	1.9	—	—	—	7.3	5.8	34	(2)
		TPC8027	30	±20	18	1.9	—	—	—	5.5	2.7	113	(2)
		TPC8028	30	±20	18	1.9	—	—	—	8	4.3	45	(2)
		TPC8029	30	±20	18	1.9	—	—	—	7	3.8	49	(2)
		TPC8035-H	30	±20	18	1.9	—	—	—	3.6	3.2	82	(2)
		TPC8036-H	30	±20	18	1.9	—	—	—	5.1	4.5	49	(2)
		TPC8042	30	±20	18	1.9	—	—	—	6.5	3.4	56	(2)
		TPC8060-H	30	±20	18	1.9	—	—	—	4.2	3.7	65	(2)
		TPC8034-H	30	±20	18	1.9	—	—	—	4.5	3.5	68	(2)
		TPC8022-H	40	±20	7.5	1.9	—	—	—	3.5	2.7	11	(2)
		TPC8052-H	40	±20	12	1.9	—	—	—	13.3	11.5	25	(2)
		TPC8047-H	40	±20	16	1.9	—	—	—	8.8	7.5	43	(2)
		TPC8046-H	40	±20	18	1.9	—	—	—	6.6	5.7	57	(2)
		TPC8045-H	40	±20	18	1.9	—	—	—	4.4	3.9	90	(2)
		TPC8053-H	60	±20	9	1.9	—	—	—	24.2	22.5	25	(2)
		TPC8050-H	60	±20	11	1.9	—	—	—	15.5	14.5	41	(2)
		TPC8049-H	60	±20	13	1.9	—	—	—	11.5	10.7	56	(2)
TPC8048-H	60	±20	16	1.9	—	—	—	7.4	6.9	87	(2)		

©: Common-drain type

- Contact the Toshiba sales representative for information about RoHS compliance before you purchase any components.

◆Internal Connections

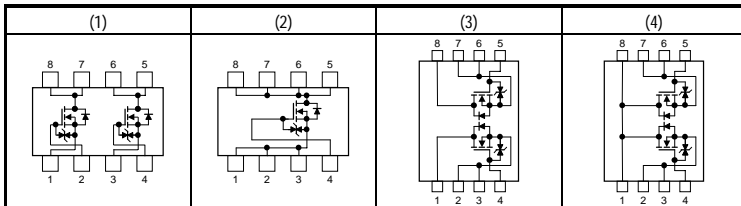

Note: Some MOSFETs do not have a Zener diode between gate and source.

- ◆The internal connection diagrams only show the general configurations of the circuits.

V_{DS} ≤ 60 V (Power MOSFETs) (N-ch MOSFETs) (Continued)

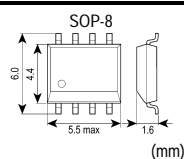
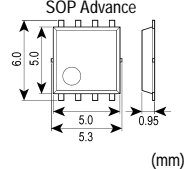
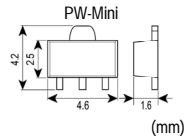
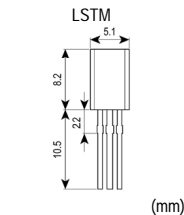
Package	Polarity	Part Number	V _{DS} (V)	V _{GSS} (V)	I _D (A)	P _D (W)	R _{DS(ON)} Max (mΩ)					Q _g (nC) (typ.)	Internal Connections
							V _{GS} = 2.0 V	V _{GS} = 2.5 V	V _{GS} = 4 V	V _{GS} = 4.5 V	V _{GS} = 10 V		
 <p>SOP-8 (mm)</p>	N-ch Dual	TPC8208	20	±12	5	1.5	—	70	50	—	—	9.5	(1)
		TPC8207	20	±12	6	1.5	—	30	20	—	—	22	(1)
		TPC8212-H	30	±20	6	1.5	—	—	—	27	21	16	(1)
		TPC8216-H	30	±20	6.4	1.5	—	—	—	23	20	14	(1)
		TPC8218-H	60	±20	3.8	1.5	—	—	—	64	57	11	(1)
 <p>SOP Advance (mm)</p>	N-ch Single	TPCA8011-H	20	±12	40	45	—	7.5	—	3.5	—	32	(2)
		TPCA8023-H	30	±20	21	30	—	—	—	15.7	12.9	21	(2)
		TPCA8063-H	30	±20	22	35	—	—	—	8.7	6.8	27	(2)
		TPCA8040-H	30	±20	23	30	—	—	—	10.8	5.6	23	(2)
		TPCA8030-H	30	±20	24	30	—	—	—	13.4	11	21	(2)
		TPCA8031-H	30	±20	24	30	—	—	—	13.4	11	21	(2)
		TPCA8021-H	30	±20	27	45	—	—	—	13	9	23	(2)
		TPCA8062-H	30	±20	28	42	—	—	—	7.1	5.6	34	(2)
		TPCA8018-H	30	±20	30	45	—	—	—	8.2	6.2	34	(2)
		TPCA8039-H	30	±20	34	45	—	—	—	6.6	5.7	36	(2)
		TPCA8024	30	±20	35	45	—	—	—	7.8	4.3	45	(2)
		TPCA8036-H	30	±20	38	45	—	—	—	4.8	4.2	50	(2)
		TPCA8012-H	30	±20	40	45	—	—	—	6.8	4.9	42	(2)
		TPCA8025	30	±20	40	45	—	—	—	6	3.5	49	(2)
		TPCA8019-H	30	±20	45	45	—	—	—	4.1	3.1	66	(2)
		TPCA8026	30	±20	45	45	—	—	—	4.5	2.2	113	(2)
		TPCA8042	30	±20	45	45	—	—	—	5.7	3.3	56	(2)
		TPCA8060-H	30	±20	45	45	—	—	—	3.9	3.4	66	(2)
		TPCA8028-H	30	±20	50	45	—	—	—	3.2	2.8	88	(2)
		TPCA8055-H	30	±20	60	45	—	—	—	2.4	1.9	76	(2)
		TPCA8020-H	40	±20	7.5	30	—	—	—	35	27	11	(2)
		TPCA8052-H	40	±20	20	30	—	—	—	13.1	11.3	25	(2)
		TPCA8047-H	40	±20	32	45	—	—	—	8.5	7.3	43	(2)
TPCA8046-H	40	±20	38	45	—	—	—	6.3	5.4	55	(2)		
TPCA8045-H	40	±20	46	45	—	—	—	4.1	3.6	90	(2)		
TPCA8053-H	60	±20	15	30	—	—	—	24	22.3	25	(2)		
TPCA8050-H	60	±20	24	45	—	—	—	15.3	14.2	41	(2)		
TPCA8049-H	60	±20	28	45	—	—	—	11.2	10.4	55	(2)		
 <p>PW-Mini (mm)</p>	N-ch Single	2SK2615	60	—	2	1.5	—	—	440	—	300	6	
		2SK3658	60	—	2	1.5	—	—	440	—	300	5.0	
 <p>LSTM (mm)</p>	N-ch Single	2SK2989	50	—	5	0.9	—	—	330	—	150	6.5	
		2SK2961	60	—	2	0.9	—	—	380	—	270	5.8	

• Contact the Toshiba sales representative for information about RoHS compliance before you purchase any components.

◆Internal Connections

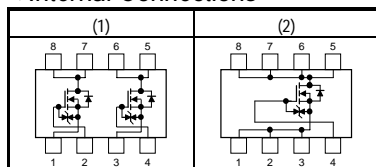

Note: Some MOSFETs do not have a Zener diode between gate and source.

◆The internal connection diagrams only show the general configurations of the circuits.

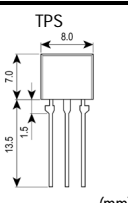
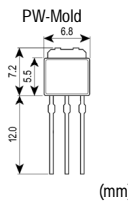
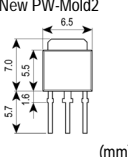
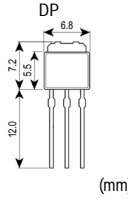
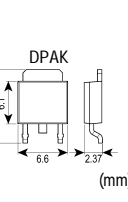
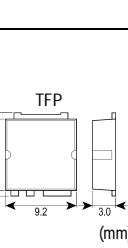
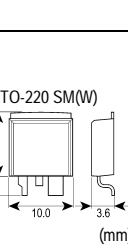
Package	Polarity	Part Number	V _{DSS} (V)	V _{GSS} (V)	I _D (A)	P _D (W)	R _{DS(ON)} Max (mΩ)						Q _g (nC) (typ.)	Internal Connections
							V _{GS} = 2.0 V	V _{GS} = 2.5 V	V _{GS} = 4 V	V _{GS} = 4.5 V	V _{GS} = 6 V	V _{GS} = 10 V		
 TPS (mm)	N-ch Single	2SK2229	60	—	5	1.3	—	—	300	—	—	160	12	
 PW-Mold (mm)	N-ch Single	2SK2493	16	—	5	20	—	120	100	—	—	—	23	
		2SK4033	60	—	5	20	—	—	150	—	—	100	15	
 New PW-Mold2 (mm)	N-ch Single	2SK4017	60	—	5	20	—	—	150	—	—	100	15	
 DP (mm)	N-ch Single	2SK2614	50	—	20	40	—	—	80	—	—	46	25	
		2SK2782	60	—	20	40	—	—	90	—	—	55	25	
 DPAK (mm)	N-ch Single	TK40P03M1	30	±20	40	40	—	—	—	14.4	—	10.8	9.4	
		TK45P03M1	30	±20	45	33	—	—	—	12	—	9.4	13	
		TK50P03M1	30	±20	50	60	—	—	—	9.8	—	7.5	13.3	
		TK60P03M1	30	±20	60	48	—	—	—	7.9	—	6.2	21	
		TK20P04M1	40	±20	20	27	—	—	—	34	—	29	7.6	
		TK40P04M1	40	±20	40	60	—	—	—	13.4	—	11	15	
 TFP (mm)	N-ch Single	TK50P04M1	40	±20	50	60	—	—	—	10.2	—	8.7	20	
		TK70X04K3	40	—	70	80	—	—	—	—	—	5.6	62	
		TK70X04K3Z	40	—	70	80	—	—	—	—	—	5.6	62	
		2SK3843	40	—	75	125	—	—	—	8	—	3.5	210	
		TK80X04K3	40	—	80	125	—	—	—	—	—	3.5	100	
		TK70X06K3	60	—	70	80	—	—	—	—	—	8	62	
		2SK3842	60	—	75	125	—	—	—	—	—	5.8	196	
2SK4034	60	—	75	125	—	—	—	10	—	5.8	196			
 TO-220 SM(W) (mm)	N-ch Single	TK100F04K3	40	—	100	200	—	—	—	—	—	3	102	
		TK100F04K3L	40	—	100	200	—	—	—	—	4.5	3	105	
		TK150F04K3	40	—	150	300	—	—	—	—	—	2.1	166	
		TK100F06K3	60	—	100	200	—	—	—	—	—	5	98	
		TK150F04K3L	40	—	150	300	—	—	—	—	3.2	2.1	190	
		TK130F06K3	60	—	130	300	—	—	—	—	—	3.4	170	

• Contact the Toshiba sales representative for information about RoHS compliance before you purchase any components.

V_{DS} ≤ 60 V (Power MOSFETs) (N-ch MOSFETs) (Continued)

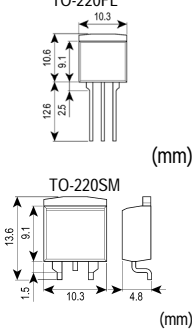
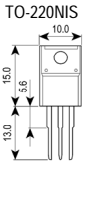
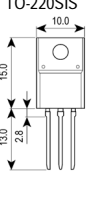
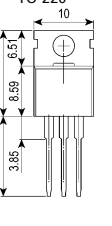
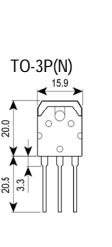
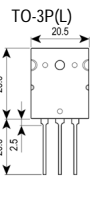
Package	Polarity	Part Number	V _{DS} (V)	I _D (A)	P _D (W)	R _{DS(ON)} Max (mΩ)					Q _g (nC) (typ.)	Internal Connections
						V _{GS} = 2.0 V	V _{GS} = 2.5 V	V _{GS} = 4 V	V _{GS} = 4.5 V	V _{GS} = 10 V		
 <p>TO-220FL (mm)</p> <p>TO-220SM (mm)</p>	N-ch Single	2SK3847	40	32	30	—	—	—	26	16	40	
		2SK3051	50	45	40	—	—	—	—	30	36	
		2SK2311	60	25	40	—	—	80	—	46	38	
		2SK2266	60	45	65	—	—	55	—	30	60	
		2SK2376	60	45	100	—	—	25	—	17	110	
 <p>TO-220NIS (mm)</p>	N-ch Single	2SK3846	40	26	25	—	—	—	28	18	40	
		2SK2507	50	25	30	—	—	80	—	46	25	
		2SK2886	50	45	40	—	—	36	—	20	66	
		2SK2232	60	25	35	—	—	80	—	46	38	
		2SK3662	60	35	35	—	—	19	—	12.5	91	
		2SK2385	60	36	40	—	—	55	—	30	60	
 <p>TO-220SIS (mm)</p>	N-ch Single	TK30A06J3A	60	30	25	—	—	—	35	26	36	
		TK70A06J1	60	70	45	—	—	—	7.6	6.4	87	
 <p>TO-220 (mm)</p>	N-ch Single	TK25E06K3	60	25	64	—	—	—	—	18	—	
		TK50E06K3A	60	50	104	—	—	—	—	8.5	54	
 <p>TO-3P(N) (mm)</p>	N-ch Single	2SK3506	30	45	100	—	—	—	—	20	39	
		TK70J04J3	40	70	150	—	—	—	8.3	3.8	210	
		2SK2550	50	45	100	—	—	—	—	30	36	
		2SK2744	50	45	125	—	—	—	—	20	68	
		2SK2551	50	50	150	—	—	—	—	11	130	
		2SK2745	50	50	150	—	—	16	—	9.5	130	
		2SK2233	60	45	100	—	—	55	—	30	60	
		2SK2398	60	45	100	—	—	—	—	30	60	
		2SK2173	60	50	125	—	—	25	—	17	110	
		2SK2445	60	50	125	—	—	—	—	18	110	
 <p>TO-3P(L) (mm)</p>	N-ch Single	2SK2313	60	60	150	—	—	15	—	11	170	
		2SK3845	60	70	125	—	—	—	—	5.8	196	
		2SK2267	60	60	150	—	—	15	—	11	170	

• Contact the Toshiba sales representative for information about RoHS compliance before you purchase any components.

60 V < V_{DSS} ≤ 250 V (Power MOSFETs) (N-ch MOSFETs)

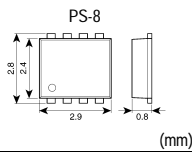
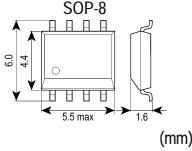
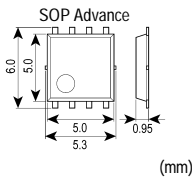
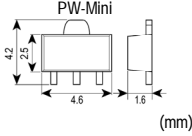
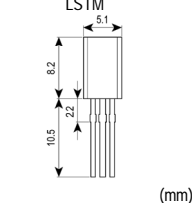
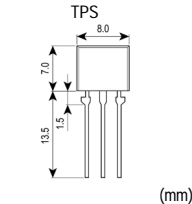
Package	Polarity	Part Number	V _{DSS} (V)	V _{GSS} (V)	I _D (A)	P _D (W)	R _{DS(on)} Max (mΩ)							Q _g (nC) (typ.)	Internal Connections	
							V _{GS} = 1.8 V	V _{GS} = 2.0 V	V _{GS} = 2.5 V	V _{GS} = 4 V	V _{GS} = 4.5 V	V _{GS} = 7 V	V _{GS} = 10 V			
 (mm)	N-ch Single	TPCP8003-H	100	±20	2.2	1.68	—	—	—	—	190	—	180	7.5	(1)	
 (mm)	N-ch Single	TPC8051-H	80	±20	13	1.9	—	—	—	—	10.1	—	9.7	85	(1)	
		TPC8054-H	100	±20	10	1.9	—	—	—	—	21.5	—	19.9	92	(1)	
		TPC8012-H	200	±20	1.8	1.9	—	—	—	—	—	—	400	11	(1)	
 (mm)	N-ch Single	TPCA8070-H	80	±25	12	45	—	—	—	—	—	—	35	21	(1)	
		TPCA8051-H	80	±20	28	45	—	—	—	—	9.8	—	9.4	91	(1)	
		TPCA8072-H	100	±25	8	45	—	—	—	—	—	—	71	22	(1)	
		TPCA8006-H	100	±20	18	45	—	—	—	—	—	—	—	67	12	(1)
		TPCA8071-H	100	±25	20	45	—	—	—	—	—	—	—	20	70	(1)
		TPCA8054-H	100	±20	20	45	—	—	—	—	21.3	—	—	19.7	89	(1)
		TPCA8009-H	150	±20	7	45	—	—	—	—	—	—	—	350	10	(1)
 (mm)	N-ch Single	2SK2963	100	—	1	1.5	—	—	—	950	—	—	700	6.3		
		2SK2992	200	—	1	1.5	—	—	—	—	—	—	3500	3		
 (mm)	N-ch Single	2SK2962	100	—	1	0.9	—	—	—	950	—	—	700	6.3		
		2SK3670	150	—	0.67	0.9	—	—	—	1700	—	—	—	4.6		
 (mm)	N-ch Single	2SK2200	100	—	3	1.3	—	—	—	450	—	—	350	13.5		
		2SK2400	100	—	5	1.3	—	—	—	300	—	—	230	22		
		2SK2835	200	—	5	1.3	—	—	—	—	—	—	800	10		

• Contact the Toshiba sales representative for information about RoHS compliance before you purchase any components.

◆Internal Connections

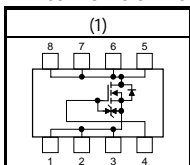

Note: Some MOSFETs do not have a Zener diode between gate and source.

◆The internal connection diagrams only show the general configurations of the circuits.

60 V < V_{DSS} ≤ 250 V (Power MOSFETs) (N-ch MOSFETs) (Continued)

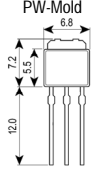
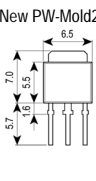
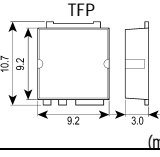
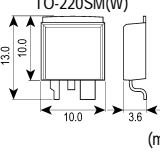
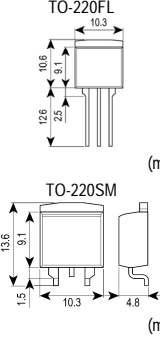
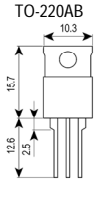
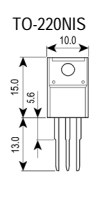
Package	Polarity	Part Number	V _{DSS} (V)	I _D (A)	P _D (W)	R _{DS(ON)} Max (mΩ)							Q _g (nC) (typ.)	Internal Connections
						V _{GS} = 1.8 V	V _{GS} = 2.0 V	V _{GS} = 2.5 V	V _{GS} = 4 V	V _{GS} = 4.5 V	V _{GS} = 7 V	V _{GS} = 10 V		
 PW-Mold (mm)	N-ch Single	2SK2201	100	3	20	—	—	—	450	—	—	350	13.5	
		2SK2399	100	5	20	—	—	—	300	—	—	230	22	
		2SK3669	100	10	20	—	—	—	—	—	—	125	8.0	
		2SK3205	150	5	20	—	—	—	750	—	—	500	12	
		2SK2162	180	1	20	—	—	—	—	—	—	5000	—	
		2SK2920	200	5	20	—	—	—	—	—	—	800	10	
		2SK3462	250	3	20	—	—	—	—	—	—	1700	12	
2SK3342	250	4.5	20	—	—	—	—	—	—	1000	10			
 New PW-Mold2 (mm)	N-ch Single	2SK4018	100	3	20	—	—	—	450	—	—	350	13.5	
		2SK4019	100	5	20	—	—	—	300	—	—	230	22	
		2SK4020	200	5	20	—	—	—	—	—	—	800	10	
		2SK4022	250	3	20	—	—	—	—	—	—	1700	12	
2SK4021	250	4.5	20	—	—	—	—	—	—	1000	10			
 TFP (mm)	N-ch Single	2SK3387	150	18	100	—	—	—	—	—	—	120	57	
		TK50X15J1	150	50	125	—	—	—	—	—	—	30	75	
		2SK3444	200	25	125	—	—	—	—	—	—	82	44	
		2SK3388	250	20	125	—	—	—	—	—	—	105	100	
		2SK3445	250	20	125	—	—	—	—	—	—	105	45	
 TO-220SM(W) (mm)	N-ch Single	TK40F08K3	75	40	107	—	—	—	—	—	—	8.5	80	
		TK80F08K3	75	80	300	—	—	—	—	—	—	—	4.3	175
 TO-220FL TO-220SM (mm)	N-ch Single	2SK2789	100	27	60	—	—	—	130	—	—	85	50	
		2SK2401	200	15	75	—	—	—	—	—	—	180	40	
		2SK3625	200	25	125	—	—	—	—	—	—	82	44	
		2SK2598	250	13	60	—	—	—	—	—	—	250	40	
		2SK2993	250	20	100	—	—	—	—	—	—	105	100	
 TO-220AB (mm)	N-ch Single	2SK2314	100	27	75	—	—	—	130	—	—	85	50	
		2SK2914	250	7.5	20	—	—	—	—	—	—	500	20	
 TO-220NIS (mm)	N-ch Single	2SK2391	100	20	35	—	—	—	130	—	—	85	50	
		2SK2882	150	18	45	—	—	—	180	—	—	120	57	
		2SK2013	180	1	25	—	—	—	—	—	—	5000	—	
		2SK2381	200	5	25	—	—	—	—	—	—	800	10	
		2SK2350	200	8.5	30	—	—	—	—	—	—	400	17	
		2SK2965	200	11	35	—	—	—	—	—	—	260	30	
		2SK2382	200	15	45	—	—	—	—	—	—	180	40	
		2SK2417	250	7.5	30	—	—	—	—	—	—	500	20	
		2SK2508	250	13	45	—	—	—	—	—	—	250	40	
2SK3994	250	20	45	—	—	—	—	—	—	105	45			

• Contact the Toshiba sales representative for information about RoHS compliance before you purchase any components.

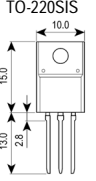
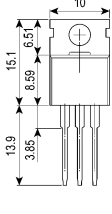
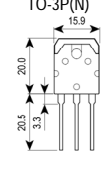
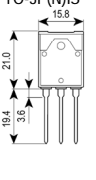
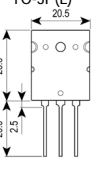
Package	Polarity	Part Number	V _{DSS} (V)	V _{GSS} (V)	I _D (A)	P _D (W)	R _{DS(ON)} Max (mΩ)							Q _g (nC) (typ.)	Internal Connections
							V _{GS} = 1.8 V	V _{GS} = 2.0 V	V _{GS} = 2.5 V	V _{GS} = 4 V	V _{GS} = 4.5 V	V _{GS} = 7 V	V _{GS} = 10 V		
 <p>TO-220SIS (mm)</p>	N-ch Single	TK40A08K3	75	±20	40	35	—	—	—	—	—	—	9	80	
		TK60A08J1	75	±20	60	45	—	—	—	—	9.3	—	7.8	86	
		TK80A08K3	75	±20	80	40	—	—	—	—	—	—	4.5	175	
		TK8A10K3	100	±20	8	18	—	—	—	—	—	—	120	12.9	
		TK12A10K3	100	±20	12	20	—	—	—	—	—	—	80	18	
		TK25A10K3	100	±20	25	25	—	—	—	—	—	—	40	34	
		TK40A10J1	100	±20	40	40	—	—	—	—	17	—	15	76	
		TK40A10K3	100	±20	40	40	—	—	—	—	—	—	15	85	
		TK55A10J1	100	±20	55	45	—	—	—	—	12	—	10.5	110	
 <p>TO-220 (mm)</p>	N-ch Single	TK50E08K3	75	±20	50	104	—	—	—	—	—	12	55		
		TK60E08K3	75	±20	60	128	—	—	—	—	—	—	9	—	
		TK18E10K3	100	±20	18	71	—	—	—	—	—	—	42	33	
		TK40E10K3	100	±20	40	147	—	—	—	—	—	—	15	84	
 <p>TO-3P(N) (mm)</p>	N-ch Single	2SK3940	75	—	70	150	—	—	—	—	—	7	200		
		2SK1381	100	—	50	150	—	—	—	46	—	—	32	88	
		2SK1529	180	—	10	120	—	—	—	—	—	—	830	—	
		2SK3497	180	—	10	130	—	—	—	—	—	150	—	36	
		2SK3176	200	—	30	150	—	—	—	—	—	—	52	125	
		2SK2967	250	—	30	150	—	—	—	—	—	—	68	132	
 <p>TO-3P(N)IS (mm)</p>	N-ch Single	2SK2467	180	—	9	80	—	—	—	—	—	830	—		
		2SK2995	250	—	30	90	—	—	—	—	—	—	68	132	
 <p>TO-3P(L) (mm)</p>	N-ch Single	2SK1382	100	—	60	200	—	—	—	29	—	20	176		
		2SK1530	200	—	12	150	—	—	—	—	—	—	625	—	

• Contact the Toshiba sales representative for information about RoHS compliance before you purchase any components.

250 V < V_{DSS} ≤ 700 V (Power MOSFETs) (N-ch MOSFETs)

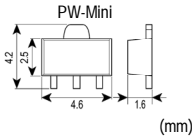
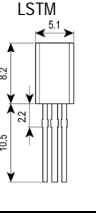
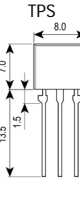
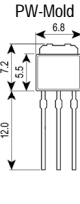
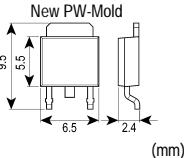
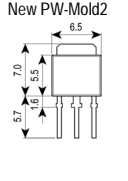
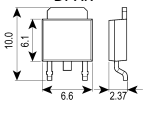
Package	Polarity	Part Number	V _{DSS} (V)	I _D (A)	P _D (W)	R _{Ds(ON)} Max (Ω)	Q _g (nC) (typ.)	Internal Connections
						V _{GS} = 10 V		
 PW-Mini (mm)	N-ch Single	2SK3471	500	0.5	1.5	18	3.8	
 LSTM (mm)	N-ch Single	2SK2998	500	0.5	0.9	18	3.8	
 TPS (mm)	N-ch Single	2SK3374	450	1	1.3	4.6	5	
		2SK3302	500	0.5	1.3	18	3.8	
		2SK2599	500	2	1.3	3.2	9	
		2SK2846	600	2	1.3	5.0	9	
 PW-Mold (mm)	N-ch Single	2SK3498	400	1	20	5.5	5.7	
		2SK3472	450	1	20	4.6	5	
		2SK3373	500	2	20	3.2	9	
		2SK3371	600	1	20	9.0	9	
		2SK2865	600	2	20	5.0	9	
 New PW-Mold (mm)	N-ch Single	2SK4103	500	5	40	1.5	16	
		TK2P60D	600	2	60	4.3	7	
 New PW-Mold2 (mm)	N-ch Single	2SK4023	450	1	20	4.6	5	
		2SK4026	600	1	20	9.0	9	
		2SK4002	600	2	20	5.0	9	
		TK2Q60D	600	2	60	4.3	7	
		2SK4003	600	3	20	2.2	15	
 DPAK (mm)	N-ch Single	TK4P50D	500	4	80	2.0	9	
		TK5P50D	500	5	80	1.5	11	
		TK7P50D	500	7	100	1.22	12	
		TK5P53D	525	5	80	1.5	11	
		TK6P53D	525	6	100	1.3	12	
		TK4P55DA	550	3.5	80	2.45	9	
		TK4P55D	550	4	80	1.88	11	
		TK4P60DA	600	3.5	80	1.7	11	
		TK4P60DB	600	3.7	80	2.0	11	

• Contact the Toshiba sales representative for information about RoHS compliance before you purchase any components.

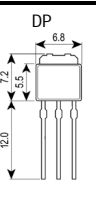
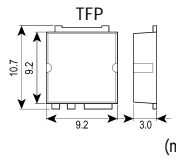
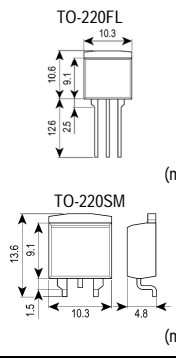
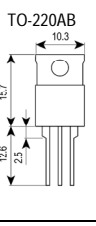
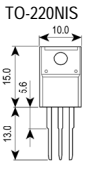
Package	Polarity	Part Number	V _{DSS} (V)	I _D (A)	P _D (W)	R _{DS(ON)} Max (Ω)	Q _g (nC) (typ.)	Internal Connections
						V _{GS} = 10 V		
 (mm)	N-ch Single	2SK3863	500	5	35	1.5	16	
 (mm)	N-ch Single	TK10X40D	400	10	125	0.55	20	
		2SK3544	450	13	100	0.4	34	
		2SK3466	500	5	50	1.5	17	
		2SK3538	500	8	65	0.85	30	
		2SK3398	500	12	100	0.52	45	
		TK12X53D	525	12	150	0.58	25	
		2SK3438	600	10	80	1.0	28	
		TK12X60U	600	12	100	0.4	14	
 (mm)	N-ch Single	2SK2838	400	5.5	40	1.2	17	
		2SK2949	400	10	80	0.55	34	
		2SK3309	450	10	65	0.65	23	
		2SK3403	450	13	100	0.4	34	
		2SK2991	500	5	50	1.5	17	
		2SK3417 #	500	5	50	1.8	17	
		2SK2776	500	8	65	0.85	30	
		2SK3068	500	12	100	0.52	45	
		2SK2777	600	6	65	1.25	30	
		2SK3312	600	6	65	1.25	22	
		2SK2889	600	10	100	0.75	45	
		2SK3399	600	10	100	0.75	35	
		2SK3437	600	10	80	1.0	28	
		 (mm)	N-ch Single	2SK2841	400	10	80	0.55
2SK2542	500			8	80	0.85	30	
2SK3085	600			3.5	75	2.2	20	
2SK2866	600			10	125	0.75	45	
 (mm)	N-ch Single	2SK2679	400	5.5	35	1.2	17	
		2SK2952	400	8.5	40	0.55	34	
		2SK3310	450	10	40	0.65	23	
		2SK3743	450	13	40	0.4	34	
		2SK3313 #	500	12	40	0.62	45	
		2SK3265	700	10	45	1.0	53	

#: HSD type

- Contact the Toshiba sales representative for information about RoHS compliance before you purchase any components.

250 V < V_{DSS} ≤ 700 V (Power MOSFETs) (N-ch MOSFETs) (Continued)

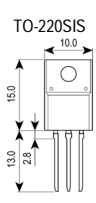
Package	Polarity	Part Number	V _{DSS} (V)	I _D (A)	P _D (W)	R _{DS(ON)} Max (Ω)	Q _g (nC) (typ.)	Internal Connections
						V _{GS} = 10 V		
	N-ch Single	2SK3757	450	2	30	2.45	9	
		2SK3766	450	2	30	2.45	8	
		TK5A45DA	450	4.5	30	1.75	9	
		TK6A45DA	450	5.5	35	1.35	11	
		TK7A45DA	450	6.5	35	1.2	11	
		TK8A45DA	450	7.5	35	1.1	12	
		TK8A45D	450	8	35	0.9	16	
		TK9A45D	450	9	40	0.77	16	
		2SK3869	450	10	40	0.68	28	
		TK11A45D	450	11	40	0.62	20	
		TK12A45D	450	12	45	0.52	24	
		TK13A45D	450	13	45	0.46	25	
		TK14A45DA	450	13.5	45	0.41	28	
		TK14A45D	450	14	45	0.34	38	
		TK16A45D	450	16	50	0.27	40	
		2SK3935	450	17	50	0.25	62	
		TK19A45D	450	19	50	0.25	45	
		TK4A50D	500	4	30	2.0	9	
		2SK3563	500	5	35	1.5	16	
		2SK3868 #	500	5	35	1.7	16	
		TK5A50D	500	5	35	1.5	11	
		TK5A50D5 #	500	5	35	2.1	11	
		TK6A50D	500	6	35	1.4	11	
		TK7A50D	500	7	35	1.22	12	
		TK7A50D5 #	500	7	35	1.68	12	
		TK8A50DA	500	7.5	35	1.04	16	
		2SK3561	500	8	40	0.85	28	
		2SK4042 #	500	8	40	0.97	28	
		TK8A50D	500	8	40	0.85	16	
		TK10A50D	500	10	45	0.72	20	
		TK11A50D	500	11	45	0.6	38	
		2SK3568	500	12	40	0.52	42	
		TK12A50D	500	12	45	0.52	25	
		TK12A50D5 #	500	12	45	0.73	30	
		TK13A50DA	500	12.5	45	0.47	28	
		2SK4012	500	13	45	0.4	50	
		TK13A50D	500	13	45	0.4	32	
		2SK3934	500	15	50	0.3	62	
		TK15A50D	500	15	50	0.3	40	
		TK18A50D	500	18	50	0.27	45	
		TK4A53D	525	4	35	1.7	11	
		TK5A53D	525	5	35	1.5	11	
		TK6A53D	525	6	35	1.3	12	
		TK12A53D	525	12	45	0.58	25	
		TK4A55DA	550	3.5	30	2.45	9	
		TK4A55D	550	4	35	1.88	11	
		TK5A55D	550	5	35	1.7	11	
		TK6A55DA	550	5.5	35	1.48	12	
		TK8A55DA	550	7.5	40	1.07	16	
		TK9A55DA	550	8.5	40	0.86	20	
		TK10A55D	550	10	45	0.72	24	
		TK11A55D	550	11	45	0.63	25	
		TK12A55D	550	12	45	0.57	28	
		TK13A55DA	550	12.5	45	0.48	38	
		TK14A55D	550	14	50	0.37	40	
		TK16A55D	550	16	50	0.33	45	
		2SK3767	600	2	25	4.5	9	
		TK3A60DA	600	2.5	30	2.8	9	
2SK3567	600	3.5	35	2.2	16			
TK4A60DA5 #	600	3.5	35	3.08	11			
TK4A60DA	600	3.5	35	2.2	11			
TK4A60DB	600	3.7	35	2	11			

#: HSD type

- Contact the Toshiba sales representative for information about RoHS compliance before you purchase any components.

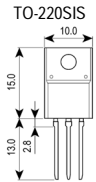
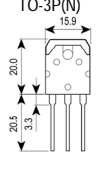
Package	Polarity	Part Number	V _{DSS} (V)	I _D (A)	P _D (W)	R _{DS(ON)} Max (Ω)	Q _g (nC) (typ.)	Internal Connections
						V _{GS} = 10 V		
 TO-220SIS (mm)	N-ch Single	TK4A60D	600	4	35	1.7	12	
		TK4A60D5 #	600	4	35	2.38	12	
		TK5A60D	600	5	35	1.43	16	
		2SK3562	600	6	40	1.25	28	
		2SK3947 #	600	6	40	1.4	28	
		TK6A60D	600	6	40	1.25	16	
		2SK3667	600	7.5	45	1.0	33	
		TK8A60DA	600	7.5	45	1.0	20	
		2SK3569	600	10	45	0.75	42	
		2SK4015 #	600	10	45	0.86	42	
		TK10A60D	600	10	45	0.75	25	
		TK10A60D5 #	600	10	45	1.0	25	
		TK11A60D	600	11	45	0.65	28	
		TK12A60D	600	12	45	0.55	38	
		TK12A60U	600	12	35	0.4	14	
		2SK3797	600	13	50	0.43	62	
		2SK4016 #	600	13	50	0.5	62	
		TK13A60D	600	13	40	0.43	40	
		TK15A60D	600	15	50	0.37	45	
		TK15A60U	600	15	40	0.30	17	
		TK20A60U	600	20	45	0.19	27	
		TK2A65D	650	2	30	3.26	9	
		TK3A65DA	650	2.5	35	2.51	11	
		TK3A65D	650	3	35	2.25	11	
		TK4A65DA	650	3.5	35	1.9	12	
		TK5A65DA	650	4.5	35	1.67	16	
		TK5A65D	650	5	40	1.43	16	
		TK6A65D	650	6	45	1.11	20	
		TK7A65D	650	7	45	0.98	24	
		TK8A65D	650	8	45	0.84	25	
		TK13A65U	650	13	40	0.38	17	
		TK17A65U	650	17	45	0.26	27	
 TO-3P(N) (mm)	N-ch Single	2SK3904	450	19	150	0.26	62	
		2SK2601	500	10	125	1.0	30	
		2SK3314 #	500	15	150	0.49	58	
		2SK4107	500	15	150	0.4	48	
		TK15J50D	500	15	210	0.4	32	
		2SK3905	500	17	150	0.31	62	
		2SK4108	500	20	150	0.27	62	
		TK20J50D	500	20	280	0.27	45	
		2SK3907	500	23	150	0.24	60	
		2SK3936 #	500	23	150	0.25	60	
		TK12J55D	550	12	190	0.57	28	
		TK16J55D	550	16	250	0.37	40	
		TK19J55D	550	19	280	0.33	45	
		2SK2602	600	6	125	1.25	30	
		2SK2699	600	12	150	0.65	58	
		TK12J60U	600	12	144	0.4	14	
		2SK3903	600	14	150	0.44	62	
		TK15J60T	600	15	170	0.30	21	
		TK15J60U	600	15	170	0.3	17	
		2SK3906 #	600	20	150	0.33	60	
		2SK3911	600	20	150	0.30	60	
		TK20J60T	600	20	190	0.19	30	
		TK20J60U	600	20	190	0.19	27	
		TK40J60T	600	40	400	0.08	67	
		TK40J60U	600	40	320	0.08	55	
		TK50J60U	600	50	400	0.065	67	
		TK13J65U	650	13	170	0.38	17	
		TK17J65U	650	17	190	0.26	27	

#: HSD type

- Contact the Toshiba sales representative for information about RoHS compliance before you purchase any components.

250 V < V_{DSS} ≤ 700 V (Power MOSFETs) (N-ch MOSFETs) (Continued)

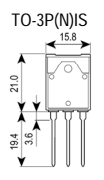
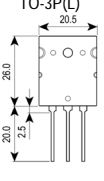
Package	Polarity	Part Number	V _{DSS} (V)	I _D (A)	P _D (W)	R _{DS(ON)} Max (Ω)	Q _g (nC) (typ.)	Internal Connections
 <p>TO-3P(N)IS (mm)</p>	N-ch Single	2SK2916	500	14	80	0.4	58	
		2SK2917	500	18	90	0.27	80	
		2SK2953	600	15	90	0.4	80	
		TK40M60U	600	40	90	0.08	55	
		2SK3453	700	10	80	1.0	53	
 <p>TO-3P(L) (mm)</p>	N-ch Single	2SK1486	300	32	200	0.095	140	
		2SK1544	500	25	200	0.2	150	
		2SK3131 #	500	50	250	0.11	280	
		2SK3132	500	50	250	0.095	280	

#: HSD type

- Contact the Toshiba sales representative for information about RoHS compliance before you purchase any components.

700 V < V_{DSS} (Power MOSFETs) (N-ch MOSFETs)

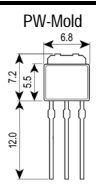
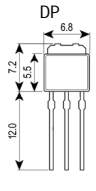
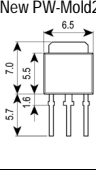
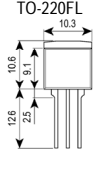
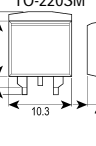
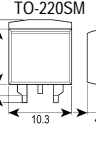
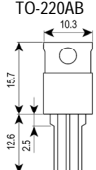
Package	Polarity	Part Number	V _{DSS} (V)	I _D (A)	P _D (W)	R _{DS(ON)} Max (Ω)	Q _g (nC) (typ.)	Internal Connections
						V _{GS} = 10 V		
 (mm)	N-ch Single	2SK3301	900	1	20	20	6	
 (mm)	N-ch Single	2SK2845	900	1	40	9.0	15	
 (mm)	N-ch Single	TK1Q90A	900	1	20	9.0	13	
 (mm)  (mm)	N-ch Single	2SK2883	800	3	75	3.6	25	
		2SK2884	800	5	100	2.2	34	
		2SK1930	1000	4	80	3.8	60	
 (mm)	N-ch Single	2SK3879	800	6.5	80	1.7	35	
 (mm)	N-ch Single	2SK2603	800	3	100	3.6	25	
		2SK2733	900	1	60	9.0	15	
		2SK2608	900	3	100	4.3	25	
		2SK1119	1000	4	100	3.8	60	

• Contact the Toshiba sales representative for information about RoHS compliance before you purchase any components.

700 V < V_{DSS} (Power MOSFETs) (N-ch MOSFETs) (Continued)

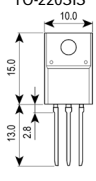
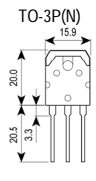
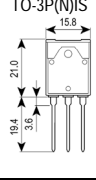
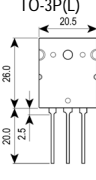
Package	Polarity	Part Number	V _{DSS} (V)	I _D (A)	P _D (W)	R _{DS(ON)} Max (Ω)	Q _g (nC) (typ.)	Internal Connections
						V _{GS} = 10 V		
 TO-220SIS (mm)	N-ch Single	2SK4013	800	6	45	1.7	45	
		2SK3566	900	2.5	40	6.4	12	
		2SK3564	900	3	40	4.3	17	
		2SK3798	900	4	40	3.5	26	
		2SK3565	900	5	45	2.5	28	
		2SK3742	900	5	45	2.5	25	
		2SK4014	900	6	45	2.0	45	
 TO-3P(N) (mm)	N-ch Single	2SK3633	800	7	150	1.7	35	
		2SK2607	800	9	150	1.2	68	
		2SK2719	900	3	125	4.3	25	
		2SK3700	900	5	150	2.5	28	
		2SK4115	900	7	150	2.0	45	
		2SK3473	900	9	150	1.6	38	
		2SK3878	900	9	150	1.3	62	
		2SK2968	900	10	150	1.25	70	
		2SK4207	900	13	150	0.95	45	
		2SK1359	1000	5	125	3.8	60	
		2SK2613	1000	8	150	1.7	65	
 TO-3P(N)IS (mm)	N-ch Single	2SK3880	800	6.5	80	1.7	35	
		2SK2606	800	8	85	1.2	68	
		2SK2847	900	8	85	1.4	58	
		2SK3017	900	8.5	90	1.25	70	
		2SK1365	1000	7	90	1.8	120	
 TO-3P(L) (mm)	N-ch Single	2SK1489	1000	12	200	1.0	110	

• Contact the Toshiba sales representative for information about RoHS compliance before you purchase any components.

VDSS ≤ 60 V (Power MOSFETs) (P-ch MOSFETs)

Package	Polarity	Part Number	VDSS (V)	VGS (V)	ID (A)	RDS(ON) Max (mΩ)						Ciss (pF)	Internal FET	Internal Connections
						VGS = 1.2 V	VGS = 1.5 V	VGS = 1.8 V	VGS = 2.5 V	VGS = 4.0 V	VGS = 4.5 V			
 CST3B Bottom View (mm)	P-ch	SSM3J46CTB **	-20	±8	-2	—	250	178	133	—	103	290	—	(4)
 ES6 (mm)	P-ch	SSM6J212FE *	-20	±8	-3.3	—	94	65.4	49	—	40.7	970	—	(2)
		SSM6J53FE	-20	±8	-1.8	—	364	204	136	—	—	568	—	(2)
		SSM6J206FE	-20	±8	-2.0	—	—	320	186	130	—	335	—	(2)
		SSM6J205FE	-20	±8	-0.8	—	—	460	306	234	—	250	—	(2)
		SSM6J26FE	-20	±8	-0.5	—	—	980	330	230	—	250	—	(2)
		SSM6J23FE	-12	±8	-1.2	—	—	—	210	160	—	420	—	(2)
		SSM6J25FE	-20	±12	-0.5	—	—	—	430	260	—	218	—	(2)
 SSM6J207FE (mm)	P-ch + P-ch	SSM6P41FE *	-20	±8	-0.72	—	1040	670	440	—	300	110	—	(1)
 UFM (mm)	P-ch	SSM3J132TU **	-12	±6	-5.4	94	39	29	21	—	17	2700	—	(3)
		SSM3J130TU *	-20	±8	-4.4	—	63.2	41.1	31.0	—	25.8	1800	—	(3)
		SSM3J120TU	-20	±8	-4.0	—	140	78	49	38	—	1484	—	(3)
		SSM3J129TU *	-20	±8	-4.6	—	137	88	62	—	46	640	—	(3)
		SSM3J115TU	-20	±8	-2.2	—	353	193	125	98	—	568	—	(3)
		SSM3J114TU	-20	±8	-1.8	—	526	321	199	149	—	331	—	(3)
		SSM3J113TU	-20	±12	-1.7	—	—	449 (@2.0 V)	249	169	—	370	—	(3)
		SSM3J111TU	-20	±12	-1.0	—	—	—	680	480	—	160	—	(3)
		SSM3J117TU	-30	±20	-2.0	—	—	—	—	225	—	280	—	(3)
		SSM3J118TU	-30	±20	-1.4	—	—	—	—	480	—	137	—	(3)
 SSM3J112TU (mm)	P-ch	SSM3J112TU	-30	±20	-1.1	—	—	—	—	790	—	86	—	(3)
 UF6 (mm)	P-ch	SSM6J409TU *	-20	±8	-9.5	—	72.3	46.2	30.2	—	22.1	1100	—	(2)
		SSM6J412TU *	-20	±8	-4.0	—	99.6	67.8	51.4	—	42.7	840	—	(2)
		SSM6J51TU	-12	±8	-4.0	—	150	85	54	—	—	1700	—	(2)
		SSM6J21TU	-12	±12	-3.0	—	—	—	88	50	—	1300	—	(2)
		SSM6J50TU	-20	±10	-2.5	—	—	205 (@2.0 V)	100	—	64	800	—	(2)
		SSM6J401TU	-30	±20	-2.5	—	—	—	—	145	—	730	—	(2)
		SSM6J402TU	-30	±20	-2.0	—	—	—	—	225	—	280	—	(2)
		SSM6J410TU *	-30	±20	-2.1	—	—	—	—	393	—	120	—	(2)
		SSM6P54TU	-20	±8	-1.2	—	555	350	228	—	—	331	—	(1)
		SSM6P39TU	-20	±8	-1.5	—	—	430	294	213	—	250	—	(1)
 SSM6P28TU (mm)	P-ch x 2	SSM6P28TU	-20	±8	-0.8	—	—	460	306	234	—	250	SSM6J205FE x 2	(1)
		SSM6P26TU	-20	±8	-0.5	—	—	980	330	230	—	250	SSM6J26FE x 2	(1)
		SSM6P25TU	-20	±12	-0.5	—	—	—	430	260	—	218	SSM6J25FE x 2	(1)
		SSM6P40TU	-30	±20	-1.4	—	—	—	—	403	—	120	—	(1)
 US6 (mm)	Pch	SSM6J08FU	-20	±12	-1.3	—	—	460 (@2.0 V)	260	180	—	370	—	(2)
		SSM6J06FU	-20	±12	-0.65	—	—	—	700	500	—	160	—	(2)
		SSM6J07FU	-30	±20	-0.8	—	—	—	—	800	—	130	—	(2)
 UDFN6 (mm)	P-ch x 2	SSM6P47NU	-20	±8	-4	—	242	170	125	—	95	290	—	(6)
		SSM6J501NU	-20	±8	-10	—	48	33	25	—	20	2300	—	(5)
	P-ch	SSM6J502NU	-20	±8	-6	—	63.2	41.1	31	—	25.8	1800	—	(5)
		SSM6J503NU	-20	±8	-6	—	80.4	56	39.7	—	29.8	840	—	(5)

• Contact the Toshiba sales representative for information about RoHS compliance before you purchase any components.

*: New product
**: Under development

◆Internal Connections

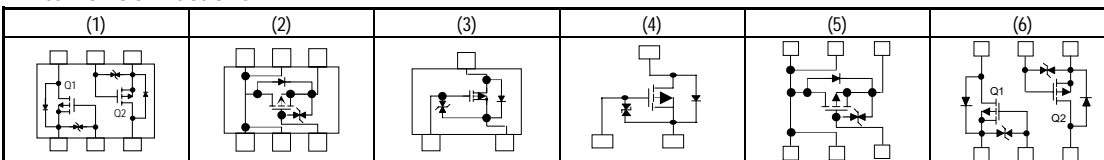

◆The internal connection diagrams only show the general configurations of the circuits.

V_{DS} ≤ 60 V (Power MOSFETs) (P-ch MOSFETs) (Continued)

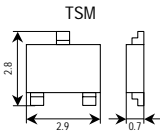
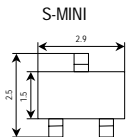
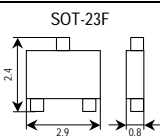
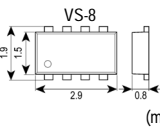
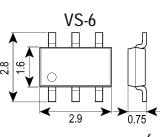
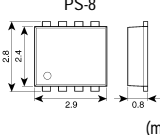
Package	Polarity	Part Number	V _{DS} (V)	V _{GSS} (V)	I _D (A)	P _D (W)	R _{DS(ON)} Max (mΩ)								C _{iss} (pF)	Q _g (nC) (typ.)	Internal Connections
							V _{GS} = 1.5 V	V _{GS} = 1.8 V	V _{GS} = 2.0 V	V _{GS} = 2.5 V	V _{GS} = 4 V	V _{GS} = 4.5 V	V _{GS} = 7 V	V _{GS} = 10 V			
 (mm)	P-ch	SSM3J307T	-20	±8	-5	1.25	83	56	—	40	—	31	—	—	1170	19	(6)
		SSM3J321T	-20	±8	-5.2	1.25	137	88	—	62	—	46	—	—	640	8.1	(6)
		SSM3J326T *	-30	±12	-5.6	1.25	—	115	—	62.5	—	45.7	—	—	650	9.3	(6)
		SSM3J312T	-12	±8	-2.7	1.25	—	237	—	142	91	—	—	—	550	7.5	(6)
		SSM3J313T	-20	±8	-1.6	0.7	—	640	—	396	268	—	—	—	170	3.3	(6)
		SSM3J01T	-30	±10	-1.7	1.25	—	—	—	600	400	—	—	—	240	—	(6)
		SSM3J02T	-30	±10	-1.5	1.25	—	—	—	700	500	—	—	—	150	—	(6)
		SSM3J314T	-30	±20	-3.5	0.7	—	—	—	—	100	—	—	—	505	11.5	(6)
		SSM3J14T	-30	±20	-2.7	1.25	—	—	—	—	170	—	—	—	413	—	(6)
		SSM3J306T	-30	±20	-2.4	0.7	—	—	—	—	225	—	—	—	280	2.5	(6)
SSM3J305T	-30	±20	-1.7	0.7	—	—	—	—	477	—	—	—	137	1.3	(6)		
 (mm)	P-ch	SSM3J325F *	-20	±8	-2	1.2	311	231	—	179	—	150	—	—	—	(6)	
 (mm)	P-ch	SSM3J328R *	-20	±8	-6	2	88.4	56	—	39.7	—	29.8	—	—	840	12.8	(6)
		SSM3J327R *	-20	±8	-3.9	2	240	168	—	123	—	93	—	—	290	—	(6)
		SSM3J332R *	-30	±12	-6	2	—	145	—	77	—	55	—	47	506	7.3	(6)
		SSM3J334R *	-30	±20	-3.5	2	—	—	—	—	—	121.3	—	86.3	266	3.7	(6)
 (mm)	P-ch Single	TPCF8101	-12	±8	-6	2.5	—	85	—	40	—	28	—	—	18	(2)	
		TPCF8103	-20	±8	-2.7	2.5	—	300	—	160	—	110	—	—	6	(2)	
		TPCF8105	-20	±12	-6	2.5	—	100	—	45	—	31	—	—	17	(2)	
		TPCF8108	-20	±12	-7	2.5	—	95	—	37	—	26	—	—	1320	19	(2)
	P-ch Dual	TPCF8107	-30	-25/+20	-6	2.5	—	—	—	—	—	38	—	28	970	22	(2)
		TPCF8301	-20	±8	-2.7	1.35	—	300	—	160	—	110	—	—	6	(3)	
		TPCF8305	-20	±12	-4	1.35	—	265	160	83	—	58	—	—	680	9.2	(3)
		TPCF8304	-30	±20	-3.2	1.35	—	—	—	—	—	105	—	72	—	14	(3)
 (mm)	P-ch Single	TPC6103	-12	±8	-5.5	2.2	—	90	—	55	—	35	—	—	20	(1)	
		TPC6105	-20	±8	-2.7	2.2	—	300	—	160	—	110	—	—	6	(1)	
		TPC6113	-20	±12	-5	2.2	—	—	—	85	—	55	—	—	690	10	(1)
		TPC6111	-20	±8	-5.5	2.2	—	80	—	57	—	40	—	—	10	(1)	
		TPC6110	-30	-25/+20	-4.5	2.2	—	—	—	—	—	77	—	56	—	14	(1)
		TPC6109-H	-30	±20	-5	2.2	—	—	—	—	—	83	—	59	—	12.6	(1)
 (mm)	P-ch Single	TPCP8101	-20	±8	-5.6	1.68	—	90	—	41	—	30	—	—	19	(4)	
		TPCP8102	-20	±12	-7.2	1.68	—	—	80	30	—	18	—	—	33	(4)	
		TPCP8103-H	-40	±20	-4.8	1.68	—	—	—	—	—	54	—	40	—	19	(4)
	P-ch Dual	TPCP8303	-20	±8	-3.8	1.48	144	90	—	60	—	46	—	—	10	(3)	
		TPCP8306	-20	±12	-4	1.48	—	265	160	83	—	58	—	—	680	9.2	(3)
TPCP8305	-20	±12	-6	1.48	—	—	—	—	42	—	30	—	—	1500	21.5	(3)	

• Contact the Toshiba sales representative for information about RoHS compliance before you purchase any components.

*: New product

◆ Internal Connections

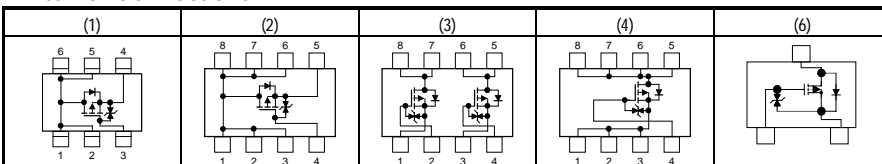

Note: Some MOSFETs do not have a Zener diode between gate and source.

◆ The internal connection diagrams only show the general configurations of the circuits.

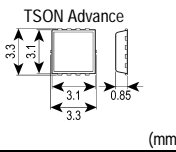
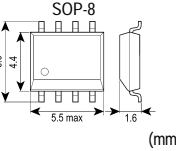
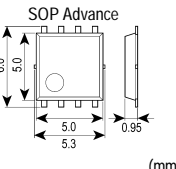
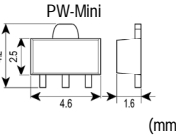
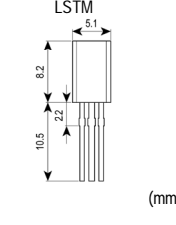
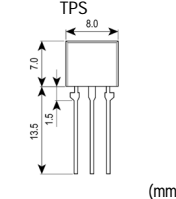
Package	Polarity	Part Number	V _{DSS} (V)	V _{GSS} (V)	I _D (A)	P _D (W)	R _{DS(ON)} Max (mΩ)								Q _g (nC) (typ.)	Internal Connections
							V _{GS} = 1.8 V	V _{GS} = 2.0 V	V _{GS} = 2.5 V	V _{GS} = 4 V	V _{GS} = 4.5 V	V _{GS} = 7 V	V _{GS} = 10 V			
 (mm)	P-ch Single	TPCC8102	-30	±20	-15	26	—	—	—	33.2	—	—	18.9	26	(1)	
		TPCC8103	-30	±20	-18	27	—	—	—	25	—	—	12	38	(1)	
		TPCC8104	-30	-25/+20	-20	27	—	—	—	—	12.4	—	8.8	58	(1)	
		TPCC8105	-30	-25/+20	-23	30	—	—	—	—	10.4	—	7.8	76	(1)	
 (mm)	P-ch Single	TPC8115	-20	±8	-10	1.9	300	—	14	—	10	—	—	115	(1)	
		TPC8119	-30	±20	-10	1.9	—	—	—	28	—	—	13	40	(1)	
		TPC8125	-30	-25/+20	-10	1.9	—	—	—	—	17	—	13	64	(1)	
		TPC8121	-30	±20	-10	1.9	—	—	—	24	—	—	12	42	(1)	
		TPC8126	-30	-25/+20	-11	1.9	—	—	—	14	—	—	10	56	(1)	
		TPC8123	-30	-25/+20	-11	1.9	—	—	—	12.5	—	—	9	68	(1)	
		TPC8122	-30	±20	-12	1.9	—	—	—	16.5	—	—	8	62	(1)	
		TPC8118	-30	±20	-13	1.9	—	—	—	15	—	—	7	65	(1)	
		TPC8127	-30	-25/+20	-13	1.9	—	—	—	—	8.9	—	6.5	92	(1)	
		TPC8128	-30	-25/+20	-16	1.9	—	—	—	—	6.9	—	5	115	(1)	
		TPC8117	-30	±20	-18	1.9	—	—	—	7.9	—	—	3.9	130	(1)	
		TPC8120	-30	-25/+20	-18	1.9	—	—	—	—	42	—	3.2	180	(1)	
		TPC8116-H	-40	±20	-7.5	1.9	—	—	—	—	37	—	30	27	(1)	
TPC8110	-40	±20	-8	1.9	—	—	—	35	—	—	25	48	(1)			
TPC8124	-40	-25/+20	-12	1.9	—	—	—	—	10	—	8	104	(1)			
 (mm)	P-ch Single	TPCA8105	-12	±8	-6	20	92	—	51	—	33	—	—	18	(1)	
		TPCA8109	-30	-25/+20	-12	30	—	—	—	—	13	—	9	56	(1)	
		TPCA8128	-30	-25/+20	-34	45	—	—	—	—	6.7	—	4.8	115	(1)	
		TPCA8106	-30	±20	-40	45	—	—	—	7.8	—	—	3.7	130	(1)	
		TPCA8120	-30	-25/+20	-45	45	—	—	—	—	3.0	—	4	190	(1)	
		TPCA8107-H	-40	±20	-7.5	30	—	—	—	—	37	—	30	27	(1)	
		TPCA8108	-40	±20	-40	45	—	—	—	—	—	—	9.5	100	(1)	
TPCA8104	-60	±20	-40	45	—	—	—	24	—	—	16	90	(1)			
 (mm)	P-ch Single	2SJ360	-60	—	-1	1.5	—	—	—	1200	—	—	730	6.5		
		2SJ508	-100	—	-1	1.5	—	—	—	2500	—	—	1900	6.3		
 (mm)	P-ch Single	2SJ537	-50	—	-5	0.9	—	—	—	340	—	—	190	18		
		2SJ507	-60	—	-1	0.9	—	—	—	1000	—	—	700	5.6		
		2SJ509	-100	—	-1	0.9	—	—	—	2500	—	—	1900	6.3		
 (mm)	P-ch Single	2SJ378	-60	—	-5	1.3	—	—	—	280	—	—	190	22		
		2SJ669	-60	—	-5	1.2	—	—	—	250	—	—	170	15		

• Contact the Toshiba sales representative for information about RoHS compliance before you purchase any components.

◆Internal Connections

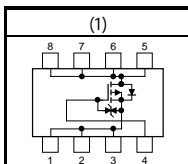

Note: Some MOSFETs do not have a Zener diode between gate and source.

◆The internal connection diagrams only show the general configurations of the circuits.

V_{DS} ≤ 60 V (Power MOSFETs) (P-ch MOSFETs) (Continued)

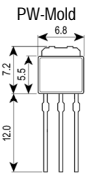
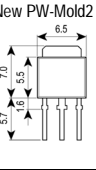
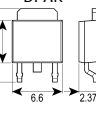
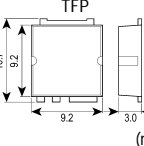
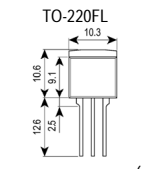
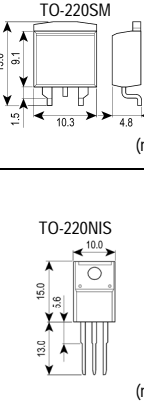
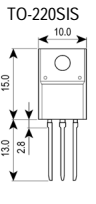
Package	Polarity	Part Number	V _{DS} (V)	V _{GSS} (V)	I _D (A)	P _D (W)	R _{DS(ON)} Max (mΩ)								Q _g (nC) (typ.)	Internal Connections	
							V _{GS} = 1.8 V	V _{GS} = 2.0 V	V _{GS} = 2.5 V	V _{GS} = 4 V	V _{GS} = 4.5 V	V _{GS} = 6 V	V _{GS} = 7 V	V _{GS} = 10 V			
 PW-Mold (mm)	P-ch Single	2SJ439	-16	—	-5	20	—	—	280	200	—	—	—	—	24		
		2SJ668	-60	—	-5	20	—	—	—	250	—	—	—	—	170	15	
		2SJ338	-180	—	-1	20	—	—	—	—	—	—	—	—	5000	—	
		2SJ567	-200	—	-2.5	20	—	—	—	—	—	—	—	—	2000	10	
		2SJ610	-250	—	-2	20	—	—	—	—	—	—	—	—	2550	24	
 New PW-Mold2 (mm)	P-ch Single	2SJ680	-200	—	-2.5	20	—	—	—	—	—	—	—	2000	10		
 DPAK (mm)	P-ch Single	TJ15P04M3	-40	±20	15	29	—	—	—	—	48	—	—	36	24		
 TFP (mm)	P-ch Single	TJ80X04M3L	-40	+10/-20	-80	150	—	—	—	—	—	5.9	—	3.9	250		
		TJ80X06M3L	-60	+10/-20	-80	150	—	—	—	—	—	—	11.4	—	7.6	250	
		2SJ619	-100	—	-16	75	—	—	—	320	—	—	—	—	210	48	
		2SJ620	-100	—	-18	125	—	—	—	120	—	—	—	—	90	140	
 TO-220FL (mm)	P-ch Single	2SJ312	-60	—	-14	40	—	—	—	190	—	—	—	—	120	45	
		2SJ401	-60	—	-20	100	—	—	—	90	—	—	—	—	45	90	
		2SJ402	-60	—	-30	100	—	—	—	60	—	—	—	—	38	110	
		2SJ412	-100	—	-16	60	—	—	—	320	—	—	—	—	210	48	
 TO-220NIS (mm)	P-ch Single	2SJ438	-60	—	-5	25	—	—	—	280	—	—	—	—	190	22	
		2SJ304	-60	—	-14	40	—	—	—	190	—	—	—	—	120	45	
		2SJ349	-60	—	-20	35	—	—	—	90	—	—	—	—	45	90	
		2SJ334	-60	—	-30	45	—	—	—	60	—	—	—	—	38	110	
		2SJ380	-100	—	-12	35	—	—	—	320	—	—	—	—	210	48	
		2SJ464	-100	—	-18	45	—	—	—	120	—	—	—	—	90	140	
		2SJ313	-180	—	-1	25	—	—	—	—	—	—	—	—	5000	—	
		2SJ407	-200	—	-5	30	—	—	—	—	—	—	—	—	1000	20	
		2SJ512	-250	—	-5	30	—	—	—	—	—	—	—	—	1250	22	
2SJ516	-250	—	-6.5	35	—	—	—	—	—	—	—	—	800	29			
 TO-220SIS (mm)	P-ch Single	TJ70A06J3	-60	—	-70	54	—	—	—	—	10	—	—	8	246		
		TJ9A10M3	-100	±20	9	19	—	—	—	—	—	—	—	—	170	47	
		TJ11A10M3	-100	±20	-11	24	—	—	—	—	—	—	—	—	130	69	
		TJ20A10M3	-100	—	-20	35	—	—	—	—	—	—	—	—	90	120	

• Contact the Toshiba sales representative for information about RoHS compliance before you purchase any components.

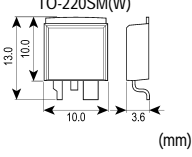
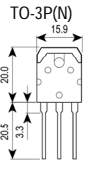
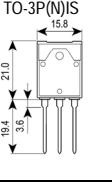
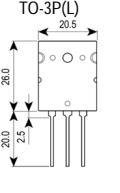
Package	Polarity	Part Number	V _{DSS} (V)	I _D (A)	P _D (W)	R _{DS(ON)} Max (mΩ)								Q _g (nC) (typ.)	Internal Connections
						V _{GS} = 1.8 V	V _{GS} = 2.0 V	V _{GS} = 2.5 V	V _{GS} = 4 V	V _{GS} = 4.5 V	V _{GS} = 6 V	V _{GS} = 7 V	V _{GS} = 10 V		
 <p>TO-220SM(W) (mm)</p>	P-ch Single	TJ100F04M3L	-40	-100	250	—	—	—	—	—	5.4	—	3.6	250	
		TJ150F04M3L	-40	-150	300	—	—	—	—	—	4.2	—	2.8	390	
		TJ120F06J3	-60	-120	300	—	—	—	—	—	—	—	8	258	
		TJ150F06M3L	-60	-150	300	—	—	—	—	—	6.1	—	5.6	420	
 <p>TO-3P(N) (mm)</p>	P-ch Single	2SJ200	-180	-10	120	—	—	—	—	—	—	830	—		
		2SJ618	-180	-10	130	—	—	—	—	—	—	370	—	35	
 <p>TO-3P(N)IS (mm)</p>	P-ch Single	2SJ440	-180	-9	80	—	—	—	—	—	—	830	—		
 <p>TO-3P(L) (mm)</p>	P-ch Single	2SJ201	-200	-12	150	—	—	—	—	—	—	625	—		

• Contact the Toshiba sales representative for information about RoHS compliance before you purchase any components.

V_{DSS} ≤ 60 V (Power MOSFETs) (Complementary MOSFETs)

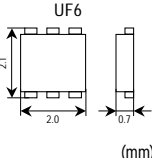
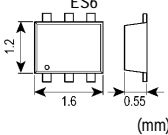
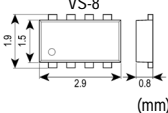
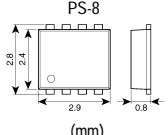
Package	Polarity	Part Number	V _{DSS} (V)	V _{GSS} (V)	I _D (A)	R _{DS(on)} Max (mΩ)						C _{iss} (pF)	Q _g (nC) (typ.)	Internal FET	Internal Connections																												
						V _{GS} = 1.5 V	V _{GS} = 1.8 V	V _{GS} = 2.5 V	V _{GS} = 4.0 V	V _{GS} = 4.5 V	V _{GS} = 10 V																																
 (mm)	N-ch + P-ch	SSM6L39TU	20	±10	1.6	247	190	139	119	—	—	265	—	SSM6N39TU	(1)																												
			-20	±8	-1.5	—	430	294	213	—	—	250	—	+ SSM6P39TU	(1)																												
		SSM6L13TU	20	±12	0.8	—	235	178	143	—	—	268	—	SSM3K102TU	(1)																												
			-20	±8	-0.8	—	460	306	234	—	—	250	—	+ SSM3J108TU	(1)																												
		SSM6L10TU	20	±12	0.5	—	395	190	145	—	—	268	—	SSM6K25FE	(1)																												
			-20	±8	-0.5	—	980	330	230	—	—	250	—	+ SSM6J26FE	(1)																												
		SSM6L11TU	20	±12	0.5	—	395	190	145	—	—	268	—	SSM6K25FE	(1)																												
			-20	±12	-0.5	—	—	430	260	—	—	218	—	+ SSM6J25FE	(1)																												
		SSM6L12TU	30	±12	0.5	—	—	180	145	—	—	245	—	SSM6K24FE	(1)																												
			-20	±12	-0.5	—	—	430	260	—	—	218	—	+ SSM6J25FE	(1)																												
SSM6L40TU	30	±20	1.6	—	—	—	182	—	—	180	—	SSM6N40TU	(1)																														
	-30	±20	-1.4	—	—	—	403	—	—	120	—	+ SSM6P40TU	(1)																														
SSM6E03TU	20	±10	0.1	15 Ω	—	4.0 Ω	3.0 Ω	—	—	9.3	—	SSM3K16FU	(2)																														
	-20	±8	-1.8	—	335	180	144	—	—	335	—	SSM3J109TU	(2)																														
SSM6E02TU	20	±10	0.1	15 Ω	—	4.0 Ω	3.0 Ω	—	—	9.3	—	SSM3K16FU	(3)																														
	-20	±8	-1.8	364	204	136	—	—	—	568	—	—	(3)																														
SSM6E01TU	20	±10	0.05	—	—	10 Ω	—	—	—	11	—	SSM3K04FE	(3)																														
	-12	±12	-1	—	—	240	160	—	—	310	—	—	(4)																														
 (mm)	N-ch + P-ch	SSM6L14FE	20	±10	-0.8	600	450	330	—	240	—	90	2.0	SSM6N42FE	(1)																												
			-20	±8	-0.72	1040	670	440	—	300	—	110	1.76	SSM6P41FE	(1)																												
 (mm)	N-ch + P-ch	TPCF8402	30/-30	±20/±20	4/-3.2	1.35	—	—	77/105	—	50/72	—	10/14	—	(4)																												
 (mm)	N-ch + P-ch	TPCP8404	30/-30	±20/±20	4/-4	1.48	—	—	—	80/80	50/50	—	4.6/13	—	(4)																												
																TPCP8403	40/-40	±20/±20	4.7/-3.4	1.48	—	—	—	60/105	40/70	—	16/15	—	(4)														
																														TPCP8405	30/-30	±20/±20	6/-4.5	1.48	—	—	—	29/42	26/31.3	—	13.8/24.1	—	(4)

• Contact the Toshiba sales representative for information about RoHS compliance before you purchase any components.

◆ Internal Connections

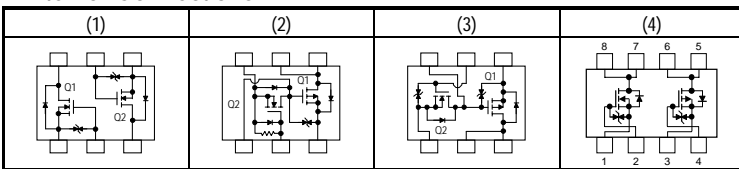

Note: Some MOSFETs do not have a Zener diode between gate and source.

◆ The internal connection diagrams only show the general configurations of the circuits.

(Load SW)

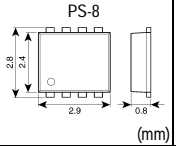
Package	Polarity	Part Number	V _{DSS} (V)	V _{GSS} (V)	I _D (A)	P _D (W)	R _{DS(ON)} Max (mΩ)								C _{iss} (pF)	Q _g (nC) (typ.)	Internal Connections
							V _{GS} = 1.5 V	V _{GS} = 1.8 V	V _{GS} = 2.0 V	V _{GS} = 2.5 V	V _{GS} = 4V	V _{GS} = 4.5 V	V _{GS} = 7V	V _{GS} = 10 V			
 PS-8 (mm)	Load SW	TPCP8401	-12	±8	-5.5	1.96	—	103	—	58	—	38	—	—	—	20	(1)

• Contact the Toshiba sales representative for information about RoHS compliance before you purchase any components.

(MOSFET + BipTr)

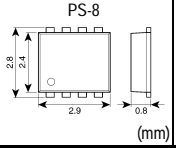
Package	Polarity	Part Number	V _{DSS} (V)	V _{GSS} (V)	I _D (A)	P _D (W)	R _{DS(ON)} Max (mΩ)								C _{iss} (pF)	Q _g (nC) (typ.)	Internal Connections
							V _{GS} = 1.5 V	V _{GS} = 1.8 V	V _{GS} = 2.0 V	V _{GS} = 2.5 V	V _{GS} = 4V	V _{GS} = 4.5 V	V _{GS} = 7V	V _{GS} = 10 V			
 PS-8 (mm)	P-ch + BipTr	TPCP8J01	-32	±20	-5.5	2.14	—	—	—	—	49	—	—	35	—	34	(2)

• Contact the Toshiba sales representative for information about RoHS compliance before you purchase any components.

◆Internal Connections

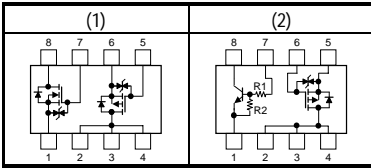

Note: Some MOSFETs do not have a Zener diode between gate and source.

◆The internal connection diagrams only show the general configurations of the circuits.

(MOSFET + SBD)

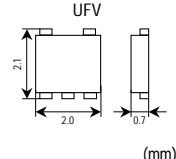
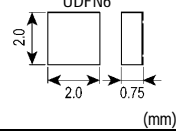
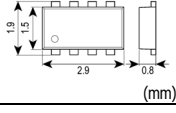
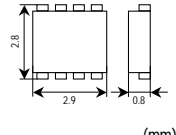
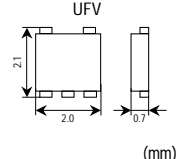
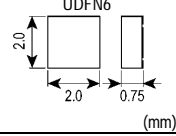
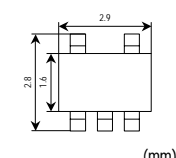
Package	Polarity	Part Number	MOSFET										SBD				Qg (nC) (typ.)	Internal Connections				
			V _{DSS} (V)	V _{GSS} (V)	I _D (A)	P _D (W)	R _{DS(ON)} Max (mΩ)						C _{iss} (pF)	V _R (V)	I _o (A)	V _F Max (V)						
							V _{GS} = 1.8 V	V _{GS} = 2.0 V	V _{GS} = 2.5 V	V _{GS} = 4.0 V	V _{GS} = 4.5 V	V _{GS} = 10 V				I _F = 1.0 A			I _F = 0.5 A	I _F = 0.3 A	I _F = 0.1 A	
 (mm)	Pch + SBD	SSM5G10TU	-20	±8	-1.5	—	430	—	294	213	—	—	250	20	0.7	—	0.39	—	—	—	(1)	
		SSM5G09TU	-12	±8	-1.5	—	—	—	200	130	—	—	550	12	0.5	—	0.43	0.39	—	—	(1)	
		SSM5G02TU	-12	±12	-1	—	—	—	240	160	—	—	310	12	0.5	—	0.43	0.39	—	—	(1)	
		SSM5G04TU	-12	±12	-1	—	—	—	420	240	—	—	170	12	0.5	—	0.43	0.39	—	—	(1)	
		SSM5G11TU	-30	±20	-1.4	—	—	—	—	403	—	—	226	120	30	0.7	—	0.41	—	—	—	(1)
		SSM5G01TU	-30	±20	-1	—	—	—	—	800	—	—	400	86	20	0.5	—	—	0.45	—	—	(1)
 (mm)	Pch + SBD	SSM6G13NU	-20	±8	2	2	265	—	186	—	133	—	260	30	1	0.59	0.45	—	—	3.6	(5)	
 (mm)		TPCF8B01	-20	±8	-2.7	1.35	300	—	160	—	110	—	—	20	1	0.49	—	—	—	6	(4)	
 (mm)		TPCP8BA1	-20	±12	-1.3	—	—	—	260	180	—	—	370	25	0.7	—	0.41	—	—	—	(2)	
 (mm)	Nch + SBD	SSM5H10TU	20	±10	1.6	—	190	—	139	119	—	—	260	20	0.7	—	0.39	—	—	—	(3)	
		SSM5H05TU	20	±12	1.5	—	—	—	220	160	—	—	125	12	0.5	—	0.43	0.39	—	—	(3)	
		SSM5H08TU	20	±12	1.5	—	—	—	220	160	—	—	125	20	0.5	—	—	0.45	—	—	(3)	
		SSM5H03TU	12	±12	1.4	—	—	—	—	300	—	150	125	12	0.5	—	0.43	0.39	—	—	(3)	
		SSM5H11TU	30	±20	1.6	—	—	—	—	182	—	122	180	30	0.7	—	0.41	—	—	—	(3)	
		SSM5H16TU	30	±12	1.9	—	296	—	177	133	—	—	123	30	0.8	—	0.45	—	0.36	—	(3)	
		SSM5H01TU	30	±20	1.4	—	—	—	—	450	—	200	106	20	0.5	—	—	0.45	—	—	(3)	
		SSM5H07TU	20	±20	1.2	—	—	—	—	540	—	300	36	12	0.5	—	0.43	0.39	—	—	(3)	
 (mm)	Nch + SBD	SSM6H15NU	30	±10	4	2	124	71	—	—	56	—	280	30	1	0.5	0.41	—	—	2.8	(6)	
 (mm)		SSM5H14F	30	±12	3	—	138	—	94	78	—	—	270	45	0.1	—	—	—	0.6	—	(3)	

• Contact the Toshiba sales representative for information about RoHS compliance before you purchase any components.

◆Internal Connections

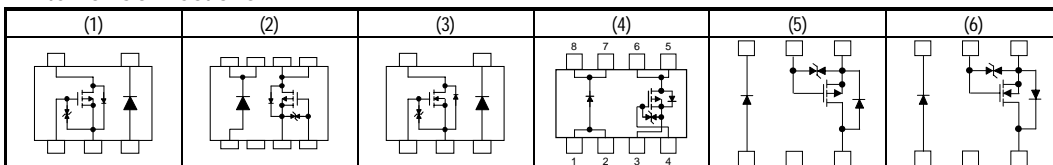

Note: Some MOSFETs do not have a Zener diode between gate and source.

◆The internal connection diagrams only show the general configurations of the circuits.

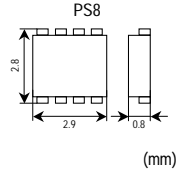
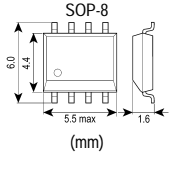
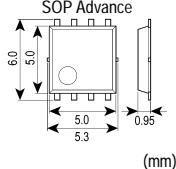
Package	Polarity	Part Number	MOSFET										SBD				Qg (nC) (typ.)	Internal Connections					
			V _{DSS} (V)	V _{GSS} (V)	I _D (A)	P _D (W)	R _{DS(ON)} Max (mΩ)						C _{iss} (pF)	V _R (V)	I _O (A)	V _F Max (V)							
							V _{GS} = 1.8 V	V _{GS} = 2.0 V	V _{GS} = 2.5 V	V _{GS} = 4.0 V	V _{GS} = 4.5 V	V _{GS} = 10 V				I _F = 1.0 A			I _F = 0.5 A	I _F = 0.3 A	I _F = 0.1 A		
 (mm)	N-ch + SBD	TPCP8AA1	20	±12	1.6	—	—	—	140	105	—	—	306	25	0.7	—	0.41	—	—	—	—	(2)	
		TPCP8A05-H ◇	30	±20	8	1.68	—	—	—	—	21.9	17.5	1300	—	—	—	—	—	—	—	—	16	(1)
 (mm)		TPC8A05-H ◇	30	±20	10	1.9	—	—	—	—	17.6	13.3	—	—	—	—	—	—	—	—	15	(1)	
		TPC8A06-H ◇	30	±20	12	1.9	—	—	—	—	12.9	10.1	1400	—	—	—	—	—	—	—	19	(1)	
		TPC8A03-H ◇	30	±20	17	1.9	—	—	—	—	7	5.6	—	—	—	—	—	—	—	—	36	(1)	
		TPC8A04-H ◇	30	±20	18	1.9	—	—	—	—	4.5	3.6	—	—	—	—	—	—	—	—	56	(1)	
		TPC8A07-H	30	±20	6.8/8.5	1.5	—	—	—	—	28/19	23/15	—	—	—	—	—	—	—	—	6.9/8.1	(3)	
		TPCA8A05-H ◇	30	±20	20	30	—	—	—	—	17.2	12.9	—	—	—	—	—	—	—	—	—	15	(1)
		TPCA8A02-H ◇	30	±20	34	45	—	—	—	—	6.7	5.3	—	—	—	—	—	—	—	—	36	(1)	
		TPCA8A01-H ◇	30	±20	36	45	—	—	—	—	8.5	5.6	—	—	—	—	—	—	—	—	19	(1)	
 (mm)		TPCA8A08-H ◇	30	±20	38	45	—	—	—	—	5.3	4.2	3500	—	—	—	—	—	—	—	48	(1)	
		TPCA8A04-H ◇	30	±20	44	45	—	—	—	—	4.1	3.2	—	—	—	—	—	—	—	—	59	(1)	

◇: Monolithic

- Contact the Toshiba sales representative for information about RoHS compliance before you purchase any components.

◆Internal Connections

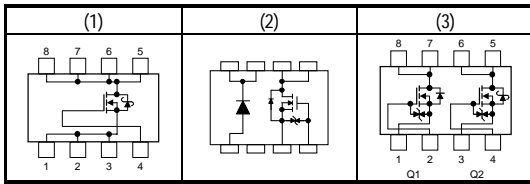

◆The internal connection diagrams only show the general configurations of the circuits.

(MOSFET + Switching Diodes)

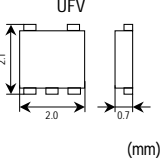
Package	Polarity	Part Number	MOSFET										Di						Qg (nC) (typ.)	Internal Connections	
			V _{DSS} (V)	V _{GSS} (V)	I _D (A)	P _D (W)	R _{DS(ON)} Max (mΩ)						C _{iss} (pF)	V _R (V)	I _o (A)	t _{rr} (ns)	V _F Max (V)				
							V _{GS} = 1.5 V	V _{GS} = 1.8 V	V _{GS} = 2.5 V	V _{GS} = 4.0 V	V _{GS} = 4.5 V	V _{GS} = 10 V					I _F = 1 mA	I _F = 10 mA			I _F = 0.1 A
 (mm)	N-ch + Switching diodes	SSM5H90TU	20	±10	2.4	—	157	110	80	65	—	—	400	80	0.1	1.6	—	—	1.2	—	(1)

• Contact the Toshiba sales representative for information about RoHS compliance before you purchase any components.

(MOSFET + Zener Diodes)

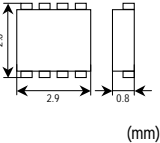
Package	Polarity	Part Number	MOSFET										Ze-Di						Qg (nC) (typ.)	Internal Connections		
			V _{DSS} (V)	V _{GSS} (V)	I _D (A)	P _D (W)	R _{DS(ON)} Max (mΩ)						C _{iss} (pF)	V _Z (V)	I _R (μA)	V _F Max (V)						
							@I _Z (mA)	@V _R (V)	I _F = 1.0 A	I _F = 0.5 A	I _F = 0.3 A											
 (mm)	N-ch + Zener diodes	TPCP8R01	60	±20	2.0	—	—	—	—	440	—	300	140	43	2	0.5	33	—	—	—	—	(2)

• Contact the Toshiba sales representative for information about RoHS compliance before you purchase any components.

◆ Internal Connections

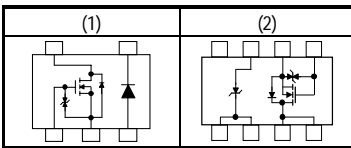

◆ The internal connection diagrams only show the general configurations of the circuits.

Bipolar Power Transistors

Radio-Frequency Switching Power Transistors (2SA/2SC/TTA/TTC Series)

V _{CEO} (V)	I _C (A)	10/(15)	(18)/20	(25)/30	40/(45)	50/(60)
0.2					2SA1483 (45 V) 2SC3803 (45 V) (◎)	
0.8				2SA1426 (S) 2SA1204 (◎) 2SC2884 (◎)	2SA1356 (S) 2SC3419 (◎)	
1	TPC6D02 (15 V) (&)(△)			2SC2703 (♣) 2SC3666 (S) HN4B101J (M)(V) (NPN: 1.2 A)		2SA2070 (◎) TPC6701 (W)(△) 2SC5810 (◎) TPC6901A (M)(△) (PNP: 0.7 A) TPCP8901 (M)(P) (PNP: 0.8 A) TTA007 * TTC007 * (♣) TPC6604 * TPC6504 * (△)
1.2		TPC6D03 (&)(△)		2SA1734 (◎) TPCP8801 (W)(P)		
1.5	2SA2058 (♣)	2SA2065 (♣) 2SA2069 (◎) 2SC5784 (♣) 2SC5819 (◎) TPC6503 (△) S3F56 ++ (△)		2SA966 (♣) 2SC2236 (♣) 2SA1203 (◎) 2SC2883 (◎)		
2	2SA1160 (♣) 2SA1430 (S) 2SA2066 (◎) 2SC5755 (♣) 2SC5785 (◎) TPC6501 (△) TPC6602 (△) TPCP8504 (P)			TPCP8902 (M)(P) (NPN+PNP) TPC6902 (M)(△) (NPN+PNP) : PNP-1.7A HN4B102J (M)(V) (NPN+PNP)	2SC3225 (♣) 2SC3673 (S) 2SC3964 (◎)	2SA1020 (♣) 2SA1241 (◇) 2SA1382 (♣) 2SA2056 (♣) TPC6601 (△) TPCP8701 (W)(P) 2SA2060 (◎) 2SA1428 (S) 2SA1680 (♣) 2SC4008 (♣) 2SA1891 (□) 2SC5692 (♣) 2SC6033 (♣) TPCP8602 (P)
2.5		2SA2061 (♣)				
3	2SC4682 (15 V) (♣) 2SC4683 (15 V) (S)	2SA2059 (◎) TPCP8F01 (S)(P) TPC6603 (△) TPCP8G01 * (S)(P)		2SC5976 (♣) TPCP8H02 (S)(P)	2SA1359 (S) 2SC3422 (◎)	2SA1761 (♣) 2SA1869 (♣) 2SA1892 (□) 2SC4604 (♣) 2SC4935 (♣) 2SC5029 (□) 2SC5712 (◎) TPC6502 (△) TPCP8505 (P) 2SC6126 (◎)
3.5			2SC5738 (♣)			

- The products shown in bold are also manufactured in offshore fabs.
- Contact the Toshiba sales representative for information about RoHS compliance before you purchase any components.

*: New product
++: Being planned

Legend

Package		Surface-Mount Package	Other Remarks
Through-Hole Package	Ammo Packaging		
(♣) LSTM	○ Available	(♣) TSM	(%) Darlington
(S) MSTM	○ Available	(◎) PW-Mini	(#) Built-in zener diode
(□) TPS	◎ Available only in tape packaging	(◇) PW-Mold	Part number in italic signifies built in Freewheel diode.
(@) TO-126	× Not available	(●) TO-220SM	2SA****/2SC****: Complementary
(■) TPL	◎ Available only in tape packaging	(△) VS-6	(&) 2-in-1 (transistor + diode)
(▲) TO-220NIS	× Not available	(P) PS-8	(S) 2-in-1 (transistor + S-MOS)
(◇) PW-Mold	× Not available	(V) SMV	(W) 2-in-1 (NPN (or PNP) × 2)
(▽) TO-3P(N)	× Not available	(♥) TFP	(M) 2-in-1 (NPN + PNP)
(▼) TO-3P(N)IS	× Not available		
(※) TO-3P(L)	× Not available		
(〒) TO-220SIS	× Not available		
(◆) TO-92	◎ Available only in tape packaging		

Radio-Frequency Switching Power Transistors (2SA/2SC/TTA/TTC Series) (Continued)

V _{CEO} (V)	I _C (A)	10/(15)	(18)/20	(25)/30	40/(45)	50/(60)
4		2SC5713 (⊙) S3F61 ++ (Δ)	2SC5714 (⊙) 2SC6125 (⊙) S3F62 ++ (Δ) TPCP8601 (P)	2SC5906 (▲)		2SC5703 (▲)
5			2SA1242 (◇) 2SA1357 (@) 2SA1431 (S) 2SC3072 (◇) 2SC3420 (@) 2SC3671 (S) 2SC4684 (◇) 2SC4685 (@) 2SC5030 (□) 2SC6052 (◇)	2SC6062 (▲)		2SA1244 2SC3074 (◇) 2SA1905 2SC5076 (□) 2SA1931 2SC4881 (▲) 2SA1933 2SC5175 (■) 2SA2097 (◇) 2SC5886 (◇) 2SC5886A (◇) TPCP8H01 (S)(P) S3H32 ++ (◇) 2SA2183 (⎯) (60 V)
7						2SC6000 (◇)
10			2SA1327A (▲)			2SA1887 2SC5000 (▲)
12						2SA1451A 2SC3709A (▲)

• Contact the Toshiba sales representative for information about RoHS compliance before you purchase any components.

++: Being planned

Legend

Package		Surface-Mount Package	Other Remarks
Through-Hole Package	Ammo Packaging		
(♣) LSTM (S) MSTM (□) TPS (@) TO-126 (■) TPL (▲) TO-220NIS (◇) PW-Mold (▽) TO-3P(N) (▼) TO-3P(N)S (※) TO-3P(L) (⎯) TO-220SIS (◆) TO-92	○ Available ○ Available ⊙ Available only in tape packaging × Not available ⊙ Available only in tape packaging × Not available × Not available × Not available × Not available × Not available × Not available ⊙ Available only in tape packaging	(▲) TSM (⊙) PW-Mini (◇) PW-Mold (●) TO-220SM (Δ) VS-6 (P) PS-8 (V) SMV (♥) TFP	(%) Darlington (#) Built-in zener diode Part number in italic signifies built in Freewheel diode. 2SA****/2SC****: Complementary (&) 2-in-1 (transistor + diode) (S) 2-in-1 (transistor + S-MOS) (W) 2-in-1 (NPN (or PNP) × 2) (M) 2-in-1 (NPN + PNP)

V _{CEO} (V)	80		100		120		(140)/150		160	
I _C (A)										
0.05							2SA1145	2SC2705	(♣)	
							2SA1360	2SC3423	(@)	
							2SA949	2SC2229	(♣)	
0.1										2SC2230 (♣)
0.2										2SC3963 (@)
0.4	2SA817A	2SC1627A	(♣)							
	2SA1202	2SC2882	(◎)							
0.8						2SA965	2SC2235	(♣)		
						2SA1425	2SC3665	(\$)		
1						TPCP8603	TPCP8507	(P)		
							TPCP8510 *	(P)		
							2SC6061	(♣)		
						2SA1358	2SC3421	(@)		2SA1013 2SC2383 (♣)
1.5										
							2SA1408	2SC2073A	(▲)	2SA1225 2SC2983 (◇)
								2SC3621	(@)	2SC5154 (□)
										2SA2219 * 2SC6139 * (\$)
										2SA2220 * 2SC6140 * (■)
										TTA004 * TTC004 * (@)
2	2SA1315	2SC3328	(♣)							
	2SA1429	2SC3669	(\$)		TPCP8501 (P)					
		2SC3474	(◇)							
		2SC6079	(\$)							
	2SA2206	2SC6124	(◎)							
2.5		2SC6075	(□)							
		2SC6087	(□)							
3	2SA1926		(\$)							
	TTA003		(◇)							
		2SC6076	(◇)							
		2SC6077	(■)							
		2SC6078	(■)							
		TTC009 ++	(▲)							
5	2SA1934	2SC5176	(■)							
		2SC3303	(◇)							
6		2SC4688	(▼)							
	2SA1939	2SC5196	(▽)							
8							2SC4689	(▼)		
						2SA1940	2SC5197	(▽)		
10										
								2SC4690	(▼)	
								(140 V)		
							2SA1941	2SC5198	(▽)	
								(140 V)		
12	2SA1452A	2SC3710A	(▲)							2SA1942 2SC5199 (※)
	2SA1771		(▲)							
18										TTA0001 * TTC0001 * (▽)
										TTA0002 * TTC0002 * (※)

• The products shown in bold are also manufactured in offshore fabs.

• Contact the Toshiba sales representative for information about RoHS compliance before you purchase any components.

*: New product
++: Being planned

Legend

Package			Other Remarks
Through-Hole Package	Ammo Packaging	Surface-Mount Package	
(♣) LSTM	○ Available	(♣) TSM	(%) Darlington
(\$) MSTM	○ Available	(◎) PW-Mini	(#) Built-in zener diode
(□) TPS	◎ Available only in tape packaging	(◇) PW-Mold	Part number in italic signifies built in Freewheel diode.
(@) TO-126	× Not available	(●) TO-220SM	2SA****/2SC****: Complementary
(■) TPL	◎ Available only in tape packaging	(△) VS-6	(&) 2-in-1 (transistor + diode)
(▲) TO-220NIS	× Not available	(P) PS-8	(\$) 2-in-1 (transistor + S-MOS)
(◇) PW-Mold	× Not available	(V) SMV	(W) 2-in-1 (NPN (or PNP) × 2)
(▽) TO-3P(N)	× Not available	(♥) TFP	(M) 2-in-1 (NPN + PNP)
(▼) TO-3P(N)IS	× Not available		
(※) TO-3P(L)	× Not available		
(▮) TO-220SIS	× Not available		
(◆) TO-92	◎ Available only in tape packaging		

Radio-Frequency Switching Power Transistors (2SA/2SC/TTA/TTC Series) (Continued)

V _{CEO} (V)	(180)/200	230	300	(370)/400	450
0.05				2SC5122 (♣) 2SC5307 (◎)	
0.1	2SC2230A (♣) (180 V)		2SA1432 2SC3672 (\$) 2SC3619 (@) 2SC3620 (@) 2SC4544 (▲) 2SC5027 (□) 2SA1384 2SC3515 (◎)		
0.3				TPCP8604 (P)	
0.5				2SA1923 (◇) 2SA1924 (@) 2SA1925 (□) 2SA1971 (◎) 2SA1972 (♣)	
0.8			2SC6136 (◆) (285V/0.7A)	2SC3075 (◇) 2SC3425 (@) 2SC5208 (□) 2SC5458 (◇)	
1		2SA1837 2SC4793 (▲) 2SA1932 2SC5174 (■) 2SA2182 2SC6060 (〒)	2SC5930 (\$) (285 V) 2SC6010 (\$) (285 V) 2SC6034 (\$) (285 V) TTC005 * (◎)	2SC5549 (♣) 2SC5550 (@) 2SC6042 (\$) (375 V) 2SC6040 (\$) (410 V) TPCP8508 ++ (P) (375 V)	
1.5				2SC6142 * (◇) (375 V 1.5 A) TTC003 (◇) TTC13003L * (♣)	
2	2SA1930 2SC5171 (▲) (180 V) (180 V) 2SA2190 2SC6072 (〒) (180 V) (180 V)			2SC5075 (□) 2SC5548 (◇) (370 V) 2SC5548A (◇) 2SA2034 (◇)	2SC5351 (□) 2SC5368 (@)
3				2SC5459 (▲)	
5				2SC5172 (▲) 2SC5266A (■) 2SC5355 (‡) 2SC6138 ++ (◇) (375 V)	
8					2SC5439 (▲)
10				2SC5352 (▽)	
12	2SA2120 2SC5948 (▽)				
15	2SA2121 2SC5949 (※)	2SA1943 2SC5200 (※) 2SA1962 2SC5242 (▽) 2SA1986 2SC5358 (▽) 2SA1987 2SC5359 (※) TTA1943 * TTC5200 * (※)			

- The products shown in bold are also manufactured in offshore fabs.
- Contact the Toshiba sales representative for information about RoHS compliance before you purchase any components.

*: New product
 ++: Being planned

Legend

Package		Surface-Mount Package	Other Remarks
Through-Hole Package	Ammo Packaging		
(♣) LSTM	○ Available	(♣) TSM	(%) Darlington
(§) MSTM	○ Available	(◎) PW-Mini	(#) Built-in zener diode
(□) TPS	◎ Available only in tape packaging	(◇) PW-Mold	Part number in italic signifies built in Freewheel diode.
(@) TO-126	× Not available	(●) TO-220SM	2SA****/2SC****: Complementary
(■) TPL	◎ Available only in tape packaging	(Δ) VS-6	(&) 2-in-1 (transistor + diode)
(▲) TO-220NIS	× Not available	(P) PS-8	(§) 2-in-1 (transistor + S-MOS)
(◇) PW-Mold	× Not available	(V) SMV	(W) 2-in-1 (NPN (or PNP) × 2)
(▽) TO-3P(N)	× Not available	(♥) TFP	(M) 2-in-1 (NPN + PNP)
(▼) TO-3P(N)IS	× Not available		
(※) TO-3P(L)	× Not available		
(〒) TO-220SIS	× Not available		
(◆) TO-92	◎ Available only in tape packaging		

V _{CEO} (V) I _C (A)	(550)/600	800	1000/(1200)	1500
0.02				
0.05	2SC5201 (♣)	2SC5460 (@) 2SC5466 (▲) 2SC6127 (◇)	2SC4686 (▲) 2SC4686A (▲) (1200 V)	
0.5	2SA1937 (◇) 2SA2142 (◇)			
0.8		2SC3405 (◇) 2SC5465 (◇) 2SC5562 (□) 2SC5684 (■)		
1	2SA2184 (◇) (550 V)			
3		2SC5353 (▲)		
5		2SC5354 (▽)		
10		2SC3307 (※)		

- The products shown in bold are also manufactured in offshore fabs.
- Contact the Toshiba sales representative for information about RoHS compliance before you purchase any components.

Legend

Package		Surface-Mount Package	Other Remarks
Through-Hole Package	Ammo Packaging		
(♣) LSTM	○ Available	(♠) TSM	(%) Darlington
(§) MSTM	○ Available	(⊙) PW-Mini	(#) Built-in zener diode
(□) TPS	⊙ Available only in tape packaging	(◇) PW-Mold	Part number in italic signifies built in Freewheel diode.
(@) TO-126	× Not available	(●) TO-220SM	2SA****/2SC****: Complementary
(■) TPL	⊙ Available only in tape packaging	(Δ) VS-6	(&) 2-in-1 (transistor + diode)
(▲) TO-220NIS	× Not available	(P) PS-8	(\$) 2-in-1 (transistor + S-MOS)
(◇) PW-Mold	× Not available	(V) SMV	(W) 2-in-1 (NPN (or PNP) × 2)
(▽) TO-3P(N)	× Not available	(♥) TFP	(M) 2-in-1 (NPN + PNP)
(▼) TO-3P(N)IS	× Not available		
(※) TO-3P(L)	× Not available		
(〒) TO-220SIS	× Not available		
(◆) TO-92	⊙ Available only in tape packaging		

Low-Frequency Power Transistors (2SB/2SD/TTB/TTD Series)

V _{CEO} (V)	I _C (A)	20	30	40	50	60/(65)
0.8						2SD2719 (#)(%)(▲)
1						2SD2686 (#)(%)(◎)
1.5			2SD1140 (%)(♣) 2SD1224 (%)(◇) 2SD1508 (%)(@) 2SD1631 (%)(\$) 2SD1784 (%)(◎) 2SD2481 (%)(□)			
2		<i>2SD1160</i> (◇)				<i>2SD1658</i> (#)(%)(@) <i>2SD2088</i> (#)(%)(♣) <i>2SD2695</i> (#)(%)(♣) 2SD2352 (▲)
3				<i>2SB907</i> <i>2SD1222</i> (%)(◇)		2SD2461 (□) 2SD1221 (◇) <i>2SB1375</i> <i>2SD2012</i> (▲) 2SD2462 (□) 2SB1640 2SD2525 (■) 2SD2353 (▲) TTB001 * (♥) TTB002 * (◇) 2SB1667 (●)
4						<i>2SD2130</i> (#)(%)(@) <i>2SD2204</i> (#)(%)(▲) (65 V)
5						<i>2SD2131</i> (#)(%)(▲)
7					2SD1412A (▲)	

• The products shown in bold are also manufactured in offshore fabs.

• Contact the Toshiba sales representative for information about RoHS compliance before you purchase any components.

*: New product

Legend

Package		Surface-Mount Package	Other Remarks
Through-Hole Package	Ammo Packaging		
(♣) LSTM	○ Available	(▲) TSM	(%) Darlington
(\$) MSTM	○ Available	(◎) PW-Mini	(#) Built-in zener diode
(□) TPS	◎ Available only in tape packaging	(◇) PW-Mold	Part number in italic signifies built in Freewheel diode.
(@) TO-126	× Not available	(●) TO-220SM	2SA****/2SC****: Complementary
(■) TPL	◎ Available only in tape packaging	(Δ) VS-6	(&) 2-in-1 (transistor + diode)
(▲) TO-220NIS	× Not available	(P) PS-8	(\$) 2-in-1 (transistor + S-MOS)
(◇) PW-Mold	× Not available	(V) SMV	(W) 2-in-1 (NPN (or PNP) × 2)
(▽) TO-3P(N)	× Not available	(♥) TFP	(M) 2-in-1 (NPN + PNP)
(▼) TO-3P(N)IS	× Not available		
(※) TO-3P(L)	× Not available		
(〒) TO-220SIS	× Not available		
(◆) TO-92	◎ Available only in tape packaging		

V _{CEO} (V)	80		100		120		150/(160)		200	
I _C (A)										
0.9					TPCP8L01(t) (&)(P)					
1.5							2SB905 2SD1220 (◇)			
2	<i>2SB1067</i>	<i>2SD1509</i> (%)(@)	2SB1457	2SD2206 (%) (♣)						
			<i>2SB1617</i>	<i>2SD2480</i> (%) (□)						
				<i>2SD2536</i> (#) (%) (♣)						
3			<i>2SB1495</i>	<i>2SD2257</i> (%) (▲)						
				<i>2SD2092</i> (▲)						
				<i>2SD2129</i> (%) (▲)						
4	<i>2SB908</i>	<i>2SD1223</i> (%) (◇)	<i>2SB1481</i>	<i>2SD2241</i> (%) (▲)						
		<i>2SD2406</i> (▲)								
5				<i>2SD2079</i> (%) (▲)						
				<i>2SD2526</i> (%) (■)						
			<i>2SB1016A</i>	<i>2SD1407A</i> (▲)						
				2SD2604 (#) (%) (▲)						
7	<i>2SB1018</i> A	<i>2SD1411A</i> (▲)	<i>2SB1020</i> A	<i>2SD1415A</i> (%) (▲)						
8								<i>2SD2636</i> (%) (▽)		
								(160 V)		
10				<i>2SD1947A</i> (▲)						
12										
15				<i>2SD1662</i> (%) (▽)						
30				<i>2SD1525</i> (%) (※)						

(1) NPN + HED (200 V/1 A)

- The products shown in bold are also manufactured in offshore fabs.
- Contact the Toshiba sales representative for information about RoHS compliance before you purchase any components.

V _{CEO} (V)	250		400		450	
I _C (A)						
6	<i>2SD1410A</i> (%) (▲)		<i>2SD1409A</i> (%) (▲)			
15					<i>2SD1314</i> (%) (※)	

- Contact the Toshiba sales representative for information about RoHS compliance before you purchase any components.

Legend

Package		Surface-Mount Package	Other Remarks
Through-Hole Package	Ammo Packaging		
(♣) LSTM	○ Available	(▲) TSM	(%) Darlington
(\$) MSTM	○ Available	(◎) PW-Mini	(#) Built-in zener diode
(□) TPS	◎ Available only in tape packaging	(◇) PW-Mold	Part number in italic signifies built in Freewheel diode.
(@) TO-126	× Not available	(●) TO-220SM	2SA****/2SC****: Complementary
(■) TPL	◎ Available only in tape packaging	(△) VS-6	(&) 2-in-1 (transistor + diode)
(▲) TO-220NIS	× Not available	(P) PS-8	(\$) 2-in-1 (transistor + S-MOS)
(◇) PW-Mold	× Not available	(V) SMV	(W) 2-in-1 (NPN (or PNP) × 2)
(▽) TO-3P(N)	× Not available	(♥) TFP	(M) 2-in-1 (NPN + PNP)
(▼) TO-3P(N)IS	× Not available		
(※) TO-3P(L)	× Not available		
(⎓) TO-220SIS	× Not available		
(◆) TO-92	◎ Available only in tape packaging		

Transistors for Power Amps (Drive Stage)

Part Number		Ic (A)	V _{CEO} (V)	Pc (W) T _c = 25°C (♣ Ta = 25°C)	f _r (MHz) Typ. (NPN/PNP)			Package
NPN	PNP					V _{CE} (V)	Ic (A)	
2SC1627A	2SA817A	0.4	80	♣ 0.8	100	10	0.01	LSTM
2SC2235	2SA965	0.8	120	♣ 0.9	120	5	0.1	
2SC3665	2SA1425	0.8	120	♣ 1	120	5	0.1	MSTM
2SC6139 *	2SA2219 *	1.5	160	♣ 1	100	10	0.1	
2SC5174	2SA1932	1	230	♣ 1.8	100/70	10	0.1	TPL
2SC6140 *	2SA2220 *	1.5	160	♣ 1.8	100	10	0.1	
2SC3423	2SA1360	0.05	150	5	200	5	0.01	TO-126
2SC3421	2SA1358	1	120	10	120	5	0.1	
TTC004 *	TTA004 *	1.5	160	10	100	10	0.1	TO-126
2SC2983	2SA1225	1.5	160	15	100	10	0.1	PW-Mold
2SC4793	2SA1837	1	230	20	100/70	10	0.1	TO-220NIS
2SC6060	2SA2182	1	230	20	100/80	10	0.1	TO-220SIS
2SC5171	2SA1930	2	180	20	200	5/10	0.3	TO-220NIS
2SC6072	2SA2190	2	180	20	200	5	0.3	TO-220SIS

• Contact the Toshiba sales representative for information about RoHS compliance before you purchase any components.

*: New product

(Output Stage)

Part Number		Ic (A)	V _{CEO} (V)	Pc (W) T _c = 25°C (♣ Ta = 25°C)	f _r (MHz) Typ. (NPN/PNP)			Package
NPN	PNP					V _{CE} (V)	Ic (A)	
2SC5196	2SA1939	6	80	60	30	5	1	TO-3P(N)
2SC5197	2SA1940	8	120	80	30	5	1	
2SC5198	2SA1941	10	140	100	30	5	1	
TTC0001 *	TTA0001 *	18	160	150	30	10	1	
2SC5242	2SA1962	15	230	130	30	5	1	
2SC5358	2SA1986	15	230	150	30	5	1	
2SC5948	2SA2120	12	200	200	30/25	5	1	
2SC5199	2SA1942	12	160	120	30	5	1	TO-3P(L)
TTC0002 *	TTA0002 *	18	160	180	30	10	1	
2SC5200	2SA1943	15	230	150	30	5	1	
TTC5200 *	TTA1943 *	15	230	150	30	5	1	
2SC5359	2SA1987	15	230	180	30	5	1	
2SC5949	2SA2121	15	200	220	30/25	5	1	

• Contact the Toshiba sales representative for information about RoHS compliance before you purchase any components.

*: New product

Transistors for MOS Gate Drivers/Compact Motor Drivers (2-in-1 Transistors)

Part Number	Polarity	Absolute Maximum Ratings				hFE		VCE		VCE(sat)			Package	Circuit Configuration (Top View)
		VCE0 (V)	IC (A)	ICP (A)	PC (Note 1) (mW)	Min	Max	(V)	(A)	(V)	IC (A)	IB (mA)		
HN4B101J	PNP	-30	-1.0	-5	550	200	500	-2	-0.12	-0.2	-0.4	-13	SMV	
	NPN	30	1.2	5	550	200	500	2	0.12	0.17	0.4	13		
HN4B102J	PNP	-30	-1.8	-8	750	200	500	-2	-0.2	-0.2	-0.6	-20		
	NPN	30	2	8	750	200	500	2	0.2	0.14	0.6	20		
TPC6901A	PNP	-50	-0.7	-5	400	200	500	-2	-0.1	-0.23	-0.3	-10	VS-6	
	NPN	50	1	5	400	400	1000	2	0.1	0.17	0.3	6		
TPC6902	PNP	-30	-1.7	-8	700	200	500	-2	-0.2	-0.2	-0.6	-20		
	NPN	30	2	8	700	200	500	2	0.2	0.14	0.6	20		
TPCP8901	PNP	-50	-0.8	-5	830	200	500	-2	-0.1	-0.2	-0.3	-10	PS-8	
	NPN	50	1	5	830	400	1000	2	0.1	0.17	0.3	6		
TPCP8902	PNP	-30	-2	-8	890	200	500	-2	-0.2	-0.2	-0.6	-20		
	NPN	30	2	8	890	200	500	2	0.2	0.14	0.6	20		

Note 1: The rating applies when the transistor is mounted on an FR4 board (Cu area = 645 mm², glass-epoxy, t = 1.6 mm) and is in single-device operation.

Copper thickness: 35 mm for the TPC6901A and 70 mm for the other transistors

- Contact the Toshiba sales representative for information about RoHS compliance before you purchase any components.

(1-in-1 Transistors)

Part Number	Polarity	Absolute Maximum Ratings			hFE		VCE		VCE(sat)			Complementary	Package	Remarks
		VCE0 (V)	IC (A)	PC (Note 1) (mW)	Min	Max	(V)	(A)	(V)	IC (A)	IB (mA)			
2SA2058	PNP	-10	-1.5	500	200	500	-2	-0.2	-0.19	-0.6	-20	2SC5755		(Note 2)
2SA2065		-20	-1.5	500	200	500	-2	-0.15	-0.14	-0.5	-17	2SC5784		
2SA2061		-20	-2.5	625	200	500	-2	-0.5	-0.19	-1.6	-53	2SC5735		
TTA007 *		-50	-1	700	200	500	-2	-0.1	-0.2	-0.3	-10	TTC007 *		
2SA2056		-50	-2	625	200	500	-2	-0.3	-0.20	-1.0	-33	2SC5692		
2SC5755		10	2	500	400	1000	2	0.2	0.12	0.6	12	2SA2058		
2SC5784	20	1.5	500	400	1000	2	0.15	0.12	0.5	10	2SA2065			
2SC5738	20	3.5	625	400	1000	2	0.5	0.15	1.6	32	2SA2061			
2SC6062	30	5	800	250	400	2	0.5	0.12	1.6	53	—			
TTC007 *	50	1	700	400	1000	2	0.1	0.12	0.3	6	TTA007 *			
2SC5692	50	2.5	625	400	1000	2	0.3	0.14	1.0	20	2SA2056			
2SA2066	PNP	-10	-2	1000	200	500	-2	-0.2	-0.19	-0.6	-20	2SC5785		
2SA2069		-20	-1.5	1000	200	500	-2	-0.15	-0.14	-0.5	-17	2SC5819		
2SA2059		-20	-3	1000	200	500	-2	-0.5	-0.19	-1.6	-53	2SC5714		
2SA2070		-50	-1	1000	200	500	-2	-0.1	-0.20	-0.3	-10	2SC5810		
2SA2060		-50	-2	1000	200	500	-2	-0.3	-0.20	-1.0	-33	2SC5712		
2SC5785		10	2	1000	400	1000	2	0.2	0.12	0.6	12	2SA2066		
2SC5819	20	1.5	1000	400	1000	2	0.15	0.12	0.5	10	2SC2069			
2SC5714	20	4	1000	400	1000	2	0.5	0.15	1.6	32	2SA2059			
2SC5810	50	1	1000	400	1000	2	0.1	0.17	0.3	6	2SA2070			
2SC5712	50	3	1000	400	1000	2	0.3	0.14	1	20	2SA2060			
2SC6126	50	3	1000	250	400	2	0.3	0.18	1	33	—			

Note 1: The rating applies when the transistor is mounted on an FR4 board (Cu area = 645 mm², t = 1.6 mm).

*: New product

Note 2: Ultra-high-speed using by the Super Hi-Met process and Low VCE(sat) products.

- Contact the Toshiba sales representative for information about RoHS compliance before you purchase any components.

Transistors for Switching Power Supplies (For AC/DC Converters)

Part Number	Applications	Absolute Maximum Ratings (Ta = 25°C)				Package
		V _{CB0} (V)	V _{CEO} (V)	I _c (A)	P _c (W) T _c = 25°C (♣ Ta = 25°C)	
2SC3425	Switching regulator	500	400	0.8	10	TO-126
2SC5075				2	1.3♣	TPS
2SC5930		285	1	1♣	MSTM	
2SC6010			1	1♣	MSTM	
2SC6034			1	1♣	MSTM	
2SC5548			370	2	15	PW-Mold
2SC5548A			600	2	15	PW-Mold
2SC5208		0.8		1.3♣	TPS	
2SC5458		0.8		10	PW-Mold	
2SC4917		2		10	TO-126	
TTC003 *		1.5		1.1♣	PW-Mold	
2SC5459		3		25	TO-220NIS	
2SC5266A		5		1.8♣	TPL	
2SC5172		5		25	TO-220NIS	
2SC5352		10		80	TO-3P(N)	
2SC5351		650		450	2	1.3♣
2SC5368			2		10	TO-126
2SC6042		800	375	1	1♣	MSTM
2SC6040			410	1	1♣	MSTM
2SC6142 *			375	1.5	1.1♣	PW-Mold
2SC5562		900	800	0.8	1.3♣	TPS
2SC5353				3	25	TO-220NIS
2SC5354				5	100	TO-3P(N)
2SC3307				10	150	TO-3P(L)
2SC5439				1000	450	8

• Contact the Toshiba sales representative for information about RoHS compliance before you purchase any components.

*: New product

Transistors for High-Voltage Power Supplies (For DC/DC Converters)

Part Number	Absolute Maximum Ratings				hFE				VCE (sat) (V)			Package
	VCEX (V)	VCEO (V)	Ic (A)	Pc (W)			VCE (V)	Ic (A)	Max	Ic (A)	Ib (mA)	
					Min	Max						
2SC6061	150	120	1	0.625 (Note 1)	120	300	2	0.1	0.14	0.3	10	TSM
TPCP8510 *	150	120	1	1.1 (Note 1)	120	300	2	0.1	0.14	0.3	10	PS-8
TPCP8507	150	120	1	1.25 (Note 1)	120	300	2	0.1	0.14	0.3	10	PS-8
2SC6076	160	80	3	10 (Note 2)	180	450	2	0.5	0.5	1	100	PW-Mold
2SC6124	160	80	2	1 (Note 1)	100	200	2	0.5	0.5	1	100	PW-Mini
2SC6079	160	80	2	1 (Note 3)	180	450	2	0.5	0.5	1	100	MSTM
2SC6075	160	80	2.5	1.3 (Note 3)	180	450	2	0.5	0.5	1	100	TPS
2SC6087	160	80	2.5	1.3 (Note 3)	100	200	2	0.5	0.5	1	100	TPS
2SC6077	160	80	3	1.8 (Note 3)	180	450	2	0.5	0.5	1	100	TPL
2SC6078	160	80	3	1.8 (Note 3)	100	200	2	0.5	0.5	1	100	TPL

Note 1: The rating applies when the transistor is mounted on an FR4 board (Cu area = 645 mm², glass-epoxy, t = 1.6 mm).

*: New product

Note 2: Tc = 25°C

Note 3: Ta = 25°C

- Contact the Toshiba sales representative for information about RoHS compliance before you purchase any components.

(Transistors for Droppers)

Part Number	Absolute Maximum Ratings			hFE				VCE (sat) (V)			Package
	VCEO (V)	Ic (A)	Pc (W) Tc = 25°C			VCE (V)	Ic (A)	Max	Ic (A)	Ib (mA)	
				Min	Max						
2SB906	-60	-3	20	60	200	-5	-0.5	-1.7	-3	-300	PW-Mold
2SB1667	-60	-3	25	60	300	-5	-0.5	-1.7	-3	-300	TO-220SM
2SA2183	-60	-5	20	200	500	-2	-0.5	-1	-1.6	-53	TO-220SIS
TTB001 *	-60	-3	36	100	250	-5	-0.5	-1.7	-3	-300	TFP
TTB002 *	-60	-3	25	100	250	-5	-0.5	-1.7	-3	-300	PW-Mold

- Contact the Toshiba sales representative for information about RoHS compliance before you purchase any components.

*: New product

(High-Voltage Transistors)

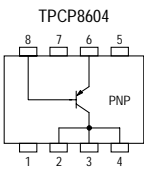
Part Number	Absolute Maximum Ratings			Package	Circuit Configuration (Top View)	Remarks
	VCEO (V)	Ic (A)	Pc (W)			
2SA1972	-400	-0.5	0.9	LSTM		
2SA1971	-400	-0.5	1	PW-Mini		
TPCP8604	-400	-0.3	1	PS-8		SMD
2SA1925	-400	-0.5	1.2	TPS		
2SA2184	-550	-1	1	PW-Mold		SMD only
2SA2142	-600	-0.5	10	PW-Mold		SMD only
2SC5122	400	0.05	0.9	LSTM		
2SC5307	400	0.05	1	PW-Mini		
2SC5201	600	0.05	0.9	LSTM		
2SC6127	800	0.05	10	PW-Mold		SMD only
2SC5460	800	0.05	10	TO-126		
2SC5466	800	0.05	10	TO-220NIS		
2SC4686A	1200	0.05	10	TO-220NIS		
2SC5563	1500	0.02	10	TO-220NIS		

- The circuit configuration diagrams only show the general configurations of the circuits.

- Contact the Toshiba sales representative for information about RoHS compliance before you purchase any components.

Low Saturation Voltage Transistors (Small Surface-Mount Packages for Personal Equipments)

Part Number	Configuration	Absolute Maximum Ratings					hFE				VCE (sat) (V)			Marking	Package	
		VCE0 (V)	Ic (A)	ICP (A)	Pc (mW) (Note 1)	Pc (mW) (Note 1) t = 10 s			VCE (V)	Ic (A)	Max	Ic (A)	Ib (mA)			
							Min	Max								
2SA2058	PNP single	-10	-1.5	-2.5	500	750	200	500	-2	-0.2	-0.19	-0.6	-20	WM	TSM (equivalent to SC-59 SOT-23)	
2SA2065		-20	-1.5	-2.5	500	750	200	500	-2	-0.15	-0.14	-0.5	-17	WK		
2SA2061		-20	-2.5	-4	625	1000	200	500	-2	-0.5	-0.19	-1.6	-53	WE		
TTA007 *		-50	-1	-2	700	1100	200	500	-2	-0.1	-0.2	-0.3	-10	WH		
2SA2056		-50	-2	-3.5	625	1000	200	500	-2	-0.3	-0.20	-1.0	-33	WF		
2SC5755	NPN single	10	2	3.5	500	750	400	1000	2	0.2	0.12	0.6	12	WL		
2SC5784		20	1.5	2.5	500	750	400	1000	2	0.15	0.12	0.5	10	WJ		
2SC5738		20	3.5	6	625	1000	400	1000	2	0.5	0.15	1.6	32	WD		
2SC5976		30	3	5	625	1000	250	400	2	0.3	0.14	1.0	33	WW		
2SC5906		30	4	7	800	1250	200	500	2	0.5	0.2	1.6	53	WP		
2SC6062		30	5	10	800	1250	250	400	2	0.5	0.12	1.6	53	WR		
TTC007 *		50	1	2	700	1100	400	1000	2	0.1	0.12	0.3	6	WG		
2SC5692		50	2.5	4	625	1000	400	1000	2	0.3	0.14	1.0	20	WB		
2SC6033		50	2.5	5	625	1000	250	400	2	0.3	0.18	1.0	33	WX		
2SC5703		50	4	7	800	1250	400	1000	2	0.5	0.12	1.6	32	WA		
2SC6061		120	1	2	625	1000	120	300	2	0.1	0.14	0.3	10	WN		
HN4B101J		PNP + NPN	±30	-1/1.2	±5	550	850	200	500	±2	±0.12	-0.2/0.17	±0.4	±13	5K	SMV
HN4B102J			±30	-1.8/2	±8	750	750	200	500	±2	±0.2	-0.2/0.14	±0.6	±20	5L	
2SA2066	PNP single	-10	-2	-3.5	1000	2000	200	500	-2	-0.2	-0.19	-0.6	-20	4E	PW-Mini (equivalent to SC-62 SOP-89)	
2SA2069		-20	-1.5	-2.5	1000	2000	200	500	-2	-0.15	-0.14	-0.5	-17	4D		
2SA2059		-20	-3	-5	1000	2500	200	500	-2	-0.5	-0.19	-1.6	-53	4F		
2SA2070		-50	-1	-2	1000	2000	200	500	-2	-0.1	-0.2	-0.3	-10	4C		
2SA2060		-50	-2	-3.5	1000	2500	200	500	-2	-0.3	-0.20	-1.0	-33	4G		
2SA2206		-80	-2	-4	1000	2500	100	200	-2	-0.5	-0.5	-1.0	-100	4K		
2SC5785	NPN single	10	2	3.5	1000	2000	400	1000	2	0.2	0.12	0.6	12	3E		
2SC5713		10	4	7	1000	2500	400	1000	2	0.5	0.15	1.6	32	2C		
2SC5819		20	1.5	2.5	1000	2000	400	1000	2	0.15	0.12	0.5	10	3D		
2SC6125		20	4	8	1000	2500	180	390	2	0.5	0.2	1.6	53	4L		
2SC5714		20	4	7	1000	2500	400	1000	2	0.5	0.15	1.6	32	2E		
2SC5810		50	1	2	1000	2000	400	1000	2	0.1	0.17	0.3	6	3C		
2SC6126		50	3	6	1000	2500	250	400	2	0.3	0.18	1.0	33	4M		
2SC5712		50	3	5	1000	2500	400	1000	2	0.3	0.14	1	20	2A		
2SC6124		80	2	4	1000	2500	100	200	2	0.5	0.5	1.0	100	4J		
TPC6501	NPN single	10	2	3.5	800	1600	400	1000	2	0.2	0.12	0.6	12	H2A	VS-6 (equivalent to TSOP-6)	
TPC6502		50	3	5	800	1600	400	1000	2	0.3	0.14	1	20	H2B		
TPC6503		20	1.5	2.5	800	1600	400	1000	2	0.15	0.12	0.5	10	H2C		
S3F61 ++		10	4	6	800	1600	400	1000	2	0.5	0.15	1.6	32	—		
S3F62 ++		20	4	6	800	1600	400	1000	2	0.5	0.15	1.6	32	—		
TPC6504 *		50	1	2	800	1600	400	1000	2	0.1	0.17	0.3	6	H2D		
TPC6601	PNP single	-50	-2	-3.5	800	1600	200	500	-2	-0.3	-0.20	-1.0	-33	H3A		
TPC6602		-10	-2	-3.5	800	1600	200	500	-2	-0.2	-0.19	-0.6	-20	H3B		
TPC6603		-20	-3	-5	800	1600	200	500	-2	-0.5	-0.19	-1.6	-53	H3C		
S3F56 ++		-20	-1.5	-2.5	800	1600	200	500	-2	-0.15	-0.14	-0.5	-17	—		
TPC6604 *		-50	-1	-2	800	1600	200	500	-2	-0.1	-0.23	-0.3	-10	H3D		
TPC6701	NPN/dual	50	1	2	660 (注 2)	—	400	1000	2	0.1	0.17	0.3	6	H4A		
TPC6901A	PNP + NPN	±50	-0.7/1.0	±5	400	500	200/400	500/1000	±2	±0.1	-0.23/0.17	±0.3	-10/6	H6B		
TPC6902		±30	-1.7/2	±8	700	1000	200	500	±2	±0.2	-0.2/0.14	±0.6	±20	H6C		

Note 1: The rating applies when the transistor is mounted on an FR4 board (Cu area = 645 mm², glass-epoxy, t = 1.6 mm).

*: New product

Note 2: Total loss of dual-device operation

++: Being planned

- Contact the Toshiba sales representative for information about RoHS compliance before you purchase any components.

Part Number	Configuration	Absolute Maximum Ratings					hFE				VCE (sat) (V)			Marking	Package
		VCE0 (V)	IC (A)	ICP (A)	Pc (mW) (Note 1)	Pc (mW) (Note 1) t = 10 s			VCE (V)	IC (A)	Max	IC (A)	IB (mA)		
							Min	Max							
2SA2097	PNP single	-50	-5	-10	20 (Note 3)	—	200	500	-2	-0.5	-0.27	-1.6	-53	A2097	PW-Mold SC-63
2SA1241		-50	-2	-3	10 (Note 3)	—	70	240	-2	-0.5	-0.5	-1	-50	A1241	
2SA1244		-50	-5	-8	20 (Note 3)	—	70	240	-1	-1	-0.4	-3	-150	A1244	
TTA003 *	NPN single	-80	-3	-5	10 (Note 3)	—	100	200	-2	-0.5	-0.5	-1	-100	A003	
2SC6076		80	3	5	10 (Note 3)	—	180	450	2	0.5	0.5	1	100	C6076	
2SC5886		50	5	10	20 (Note 3)	—	400	1000	2	0.5	0.22	1.6	32	C5886	
2SC5886A		50	5	10	20 (Note 3)	—	400	1000	2	0.5	0.22	1.6	32	C5886A	
2SC3076		50	2	3	10 (Note 3)	—	70	240	2	0.5	0.5	1	50	C3076	
2SC3474		80	2	3	20 (Note 3)	—	500	—	1	0.4	0.5	0.3	1	C3474	
2SC6052		20	5	7	10 (Note 3)	—	180	390	2	0.5	0.2	1.6	53	C6052	
2SC3074		50	5	8	20 (Note 3)	—	70	240	1	1	0.4	3	150	C3074	
S3H32 ++		50	5	7	20 (Note 3)	—	200	500	2	0.5	0.2	1.6	53		
2SC3303		80	5	8	20 (Note 3)	—	70	240	1	1	0.4	3	150	C3303	
2SC6000	50	7	10	20 (Note 3)	—	250	400	2	2.5	0.18	2.5	83	C6000		
TPCP8501	NPN single	100	2	4	1300	3300	100	300	2	0.3	0.2	1	33	8501	PS-8
TPCP8507		120	1	2	1250	3000	120	300	2	0.1	0.14	0.3	10	8507	
TPCP8510 *		120	1	2	1100	2250	120	300	2	0.1	0.14	0.3	10	8510	
TPCP8505		50	3	5	1250	3000	400	1000	2	0.3	0.14	1	20	8505	
TPCP8504		10	2	3.5	1200	2800	400	1000	2	0.2	0.12	0.6	12	8504	
TPCP8601	PNP single	-20	-4	-7	1300	3300	200	500	-2	-0.6	-0.19	-2	-67	8601	
TPCP8603		-120	-1	-2	1250	3000	120	300	-2	-0.1	-0.2	-0.3	-10	8603	
TPCP8602		-50	-2.5	-4	1250	3000	200	500	-2	-0.3	-0.2	-1	-33	8602	
TPCP8701	NPN/dual	50	3	5	940	1770	400	1000	2	0.3	0.14	1	20	8701	
TPCP8H01 (Note 2)	NPN +	50	5	7	1000	2000	250	400	2	0.5	0.13	1.6	53	8H01	
TPCP8H02 (Note 2)	S-MOS	30	3	5	1000	2000	250	400	2	0.3	0.14	1	33	8H02	
TPCP8F01 (Note 2)	PNP + S-MOS	-20	-3	-5	1000	—	200	500	-2	-0.5	-0.19	-1.6	-53	8F01	
TPCP8901	PNP + NPN	±50	-0.8/1.0	±5	830	1480	200/400	500/1000	±2	±0.1	-0.2/0.17	±0.3	-10/6	8901	
TPCP8902 *		±30	±2	±8	890	1670	200	500	±2	±0.2	-0.2/0.14	±0.6	±20	8902	
TPCP8L01 (Note 4)	NPN Darlington + HED	120	0.9	2	900	—	2000	9000	2	1	1.5	1	1	8L01	
TPCP8G01 (Note 5) *	PNP + Pch	-20	-3	-5	940	1770	200	500	-2	-0.5	-0.19	-1.6	-53	8G01	

Note 1: The rating applies when the transistor is mounted on an FR4 board (Cu area = 645 mm², glass-epoxy, t = 1.6 mm).

Note 2: Built-in SBD, VRRM = 30 V, IO = 0.7 A, VF = 0.4 V (MAX)@IF = 0.5 A, IR = 100 μA (MAX)@VR = 10 V

Note 3: Tc = 25°C

Note 4: Built-in HED, VRRM = 200 V, IF(AV) = 1 A

Note 5: Pch MOS VDS = -20 V, ID = -2 A, RON = 130 mΩ Max

• Contact the Toshiba sales representative for information about RoHS compliance before you purchase any components.

*: New product

++: Being planned

(Power-Mold Transistors (SC-63/64))

Part Number	Applications	Absolute Maximum Ratings (Ta = 25°C)				Complementary	Equivalent Product	Remarks
		V _{CEO} (V)	I _c (A)	P _c (W)	★P _c (W)			
2SA1225	Power amplification for driver	-160	-1.5	1.0	15	2SC2983	—	
2SC2983		160	1.5	1.0	15	2SA1225	—	
2SA1241	Power amplification	-50	-2.0	1.0	10	2SC3076	2SA1892	
2SC3076		50	2.0	1.0	10	2SA1241	2SC5029	
2SA1242	Strobe flash, power amplification	-20	-5.0	1.0	10	2SC3072 (★★)	2SA1893	
2SC3072		20	5.0	1.0	10	2SA1242 (★★)	2SC3420	
2SC4684		20	5.0	1.0	10	—	2SC5030	High β
2SA1244	High-current switching	-50	-5.0	1.0	20	2SC3074	2SA1905	
2SC3074		50	5.0	1.0	20	2SA1244	2SC5076	
2SA2097		-50	-5.0	1.0	20	—	—	High β
2SC5886		50	5.0	1.0	20	—	—	High β
2SC5886A		50	5	1.0	20	—	—	High β, V _{ceo} = 120 V
2SB905	TV vertical output, TV audio output (B) class	-150	-1.5	1.0	10	2SD1220	2SA1408	
2SD1220		150	1.5	1.0	10	2SB905	2SC3621	
2SB906	Low-frequency power amplification	-60	-3.0	1.0	20	2SD1221	2SB834	
2SD1221		60	3.0	1.0	20	2SB906	2SD880	
TTB002 *		-60	-3.0	1.0	30	—	—	
TTA003 *		-80	-3.0	—	10	—	—	
2SB907	Switching, power amplification	-40	-3.0	1.0	15	2SD1222	—	Darlington type
2SD1222		40	3.0	1.0	15	2SB907	—	Darlington type
2SC6076		80	3	—	10	—	—	
2SB908	Switching, power amplification	-80	-4.0	1.0	15	2SD1223	—	Darlington type
2SD1223		80	4.0	1.0	15	2SB908	—	Darlington type
2SC3474	Switching, solenoid drive	80	2.0	1.0	20	—	—	
2SC3303	Switching	80	5.0	1.0	20	—	2SC3258	
2SA2034	High-voltage switching	-400	-2	1.0	15	—	—	
2SA2184		-550	-1	—	10	—	—	
2SA2142		-600	-0.5	—	15	—	—	
2SC3075		400	0.8	1.0	10	—	2SC5208	
2SC5458		400	0.8	1.0	10	—	—	
2SC5548		370	2	1.0	15	—	—	
2SC5548A		400	2	1.0	15	—	—	
2SC6127		800	0.05	1.0	10	—	—	
2SC3405		800	0.8	1.0	20	—	—	
2SC5465		800	0.8	1.0	20	—	—	
2SC6142 *		375	1.5	1.1	—	—	—	
TTC003 *		400	1.5	1.1	—	—	—	
2SC6000	High-speed switching	50	7	1.0	20	—	—	
2SC6052		20	5	1.0	10	—	—	

★: T_c = 25°C

★★: hFE classification varies

• Contact the Toshiba sales representative for information about RoHS compliance before you purchase any components.

*: New product

(PW-Mini Transistors (SC-62))

Part Number		Absolute Maximum Ratings					Electrical Characteristics										Marking		Equivalent to TO-92MOD (TO-92)		Remarks/ Applications	
		Pc (W)	Pc (W)	Pc (W)	VCE0 (V)	Ic (A)	hFE		VCE (sat)			fr										
							Min	Max	VCE (V)	Ic (mA)	Max	Ic (mA)	Ib (mA)	(MHz)	VCE (V)	Ic (mA)						
NPN	PNP	(Note 1)	(Note 2)																			
2SC2881	2SA1201	0.5	1.0	—	120	0.8	80	240	5	100	1.0	500	50	120	5	100	C□	D□	2SC2235	2SA965	Audio driver	
2SC2882	2SA1202	0.5	1.0	—	80	0.4	70	240	2	50	0.4	200	20	120/100	10	10	E□	F□	(2SC1627)	(2SA817)	Low saturation	
2SC2883	2SA1203	0.5	1.0	—	30	1.5	100	320	2	500	2.0	1500	30	120	2	500	G□	H□	2SC2236	2SA966	Audio driver	
2SC2884	2SA1204	0.5	1.0	—	30	0.8	100	320	1	100	0.5/0.7	500	20	120	5	10	P□	R□	(2SC2120)	(2SA950)	Low saturation	
2SC3515	2SA1384	0.5	1.0	—	300	0.1	30	150	10	20	0.5	20	2	60	10	20	I□	J□	(2SC2551)	(2SA1091)	Low saturation	
2SC3803	2SA1483	0.5	1.0	—	45	0.2	40	240	1	10	0.3	100	10	200	10	10	V□	W□	—	—	Low saturation	
—	2SA1734	0.5	1.0	—	30	1.2	120	400	2	100	0.5	700	35	100	2	100	—	LB	—	—	Low saturation	
—	2SA1971	0.5	1.0	—	-400	-0.5	140	400	-5	-100	-1.0	-100	-10	35	-5	-50	—	AL	—	2SA1972	High-voltage	
2SD1784	—	0.5	1.0	—	30	1.5	4000	—	2	150	1.5	1000	1	—	—	—	XN	—	2SD1140	—	Driver (Darlington)	
2SC5785	—	—	—	1	10	2	400	1000	2	200	0.12	600	12	—	—	—	3E	—	—	—	Low saturation	
—	2SA2066	—	—	1	-10	-2	200	500	-2	-200	-0.19	-600	-20	—	—	—	—	4E	—	—	—	Low saturation
2SC5713	—	—	—	1	10	4	400	1000	2	500	0.15	1600	32	—	—	—	2C	—	—	—	Low saturation	
2SC5819	—	—	—	1	20	1.5	400	1000	2	150	0.12	500	10	—	—	—	3D	—	—	—	Low saturation	
—	2SA2069	—	—	1	-20	-1.5	200	500	-2	-150	-0.14	-500	-17	—	—	—	—	4D	—	—	—	Low saturation
2SC6125	—	—	—	1	20	4	180	390	2	500	0.20	1600	53	—	—	—	4L	—	—	—	High-speed switching	
2SC5714	—	—	—	1	20	4	400	1000	2	500	0.15	1600	32	—	—	—	2E	—	—	—	Low saturation	
—	2SA2059	—	—	1	-20	-3	200	500	-2	-500	-0.19	-1600	-53	—	—	—	—	4F	—	—	—	Low saturation
2SC6126	—	—	—	1	50	3	250	400	2	300	0.18	1000	33	—	—	—	4M	—	—	—	High-speed switching	
2SC5712	—	—	—	1	50	3	400	1000	2	300	0.14	1000	20	—	—	—	2A	—	—	—	Low saturation	
—	2SA2060	—	—	1	-50	-2	200	500	-2	-300	-0.20	-1000	-33	—	—	—	—	4G	—	—	—	Low saturation
2SC5810	—	—	—	1	50	1	400	1000	2	100	0.17	300	6	—	—	—	3C	—	—	—	Low saturation	
—	2SA2070	—	—	1	-50	-1	200	500	-2	-100	-0.2	-300	-10	—	—	—	—	4C	—	—	—	Low saturation
2SD2686	—	—	—	1	60±10	1	2000	—	2	1000	1.5	1000	1	—	—	—	3H	—	—	—	Darlington	
2SC6124	2SA2206	—	—	1	80	2	100	200	2	500	0.5	1000	100	150/100	2	500	4J	4K	—	—	Low saturation	
TTC005 *	—	—	—	1.1	285	1	100	200	5	100	1.0	600	75	—	—	—	4N	—	—	—	High-voltage	

Note 1: The hFE classification that appears instead of the □ shown in the Marking column will be one of the following: A, B, C, D, O, R or Y, according to the rank.

*: New product

Note 1: The rating applies when the transistor is mounted on a ceramic board (250 mm² x 0.8 mm).

Note 2: The rating applies when the transistor is mounted on a glass-epoxy board (645 mm² x 1.6 mm).

- Contact the Toshiba sales representative for information about RoHS compliance before you purchase any components.

(TSM Transistors)

Part Number	Absolute Maximum Ratings					hFE				VCE (sat) (V)			Marking	Remarks/ Applications
	NPN	VCE0 (V)	Ic (A)	ICP (A)	Pc (mW) (Note1)	Pc (mW) (Note1) t = 10s	Min	Max	VCE (V)	Ic (A)	Max	Ic (A)		
2SA2058	-10	-1.5	-2.5	500	750	200	500	-2	-0.2	-0.19	-0.6	-20	WM	Low saturation
2SA2065	-20	-1.5	-2.5	500	750	200	500	-2	-0.15	-0.14	-0.5	-17	WK	Low saturation
2SA2061	-20	-2.5	-4	625	1000	200	500	-2	-0.5	-0.19	-1.6	-53	WE	Low saturation
TTA007 *	-50	-1	-2	700	1100	200	500	-2	-0.1	-0.2	-0.3	-10	WH	Low saturation
2SA2056	-50	-2	-3.5	625	1000	200	500	-2	-0.3	-0.20	-1.0	-33	WF	Low saturation
2SC5755	10	2	3.5	500	750	400	1000	2	0.2	0.12	0.6	12	WL	Low saturation
2SC5784	20	1.5	2.5	500	750	400	1000	2	0.15	0.12	0.5	10	WJ	Low saturation
2SC5738	20	3.5	6	625	1000	400	1000	2	0.5	0.15	1.6	32	WD	Low saturation
2SC5976	30	3	5	625	1000	250	400	2	0.3	0.14	1.0	33	WW	Ultra-high-speed switching Low saturation voltage
2SC5906	30	4	7	800	1250	200	500	2	0.5	0.2	1.6	53	WP	Ultra-high-speed switching Low saturation voltage
2SC6062	30	5	10	800	1250	250	400	2	0.5	0.12	1.6	53	WR	Ultra-high-speed switching Low saturation voltage
TTC007 *	50	1	2	700	1100	400	1000	2	0.1	0.12	0.3	6	WG	Low saturation
2SC5692	50	2.5	4	625	1000	400	1000	2	0.3	0.14	1.0	20	WB	Low saturation
2SC6033	50	2.5	5	625	1000	250	400	2	0.3	0.18	1.0	33	WX	Ultra-high-speed switching Low saturation voltage
2SC5703	50	4	7	800	1250	400	1000	2	0.5	0.12	1.6	32	WA	Low saturation
2SD2719	60±10	0.8	3	800	1250	2000	—	2	1.0	1.5	1	1	WV	Darlington
2SC6061	120	1	2	625	1000	120	300	2	0.1	0.14	0.3	10	WN	Low saturation

Note 1: The rating applies when the transistor is mounted on an FR4 board (Cu area = 645 mm², glass-epoxy, t = 1.6 mm).

*: New product

- Contact the Toshiba sales representative for information about RoHS compliance before you purchase any components.

Radio-Frequency Bipolar Small-Signal Transistors

Radio-Frequency Bipolar Transistors

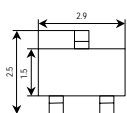
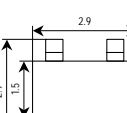
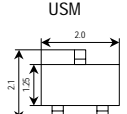
Part Number	Package	Applications	Absolute Maximum Ratings (Ta = 25°C)				Marking	TO-92 Equivalent Product	Remarks (Mini Transistors)
			V _{CEO} (V)	I _c (mA)	P _c (mW)	T _j (°C)			
2SC2714	 <p>S-MINI</p>	FM-band radio-frequency amps	30	20	150	125	Q□	2SC1923	fr = 550 MHz
2SC2715		AM-band frequency converter, FM-band IF amps	30	50	150	125	R□	2SC380TM	
2SC2716		AM-band radio-frequency amps	30	100	150	125	F□	2SC941TM	
2SC3123		VHF-band frequency converters, RF amps	20	50	150	125	HE	2SC3136	fr = 1.4 GHz
2SC5064		VHF/UHF-band low-noise amps	12	30	150	125	MA□	—	fr = 7 GHz
2SC5084		VHF/UHF-band low-noise amps	12	80	150	125	MC□	—	fr = 7 GHz
2SC5089		VHF/UHF-band low-noise amps	10	40	150	125	MD□	—	fr = 10 GHz
2SC5106		VHF/UHF-band oscillators	10	30	150	125	MF□	—	fr = 6 GHz
2SC5109		VHF/UHF-band oscillators	10	60	150	125	MG□	—	fr = 5 GHz
MT3S03A		VHF/UHF-band low-voltage operation, low phase noise	5	40	150	125	MR	—	fr = 10 GHz
MT3S04A		VHF/UHF-band low-voltage operation, low phase noise	5	40	150	125	AE	—	fr = 7 GHz
MT3S106		VHF/UHF-band low noise, low-distortion amps	6	80	700 (Note 1)	150	R2	—	fr = 13 GHz
2SC5087		 <p>SMQ</p>	VHF/UHF-band low-noise amps	12	80	150	125	C□	—
2SC5087R	VHF/UHF-band low-noise amps		12	80	150	125	ZP	—	fr = 8 GHz
2SC5092	VHF/UHF-band low-noise amps		10	40	150	125	D□	—	fr = 10 GHz
MT4S03A	VHF/UHF-band low-voltage operation, low phase noise		5	40	150	125	MR	—	fr = 10 GHz
MT4S04A	VHF/UHF-band low-voltage operation, low phase noise		5	40	150	125	AE	—	fr = 7 GHz
2SC4215	 <p>USM</p>	FM-band radio-frequency amps	30	20	100	125	Q□	2SC1923	fr = 550 MHz
2SC4250		VHF-band frequency converters, RF amps	20	50	100	125	HE	2SC3136	fr = 1.4 GHz
2SC5065		VHF/UHF-band low-noise amps	12	30	100	125	MA□	—	fr = 7 GHz
2SC5085		VHF/UHF-band low-noise amps	12	80	100	125	MC□	—	fr = 7 GHz
2SC5090		VHF/UHF-band low-noise amps	10	40	100	125	MD□	—	fr = 10 GHz
2SC5095		VHF/UHF-band low-noise amps	10	15	100	125	ME□	—	fr = 10 GHz
2SC5107		VHF/UHF-band oscillators	10	30	100	125	MF□	—	fr = 6 GHz
2SC5110		VHF/UHF-band oscillators	10	60	100	125	MG□	—	fr = 5 GHz
2SC5463		VHF/UHF-band low-noise amps	12	60	100	125	MX/MY	—	fr = 7 GHz
MT3S03AU		VHF/UHF-band low-voltage operation, low phase noise	5	40	100	125	MR	—	fr = 10 GHz
MT3S04AU		VHF/UHF-band low-voltage operation, low phase noise	5	40	100	125	AE	—	fr = 7 GHz
MT3S16U	UHF-band low-voltage oscillators and amps	5	60	100	125	T4	—	fr = 4 GHz	

□: Denotes a hFE class.

Note 1: Mounted on a ceramic board

- The products shown in bold are also manufactured in offshore fabs.
- Contact the Toshiba sales representative for information about RoHS compliance before you purchase any components.

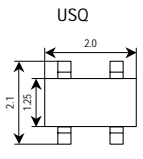
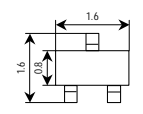
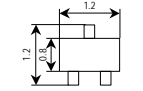
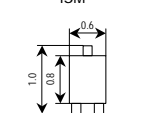
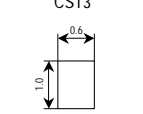
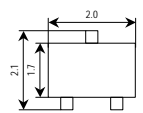
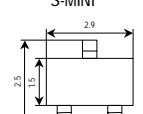
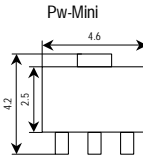
Part Number	Package	Applications	Absolute Maximum Ratings (Ta = 25°C)				Marking	TO-92 Equivalent Product	Remarks
			V _{CEO} (V)	I _C (mA)	P _C (mW)	T _J (°C)			
2SC5088	 USQ	VHF/UHF-band low-noise amps	12	80	100	125	MC□	—	fr = 7 GHz
2SC5319		VHF/UHF-band low-noise amps	5	20	100	125	MT	—	fr = 16 GHz
MT4S23U *		VHF/UHF-band low-noise amps	5	40	170 (Note 1)	150	MT	—	fr = 16 GHz
MT4S03AU		VHF/UHF-band low-voltage operation, low phase noise	5	40	100	125	MR	—	fr = 10 GHz
MT4S03BU *		VHF/UHF-band low-noise amps	5	40	175 (Note 1)	150	MR	—	fr = 12 GHz
MT4S06U		VHF/UHF-band low-voltage operation, low noise	5	15	60	125	AC	—	fr = 10 GHz
MT4S32U		VHF/UHF-band low-noise amps	4.5	15	67.5	125	U4	—	fr = 16 GHz
2SC4915	 SSM	FM-band radio-frequency amps	30	20	100	125	Q□	2SC1923	fr = 550 MHz
2SC5066		VHF/UHF-band low-noise amps	12	30	100	125	M1/M2	—	fr = 7 GHz
2SC5086		VHF/UHF-band low-noise amps	12	80	100	125	M5/M6	—	fr = 7 GHz
2SC5091		VHF/UHF-band low-noise amps	10	40	100	125	M7/M8	—	fr = 10 GHz
2SC5096		VHF/UHF-band low-noise amps	10	15	100	125	M9/MA	—	fr = 10 GHz
2SC5108		VHF/UHF-band oscillators	10	30	100	125	MB/MC	—	fr = 6 GHz
2SC5111		VHF/UHF-band oscillators	10	60	100	125	MD/ME	—	fr = 5 GHz
2SC5322		VHF/UHF-band low-noise amps	5	10	100	125	MU	—	fr = 7 GHz
2SC5464		VHF/UHF-band low-noise amps	12	60	100	125	MX/MY	—	fr = 7 GHz
MT3S03AS		VHF/UHF-band low-voltage operation, low phase noise	5	40	100	125	MR	—	fr = 10 GHz
MT3S04AS		VHF/UHF-band low-voltage operation, low phase noise	5	40	100	125	AE	—	fr = 7 GHz
MT3S06S		VHF/UHF-band low-voltage operation, low noise	5	15	60	125	AC	—	fr = 10 GHz
2SC4250FV		 VESM	VHF-band frequency converters, RF amps	20	50	150 (Note 1)	125	HE	2SC3136
MT3S03AFS	 ISM	VHF/UHF-band low-voltage operation, low phase noise	5	40	85 (Note 1)	125	00	—	fr = 10 GHz
MT3S04AFS		VHF/UHF-band low-voltage operation, low phase noise	5	40	85 (Note 1)	125	01	—	fr = 7 GHz
MT3S05FS		VHF/UHF-band low-voltage operation, low phase noise	5	40	85 (Note 1)	125	02	—	fr = 4.5 GHz
MT3S06FS		VHF/UHF-band low-voltage operation, low noise	5	15	85 (Note 1)	125	03	—	fr = 10 GHz
MT3S07FS		VHF/UHF-band low-voltage operation, low noise	5	25	85 (Note 1)	125	04	—	fr = 12 GHz
MT3S11FS		VHF/UHF-band low-voltage operation, low phase noise	6	40	85 (Note 1)	125	08	—	fr = 6 GHz
MT3S12FS		VHF/UHF-band low-voltage operation, low phase noise	6	40	85 (Note 1)	125	09	—	fr = 7 GHz
MT3S14FS		VHF/UHF-band low-voltage operation, low noise	2.5	30	85 (Note 1)	125	0H	—	fr = 11 GHz
MT3S16FS		UHF-band low-voltage oscillators and amps	5	60	85 (Note 1)	125	0K	—	fr = 4 GHz
MT3S35FS		VHF/UHF-band low-noise amps	4.5	24	100 (Note 1)	150	20	—	fr = 20 GHz
MT3S36FS		VHF/UHF-band low-noise amps	4.5	36	100 (Note 1)	150	21	—	fr = 19 GHz
MT3S37FS		VHF/UHF-band low-noise amps	4.5	50	100 (Note 1)	150	22	—	fr = 19 GHz
MT3S41FS		VHF/UHF-band low-noise amps	4.5	80	100 (Note 1)	150	26	—	fr = 15 GHz
MT3S11CT		 CST3	VHF/UHF-band low-voltage operation, low phase noise	6	40	105 (Note 1)	125	08	—
MT3S15TU *	 UFM	VHF/UHF-band low-noise amps, low-distortion amps	6	80	900 (Note 2)	150	T3	—	fr = 11.5 GHz
MT3S19TU *		VHF/UHF-band low-noise amps, low-distortion amps	6	80	900 (Note 2)	150	T6	—	fr = 11 GHz
MT3S20TU *		VHF/UHF-band low-noise amps, low-distortion amps	12	80	900 (Note 2)	150	MU	—	fr = 7 GHz
MT3S19 *	 S-MINI	VHF/UHF-band low-noise amps, low-distortion amps	6	80	800 (Note 2)	150	T6	—	fr = 12 GHz
MT3S20P *	 Pw-Mini	VHF/UHF-band low-noise amps, low-distortion amps	12	80	1800 (Note 2)	150	MU	—	fr = 7 GHz
MT3S21P *		VHF/UHF-band low-noise amps, low-distortion amps	6	80	1800 (Note 2)	150	T2	—	fr = 9 GHz
MT3S22P *		VHF/UHF-band low-noise amps, low-distortion amps	6	80	1800 (Note 2)	150	T5	—	fr = 8.5 GHz

□: Denotes a hFE class.

*: New product

Note 1: When mounted on a glass-epoxy PCB board

Note 2: Mounted on a ceramic board

- The products shown in bold are also manufactured in offshore fabs.
- Contact the Toshiba sales representative for information about RoHS compliance before you purchase any components.

Dual Radio-Frequency Bipolar Transistor

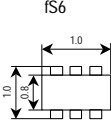
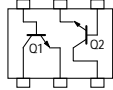
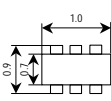
Part Number	Package	Absolute Maximum Ratings (Ta = 25°C)			Structure (Q1/Q2)	fr (Q1/Q2) (GHz)	◆ Internal Connections	Marking
		V _{CEO} (Q1/Q2) (V)	I _c (Q1/Q2) (mA)	P _c ★ (mW)				
MT6L63FS		5/6	25/40	110 (Note 1)	MT3S07FS/MT3S11FS	12/6		18
MT6L64FS		4.5/6	24/40	110 (Note 1)	MT3S35FS/MT3S11FS	19.5/6		19
MT6L65FS		4.5/6	36/40	110 (Note 1)	MT3S36FS/MT3S11FS	20/6		1F
MT6L67FS		4.5/6	36/80	110 (Note 1)	MT3S36FS/MT3S106FS	20/8.5		1J
MT6L68FS		5/6	15/40	110 (Note 1)	MT3S06FS/MT3S11FS	10/6		1K
MT6L71FS		5/6	25/40	105 (Note 1)	MT3S07FS/MT3S11AFS	12/6		1W
MT6L72FS		4.5/6	36/40	105 (Note 1)	MT3S36FS/MT3S11AFS	19/6		1X
MT6L75FS		5/6	25/80	110 (Note 1)	MT3S07FS/MT3S106FS	12/8.5		52
MT6L76FS		5/6	15/80	110 (Note 1)	MT3S06FS/MT3S106FS	10/8.5		53
MT6L77FS		6/6	40/80	110 (Note 1)	MT3S11FS/MT3S106FS	6/8.5		54
MT6L78FS	6/6	40/40	105 (Note 1)	MT3S11FS/MT3S11AFS	6/6	55		
MT6L77FST		6/6	40/80	140	MT3S11FS/MT3S106FS	6/8.5	54	

★P_c: Total power dissipation

◆The internal connection diagrams only show the general configurations of the circuits.

Note 1: When mounted on a glass-epoxy PCB board

- Contact the Toshiba sales representative for information about RoHS compliance before you purchase any components.

SiGe HBTs

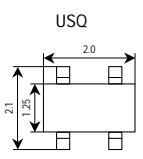
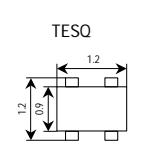
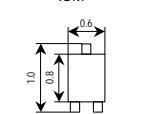
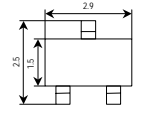
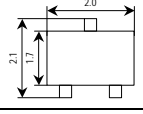
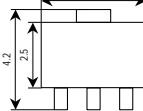
Part Number	Package	Applications	Absolute Maximum Ratings (Ta = 25°C)				Marking	Remarks
			V _{CEO} (V)	I _c (mA)	P _c (mW)	T _j (°C)		
MT4S100U		VHF/UHF-band low-noise amps	3	15	45	150	P6	fr = 22 GHz
MT4S101U		VHF/UHF-band low-noise amps	3	10	30	150	P7	fr = 21 GHz
MT4S102U		UHF/SHF-band low-noise amps	3	20	60	150	P8	fr = 24 GHz
MT4S104U		UHF/SHF-band low-noise amps	3	10	30	150	P1	fr = 23 GHz
MT4S200U		UHF/SHF-band low-noise amps	4	35	140 (Note 1)	150	P2	fr = 30 GHz
MT4S300U *		UHF/SHF-band low-noise amps	4	50	100	150	P3	fr = 26.5 GHz, high ESD immunity
MT4S301U *		UHF/SHF-band low-noise amps	4	35	100	150	P4	fr = 27.5 GHz, high ESD immunity
MT4S100T			VHF/UHF-band low-noise amps	3	15	45	150	P6
MT4S101T	VHF/UHF-band low-noise amps		3	10	30	150	P7	fr = 23 GHz
MT4S102T	UHF/SHF-band low-noise amps		3	20	60	150	P8	fr = 25 GHz
MT4S104T	UHF/SHF-band low-noise amps		3	10	30	150	P1	fr = 25 GHz
MT4S200T	UHF/SHF-band low-noise amps		4	35	100	150	P2	fr = 30 GHz
MT4S300T *	UHF/SHF-band low-noise amps		4	50	100	150	P3	fr = 26.5 GHz, high ESD immunity
MT4S301T *	UHF/SHF-band low-noise amps		4	35	100	150	P4	fr = 27.5 GHz, high ESD immunity
MT3S106FS			VHF/UHF-band low-voltage operation, low-noise amps	6	80	100 (Note 1)	150	41
MT3S111 *		VHF/UHF-band low-noise, low-distortion amps	6	100	700 (Note 2)	150	R5	fr = 11.5 GHz
MT3S113 *		VHF/UHF-band low-noise, low-distortion amps	5.3	100	800 (Note 2)	150	R7	fr = 12.5 GHz
MT3S111TU *		VHF/UHF-band low-noise, low-distortion amps	6	100	800 (Note 2)	150	R5	fr = 10 GHz
MT3S113TU *		VHF/UHF-band low-noise, low-distortion amps	5.3	100	900 (Note 2)	150	R7	fr = 11.2 GHz
MT3S111P *		VHF/UHF-band low-noise, low-distortion amps	6	100	1000 (Note 2)	150	R5	fr = 8 GHz
MT3S113P *		VHF/UHF-band low-noise, low-distortion amps	5.3	100	1600 (Note 2)	150	R7	fr = 7.7 GHz

Note 1: When mounted on a glass-epoxy PCB board

*: New product

Note 2: Mounted on a ceramic board

- The products shown in bold are also manufactured in offshore fabs.
- Contact the Toshiba sales representative for information about RoHS compliance before you purchase any components.

Radio-Frequency Small-Signal FETs

Radio-Frequency MOSFETs

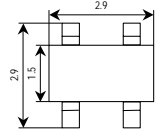
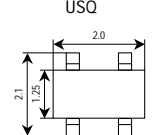
Part Number	Package	Applications	Electrical Characteristics (Ta = 25°C)					Marking	Equivalent Product (Leaded Type)
			V _{DS} (V)	I _D (mA)	P _D (mW)	I _{DSS} (mA)	Y _{fs} (mS) Typ.		
3SK291		UHF-band radio-frequency amps	12.5	30	150	0 to 0.1	26	UF	—
3SK292		VHF/UHF-band radio-frequency amps	12.5	30	150	0 to 0.1	23.5	UV	—
3SK293		UHF-band radio-frequency amps	12.5	30	100	0 to 0.1	26	UF	—
3SK294		VHF/UHF-band radio-frequency amps	12.5	30	100	0 to 0.1	23.5	UV	—

- Contact the Toshiba sales representative for information about RoHS compliance before you purchase any components.

Radio-Frequency Junction FETs

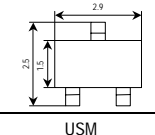
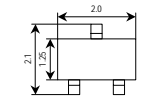
Part Number	Package	Applications	Electrical Characteristics (Ta = 25°C)					Marking	Equivalent Product (Leaded Type)
			V _{GSD} V _{GSD} ∅ (V)	I _G (mA)	P _D (mW)	I _{DSS} (mA)	Y _{fs} (mS) Typ.		
2SK210		FM-band radio-frequency amps	-18	10	100	3.0 to 24	7	Y□	—
2SK711		AM-band radio-frequency amps	-20 ∅	10	150	6 to 32	25	RB□	2SK709
2SK1875		AM-band radio-frequency amps	-20 ∅	10	100	6 to 32	25	RB□	2SK709

□: Denotes a loss class.

- The products shown in bold are also manufactured in offshore fabs.
- Contact the Toshiba sales representative for information about RoHS compliance before you purchase any components.

Radio-Frequency Power MOSFETs

Radio-Frequency Power MOSFETs

Part Number	Package	Applications	Absolute Maximum Ratings (Tc = 25°C)			Min	Po (W)		
			V _{DSS} (V)	P _D (W)	I _D (A)		Test Conditions		
							V _{DD} (V)	f (MHz)	P _i (W)
RFM08U9X *	PW-X	UHF/VHF Professional radios	36	20	5	7.5	9.6	520	0.5
2SK3075	PW-X		30	20	5	7.5	9.6	520	0.5
2SK3074	PW-MINI		30	3	1	0.63	9.6	520	0.02
RFM12U7X *	PW-X		20	20	4	11.5	7.2	520	1.0
RFM01U7P *	PW-MINI		20	3	1	1.0	7.2	520	0.1
2SK3476	PW-X		20	20	3	7.0	7.2	520	0.5
2SK3475	PW-MINI		20	3	1	0.63	7.2	520	0.02
RFM04U6P *	PW-MINI	GMRS	16	7	2	3.5	6.0	470	0.2
2SK4037	PW-X		12	20	3	3.55	6.0	470	0.3
2SK2854	PW-MINI	UHF/VHF Professional radios	10	0.5	0.5	0.2	6.0	849	0.02
2SK3079A	PW-X	FRS/GMRS	10	20	3	2.24	4.5	470	0.1
2SK3756	PW-MINI		7.5	3	1	1.26	4.5	470	0.1
2SK3078A	PW-MINI		10	3	0.5	0.63	4.5	470	0.1
2SK3077	USQ	Driver	10	0.25	0.1	0.032	4.8	915	0.001
RFM03U3CT *	RF-CST3	GMRS	16	7	2.5	2.3	3.6	520	0.1
RFM00U7U *	USQ	Driver	20	0.25	0.1	0.1	7.2	520	0.01

• Contact the Toshiba sales representative for information about RoHS compliance before you purchase any components.

*: New product

IGBTs

IGBTs (Discrete IGBTs)

Part Number	Applications	Features	Absolute Maximum Ratings (Ta = 25°C)				Package		Circuit Configuration (Note)	VCE(sat) Typ. @Ta = 25°C			If Typ. @Ta = 25°C		Remarks
			VCES (V)	Ic		Pc				Type	(V)	@Ic (A)	@VGE (V)	(μs)	
				DC (A)	Pulse (A)	Ta = 25°C (W)	Tc = 25°C (W)								
GT10J321	Power supplies (and UPS/PFC/Motor)	High-speed switching	600	10	20	—	29	TO-220NIS	Isolation, Through-hole	(2)	2.0	10	15	0.03	Low VCE (sat)
GT15J321				15	30	—	30	TO-220NIS	Isolation, Through-hole	(2)	1.9	15	15	0.03	
GT15J331				15	30	—	70	TO-220SM	SMD	(2)	1.75	15	15	0.10	
GT20J321				20	40	—	45	TO-220NIS	Isolation, Through-hole	(2)	2.0	20	15	0.04	
GT30J121				30	60	—	170	TO-3P(N)	Through-hole	(1)	2.0	30	15	0.05	
GT30J126				30	60	—	90	TO-3P(N)IS	Isolation, Through-hole	(1)	1.95	30	15	0.05	
GT30J324				30	60	—	170	TO-3P(N)	Through-hole	(2)	2.0	30	15	0.05	
GT50J121				50	100	—	240	TO-3P(LH)	Through-hole	(1)	2.0	50	15	0.05	
GT50J325				50	100	—	240	TO-3P(LH)	Through-hole	(2)	2.0	50	15	0.05	
GT10Q101	High ruggedness	High ruggedness	1200	10	20	—	140	TO-3P(N)	Through-hole	(1)	2.1	10	15	0.16	Inductive load
GT10Q301				10	20	—	140	TO-3P(N)	Through-hole	(2)	2.1	10	15	0.16	
GT15Q102				15	30	—	170	TO-3P(N)	Through-hole	(1)	2.1	15	15	0.16	
GT15Q301				15	30	—	170	TO-3P(N)	Through-hole	(2)	2.1	15	15	0.16	
GT25Q102				25	50	—	200	TO-3P(LH)	Through-hole	(1)	2.1	25	15	0.16	
GT25Q301				25	50	—	200	TO-3P(LH)	Through-hole	(2)	2.1	25	15	0.16	
GT5J301	Motor drives (and UPS/PFC)	High ruggedness	600	5	10	—	28	TO-220NIS	Isolation, Through-hole	(2)	2.1	5	15	0.15	
GT5J311				5	10	—	45	TO-220SM	SMD	(2)	2.1	5	15	0.15	
GT10J301				10	20	—	90	TO-3P(N)	Through-hole	(2)	2.1	10	15	0.15	
GT10J303				10	20	—	30	TO-220NIS	Isolation, Through-hole	(2)	2.1	10	15	0.15	
GT10J312				10	20	—	60	TO-220SM	SMD	(2)	2.1	10	15	0.15	
GT15J301				15	30	—	35	TO-220NIS	Isolation, Through-hole	(2)	2.1	15	15	0.15	
GT15J311				15	30	—	70	TO-220SM	SMD	(2)	2.1	15	15	0.15	
GT20J101				20	40	—	130	TO-3P(N)	Through-hole	(1)	2.1	20	15	0.15	
GT20J301				20	40	—	130	TO-3P(N)	Through-hole	(2)	2.1	20	15	0.15	
GT30J101				30	60	—	155	TO-3P(N)	Through-hole	(1)	2.1	30	15	0.15	
GT30J301				30	60	—	155	TO-3P(N)	Through-hole	(2)	2.1	30	15	0.15	
GT50J102				50	100	—	200	TO-3P(LH)	Through-hole	(1)	2.1	50	15	0.15	
GT50J301				50	100	—	200	TO-3P(LH)	Through-hole	(2)	2.1	50	15	0.15	
GT30J122				Power factor correction	Low VCE(sat) frequency switching	600	30	100	—	75	TO-3P(N)IS	Isolation, Through-hole	(1)	2.1	
GT30J322	IH rice cookers, IH cooktops, Microwave ovens, Induction heating equipment AC 200 V	Current resonance	30	100	—		75	TO-3P(N)IS	Isolation, Through-hole	(2)	2.1	50	15	0.25	Resistive load
GT35J321			37	100	—		75	TO-3P(N)IS	Isolation, Through-hole	(2)	1.9	50	15	0.19	
GT40J321			40	100	—		120	TO-3P(N)	Through-hole	(2)	2.0	40	15	0.11	
GT40J322			40	100	—		120	TO-3P(N)	Through-hole	(2)	1.7	40	15	0.20	
GT50J322			50	100	—		130	TO-3P(LH)	Through-hole	(2)	2.1	50	15	0.25	
GT50J322H			50	100	—		130	TO-3P(LH)	Through-hole	(2)	2.2	50	15	0.11	
GT50J327			50	100	—		140	TO-3P(N)	Through-hole	(2)	1.9	50	15	0.19	
GT50J328			50	120	—		140	TO-3P(N)	Through-hole	(2)	2.0	50	15	0.1	
GT60J321			60	120	—		200	TO-3P(LH)	Through-hole	(2)	1.55	60	15	0.30	
GT60J323			60	120	—		170	TO-3P(LH)	Through-hole	(2)	1.9	60	15	0.16	
GT60J323H			60	120	—		170	TO-3P(LH)	Through-hole	(2)	2.1	60	15	0.12	

• Contact the Toshiba sales representative for information about RoHS compliance before you purchase any components.

Note)

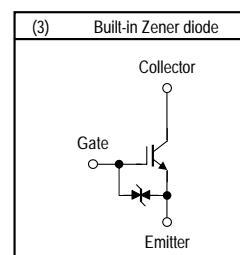
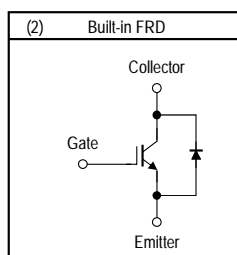
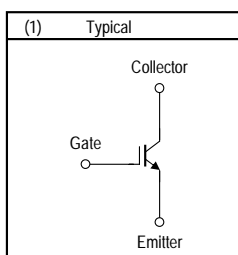

IGBT (Discrete IGBT) (Continued)

Part Number	Applications	Features	Absolute Maximum Ratings (Ta = 25°C)				Package		Circuit Configuration (Note)	VCE(sat) Typ. @Ta = 25°C			If Typ. @Ta = 25°C		Remarks	
			VCES (V)	Ic		Pc		Type		(V)	@Ic (A)	@VGE (V)	(μs)	Test Conditions		
				DC (A)	Pulse (A)	Ta = 25°C (W)	Tc = 25°C (W)									
GT15M321	IH rice cookers, IH cooktops, Microwave ovens, Induction heating equipment AC100 V	Voltage resonance	900	15	30	—	55	TO-3P(N)IS	Isolation, Through-hole	(2)	1.8	15	15	0.20	Resistive load	For small power
GT50M322				50	120	—	156	TO-3P(N)	Through-hole	(2)	2.1	60	15	0.25		
GT60M323				60	120	—	200	TO-3P(LH)	Through-hole	(2)	2.3	60	15	0.09		Fast switching
GT60M324				60	120	—	170	TO-3P(LH)	Through-hole	(2)	2.1	60	15	0.25		
GT60M324 *				60	120	—	254	TO-3P(N)	Through-hole	(2)	1.7	60	15	0.11		Tj = 175°C
GT50N321				50	120	—	156	TO-3P(N)	Through-hole	(2)	2.5	60	15	0.25		
GT50N322A				50	120	—	156	TO-3P(N)	Through-hole	(2)	2.2	60	15	0.1		Fast switching
GT50N324				50	120	—	150	TO-3P(N)	Through-hole	(2)	1.9	60	15	0.11		6th generation
GT60N321				60	120	—	170	TO-3P(LH)	Through-hole	(2)	2.3	60	15	0.25		
GT60N322				57	120	—	200	TO-3P(LH)	Through-hole	(2)	2.4	60	15	0.11		Fast switching
GT40Q321	IH rice cookers, IH cooktops, Microwave ovens, Induction heating equipment AC200 V		1200	42	80	—	170	TO-3P(N)	Through-hole	(2)	2.8	40	15	0.41		
GT40T321 *				40	80	—	230	TO-3P(N)	Through-hole	(2)	2.15	40	15	0.24	Tj = 175°C	
GT40T302 *				40	80	—	200	TO-3P(LH)	Through-hole	(2)	3.7	40	15	0.23	High VCES	
GT5G133 *	Digital still cameras, cell phone	Strobe flash (dimming control)	400	—	130	0.83	—	TSON-8	SMD	(3)	3.0	130	2.5	1.5	Resistive load	ICP = 130 A @VGE = 2.5V gate drive
GT8G132	Digital still cameras, single lens reflex cameras			—	150	1.1	—	SOP-8	SMD	(3)	2.3	150	4.0	1.6		ICP = 150 A @VGE = 4.0V gate drive
GT8G133				—	150	1.1	—	TSSOP-8	SMD	(3)	2.9	150	4.0	1.7		ICP = 150 A @VGE = 4.0V gate drive
GT8G134				—	150	1.1	—	TSSOP-8	SMD	(3)	3.4	150	2.5	1.2		ICP = 150 A @VGE = 2.5V gate drive
GT8G136				—	150	1.1	—	TSSOP-8	SMD	(3)	3.5	150	3.0	1.6		ICP = 150 A @VGE = 3.0V gate drive
GT10G131				—	200	1.9	—	SOP-8	SMD	(3)	2.3	200	4.0	1.8		ICP = 200 A @VGE = 4.0V gate drive
GT30F122		PDP-TV	PDP sustain, energy recovery and separation circuits	300	—	120	—	25	TO-220SIS	Isolation, Through-hole	(1)	2.4	120	15	0.21	5th generation
GT30F123	—				200	—	25	TO-220SIS	Isolation, Through-hole	(1)	2.1	120	15	0.15	6th generation	
GT30F124 *	—				200	—	25	TO-220SIS	Isolation, Through-hole	(1)	2.3	120	15	0.15	6th generation	
GT30F125 *	330				—	200	—	25	TO-220SIS	Isolation, Through-hole	(1)	1.9	120	15	0.15	6th generation
GT45F122	—				200	—	25	TO-220SIS	Isolation, Through-hole	(1)	2.2	120	15	0.2	5th generation	
GT45F123	—				200	—	26	TO-220SIS	Isolation, Through-hole	(1)	1.95	120	15	0.2	5th generation	
GT45F124	300				—	200	—	29	TO-220SIS	Isolation, Through-hole	(1)	1.7	120	15	0.22	5th generation
GT45F125	—				200	—	29	TO-220SIS	Isolation, Through-hole	(1)	1.45	120	15	0.4	5th generation	
GT45F127	—				200	—	26	TO-220SIS	Isolation, Through-hole	(1)	1.6	120	15	0.27	6th generation	

• Contact the Toshiba sales representative for information about RoHS compliance before you purchase any components.

*: New product

Note)

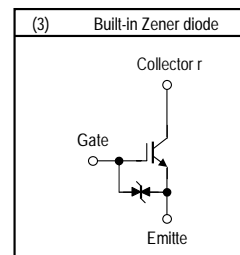
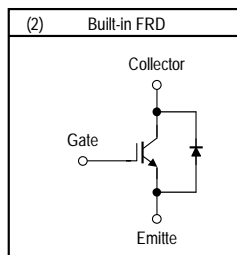
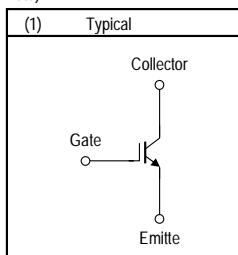

Part Number	Applications	Features	Absolute Maximum Ratings (Ta = 25°C)				Package		Circuit Configuration (Note)	VCE(sat) Typ. @Ta = 25°C			If Typ. @Ta = 25°C		Remarks	
			VCES (V)	Ic		Pc				Type	@Ic (V)	@VGE (V)	Test Conditions (μs)			
				DC (A)	Pulse (A)	Ta = 25°C (W)	Tc = 25°C (W)									
GT45F128 *	PDP-TV	PDP sustain, energy recovery and separation circuits	330	—	200	—	26	TO-220SIS	Isolation, Through-hole	(1)	1.45	120	15	0.27	Resistive load	6th generation
GT45F131			300	—	200	—	160	TO-220SM	SMD	(1)	1.7	120	15	0.22		5th generation
GT30G122			400	—	120	—	25	TO-220SIS	Isolation, Through-hole	(1)	2.6	120	15	0.25		5th generation
GT30G123			430	—	200	—	25	TO-220SIS	Isolation, Through-hole	(1)	2.2	120	15	0.20		6th generation
GT30G124 *				—	200	—	25	TO-220SIS	Isolation, Through-hole	(1)	2.5	120	15	0.23		6th generation
GT30G125 *			400	—	200	—	25	TO-220SIS	Isolation, Through-hole	(1)	2.1	120	15	0.16		6th generation
GT45G122				—	200	—	25	TO-220SIS	Isolation, Through-hole	(1)	2.4	120	15	0.28		5th generation
GT45G123				—	200	—	26	TO-220SIS	Isolation, Through-hole	(1)	2.1	120	15	0.23		5th generation
GT45G124				—	200	—	29	TO-220SIS	Isolation, Through-hole	(1)	1.9	120	15	0.27		5th generation
GT45G125			430	—	200	—	29	TO-220SIS	Isolation, Through-hole	(1)	1.6	120	15	0.5		5th generation
GT45G127				—	200	—	26	TO-220SIS	Isolation, Through-hole	(1)	1.7	120	15	0.37		6th generation
GT45G128 *			—	200	—	26	TO-220SIS	Isolation, Through-hole	(1)	1.55	120	15	0.41	6th generation		
GT45G131			400	—	200	—	160	TO-220SM	SMD	(1)	1.9	120	15	0.27		5th generation
GT30J124			600	—	200	—	26	TO-220SIS	Isolation, Through-hole	(1)	2.4	120	15	0.25		5th generation

• Contact the Toshiba sales representative for information about RoHS compliance before you purchase any components.

*: New product

Note)

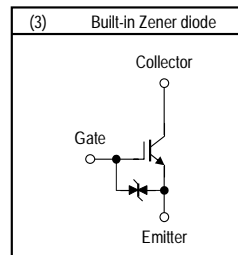
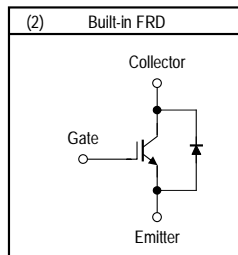
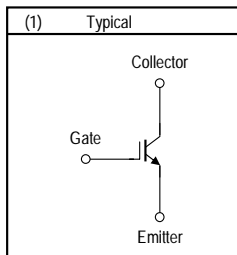

Phototransistors (for Optical Sensors)

Part Number	Part Number with Rank	Package	Electrical/Optical Characteristics (Ta = 25°C)								Applications
			Light Current			Dark Current		Peak Sensitive Wavelength (nm)	Half-Value Angle (°)	Impermeable to Visible Light	
			Min (μA)	Max (μA)	E (mW/cm ²)	Max (μA)	VCE (V)				
TPS601A(F)	—	TO-18CAN with lens	100	—	0.1	0.2	30	800	±10	—	
	TPS601A(A,F)		100	300							
	TPS601A(B,F)		200	600							
	TPS601A(C,F)		400	1200							
TPS610(F)	—	φ5	100	—	0.1	0.1	24	800	±8	—	
TPS611(F)	—	φ5	30	—	0.1	0.1	24	900	±8	●	
TPS615(F)	—	φ3	20	150	0.1	0.1	24	800	±30	—	
	TPS615(B,F)		34	85							
	TPS615(C,F)		60	150							
	TPS615(BC,F)		34	150							
TPS616(F)	—	φ3	10	75	0.1	0.1	24	900	±30	●	
	TPS616(B,F)		17	42.5							
	TPS616(C,F)		30	75							
	TPS616(BC,F)		17	75							
TPS622(F)	—	Small side-view package	27	—	0.1	0.1	24	870	±15	●	
	TPS622(A,F)		27	80							
	TPS622(B,F)		55	165							

Note: E = radiant incidence; VCE = collector-emitter voltage

- Contact the Toshiba sales representative for information about RoHS compliance before you purchase any components.

Toshiba America**Electronic Components, Inc.**

- Irvine, Headquarters
Tel: (949)623-2900 Fax: (949)474-1330
- Buffalo Grove (Chicago)
Tel: (847)484-2400 Fax: (847)541-7287
- Duluth/Atlanta
Tel: (770)931-3363 Fax: (770)931-7602
- El Paso
Tel: (915)771-8156
- Houston
Tel: (713)466-6277
- Marlborough
Tel: (508)481-0034 Fax: (508)481-8828
- Parsippany
Tel: (973)541-4715 Fax: (973)541-4716
- San Jose
Tel: (408)526-2400 Fax: (408)526-2410
- Wixom (Detroit)
Tel: (248)347-2607 Fax: (248)347-2602

Toshiba Electronics do Brasil Ltda.

Tel: (011)2539-6681 Fax: (011)2539-6675

Toshiba India Private Ltd.

Tel: (011)2331-8422 Fax: (011)2371-4603

Toshiba Electronics Europe GmbH

- Düsseldorf Head Office
Tel: (0211)5296-0 Fax: (0211)5296-400
- France Branch
Tel: (1)47282828 Fax: (1)42046491
- Italy Branch
Tel: (039)68701 Fax: (039)6870205
- Spain Branch
Tel: (91)660-6798 Fax: (91)660-6799
- U.K. Branch
Tel: (1252)5300 Fax: (1252)53-0250
- Sweden Branch
Tel: (8)704-0900 Fax: (8)80-8459

Toshiba Electronics Asia (Singapore) Pte. Ltd.

Tel: (6278)5252 Fax: (6271)5155

Toshiba Electronics Service (Thailand) Co., Ltd.

Tel: (02)501-1635 Fax: (02)501-1638

Toshiba Electronics Trading (Malaysia) Sdn. Bhd.

- Kuala Lumpur Head Office
Tel: (03)5631-6311 Fax: (03)5631-6307
- Penang Office
Tel: (04)226-8523 Fax: (04)226-8515

Toshiba Electronics Asia, Ltd.

- Hong Kong Head Office
Tel: 2375-6111 Fax: 2375-0969
- Beijing Office
Tel: (010)6590-8796 Fax: (010)6590-8791
- Chengdu Office
Tel: (028)8675-1773 Fax: (028)8675-1065
- Qingdao Office
Tel: (532)8579-3328 Fax: (532)8579-3329

Toshiba Electronics Shenzhen Co., Ltd.

Tel: (0755)2399-6897 Fax: (0755)2399-5573

Toshiba Electronics (Shanghai) Co., Ltd.

- Shanghai Head Office
Tel: (021)6841-0666 Fax: (021)6841-5002
- Hangzhou Office
Tel: (0571)8717-5004 Fax: (0571)8717-5013
- Nanjing Office
Tel: (025)8689-0070 Fax: (025)8689-0125

Toshiba Electronics (Dalian) Co., Ltd.

Tel: (0411)8368-6882 Fax: (0411)8369-0822

Tsurong Xiamen Xiangyu Trading Co., Ltd.

Tel: (0592)226-1398 Fax: (0592)226-1399

Toshiba Electronics Korea Corporation

- Seoul Head Office
Tel: (02)3484-4334 Fax: (02)3484-4302
- Daegu Office
Tel: (053)428-7610 Fax: (053)428-7617

Toshiba Electronics Taiwan Corporation

- Taipei Head Office
Tel: (02)2508-9988 Fax: (02)2508-9999

- ▶ Toshiba Corporation, and its subsidiaries and affiliates (collectively "TOSHIBA"), reserve the right to make changes to the information in this document, and related hardware, software and systems (collectively "Product") without notice.
 - ▶ This document and any information herein may not be reproduced without prior written permission from TOSHIBA. Even with TOSHIBA's written permission, reproduction is permissible only if reproduction is without alteration/omission.
 - ▶ Though TOSHIBA works continually to improve Product's quality and reliability, Product can malfunction or fail. Customers are responsible for complying with safety standards and for providing adequate designs and safeguards for their hardware, software and systems which minimize risk and avoid situations in which a malfunction or failure of Product could cause loss of human life, bodily injury or damage to property, including data loss or corruption. Before customers use the Product, create designs including the Product, or incorporate the Product into their own applications, customers must also refer to and comply with (a) the latest versions of all relevant TOSHIBA information, including without limitation, this document, the specifications, the data sheets and application notes for Product and the precautions and conditions set forth in the "TOSHIBA Semiconductor Reliability Handbook" and (b) the instructions for the application with which the Product will be used with or for. Customers are solely responsible for all aspects of their own product design or applications, including but not limited to (a) determining the appropriateness of the use of this Product in such design or applications; (b) evaluating and determining the applicability of any information contained in this document, or in charts, diagrams, programs, algorithms, sample application circuits, or any other referenced documents; and (c) validating all operating parameters for such designs and applications. **TOSHIBA ASSUMES NO LIABILITY FOR CUSTOMERS' PRODUCT DESIGN OR APPLICATIONS.**
 - ▶ Product is intended for use in general electronics applications (e.g., computers, personal equipment, office equipment, measuring equipment, industrial robots and home electronics appliances) or for specific applications as expressly stated in this document. Product is neither intended nor warranted for use in equipment or systems that require extraordinarily high levels of quality and/or reliability and/or a malfunction or failure of which may cause loss of human life, bodily injury, serious property damage or serious public impact ("Unintended Use"). Unintended Use includes, without limitation, equipment used in nuclear facilities, equipment used in the aerospace industry, medical equipment, equipment used for automobiles, trains, ships and other transportation, traffic signaling equipment, equipment used to control combustions or explosions, safety devices, elevators and escalators, devices related to electric power, and equipment used in finance-related fields. Do not use Product for Unintended Use unless specifically permitted in this document.
 - ▶ Do not disassemble, analyze, reverse-engineer, alter, modify, translate or copy Product, whether in whole or in part.
 - ▶ Product shall not be used for or incorporated into any products or systems whose manufacture, use, or sale is prohibited under any applicable laws or regulations.
 - ▶ The information contained herein is presented only as guidance for Product use. No responsibility is assumed by TOSHIBA for any infringement of patents or any other intellectual property rights of third parties that may result from the use of Product. No license to any intellectual property right is granted by this document, whether express or implied, by estoppel or otherwise.
 - ▶ **ABSENT A WRITTEN SIGNED AGREEMENT, EXCEPT AS PROVIDED IN THE RELEVANT TERMS AND CONDITIONS OF SALE FOR PRODUCT, AND TO THE MAXIMUM EXTENT ALLOWABLE BY LAW, TOSHIBA (1) ASSUMES NO LIABILITY WHATSOEVER, INCLUDING WITHOUT LIMITATION, INDIRECT, CONSEQUENTIAL, SPECIAL, OR INCIDENTAL DAMAGES OR LOSS, INCLUDING WITHOUT LIMITATION, LOSS OF PROFITS, LOSS OF OPPORTUNITIES, BUSINESS INTERRUPTION AND LOSS OF DATA, AND (2) DISCLAIMS ANY AND ALL EXPRESS OR IMPLIED WARRANTIES AND CONDITIONS RELATED TO SALE, USE OF PRODUCT, OR INFORMATION, INCLUDING WARRANTIES OR CONDITIONS OF MERCHANTABILITY, FITNESS FOR A PARTICULAR PURPOSE, ACCURACY OF INFORMATION, OR NONINFRINGEMENT.**
 - ▶ Product may include products using GaAs (Gallium Arsenide). GaAs is harmful to humans if consumed or absorbed, whether in the form of dust or vapor. Handle with care and do not break, cut, crush, grind, dissolve chemically or otherwise expose GaAs in Product.
 - ▶ Do not use or otherwise make available Product or related software or technology for any military purposes, including without limitation, for the design, development, use, stockpiling or manufacturing of nuclear, chemical, or biological weapons or missile technology products (mass destruction weapons). Product and related software and technology may be controlled under the Japanese Foreign Exchange and Foreign Trade Law and the U.S. Export Administration Regulations. Export and re-export of Product or related software or technology are strictly prohibited except in compliance with all applicable export laws and regulations.
 - ▶ Product may include products subject to foreign exchange and foreign trade control laws.
 - ▶ Please contact your TOSHIBA sales representative for details as to environmental matters such as the RoHS compatibility of Product. Please use Product in compliance with all applicable laws and regulations that regulate the inclusion or use of controlled substances, including without limitation, the EU RoHS Directive. TOSHIBA assumes no liability for damages or losses occurring as a result of noncompliance with applicable laws and regulations.
- In addition to the above, the following are applicable only to development tools.
- ▶ Though TOSHIBA works continually to improve Product's quality and reliability, Product can malfunction or fail. Use the Product in a way which minimizes risk and avoid situations in which a malfunction or failure of Product could cause loss of human life, bodily injury or damage to property, including data loss or corruption. For using the Product, customers must also refer to and comply with the latest versions of all relevant TOSHIBA information, including without limitation, this document, the instruction manual, the specifications, the data sheets for Product.
 - ▶ Product is provided solely for the purpose of performing the functional evaluation of a semiconductor product. Please do not use Product for any other purpose, including without limitation, evaluation in high or low temperature or humidity, and verification of reliability.
 - ▶ Do not incorporate Product into your products or system. Products are for your own use and not for sale, lease or other transfer.