

# SBD Type : 31DQ04

## OUTLINE DRAWING

### FEATURES

- \* Low Forward Voltage Drop
- \* Low Power Loss, High Efficiency
- \* High Surge Capability
- \* 30volts trough 100volts Types Available

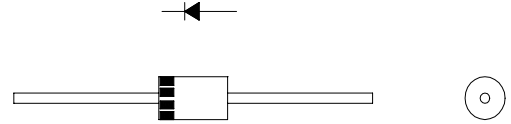

### Maximum Ratings

Approx Net Weight:1.18g

Rating		Symbol	31DQ04			Unit
Repetitive Peak Reverse Voltage		$V_{RRM}$	40			V
Non-repetitive Peak Reverse Voltage		$V_{RSM}$	45			V
Average Rectified Output Current	Without Fin or P.C.Board	$I_O$	1.7	$T_a=32^{\circ}C$	Half Sine Wave Resistive Load	A
	With Fin *1		3.0	$T_a=53^{\circ}C$		
RMS Forward Current		$I_{F(RMS)}$	4.71			A
Surge Forward Current		$I_{FSM}$	120	Half Sine Wave,1cycle,Non-repetitive		A
Operating JunctionTemperature Range		$T_{jw}$	- 40 to + 150			$^{\circ}C$
Storage Temperature Range		$T_{stg}$	- 40 to + 150			$^{\circ}C$

### Electrical • Thermal Characteristics

Characteristics	Symbol	Conditions	Min	Typ	Max	Unit
Peak Reverse Current	$I_{RM}$	$T_j= 25^{\circ}C, V_{RM}= V_{RRM}$	-	-	3	mA
Peak Forward Voltage	$V_{FM}$	$T_j= 25^{\circ}C, I_{FM}= 3 A$	-	-	0.55	V
Thermal Resistance(Junction to Ambient)	$R_{th(j-a)}$	Without Fin or P.C.Board	-	-	80	$^{\circ}C/W$
		With Fin *1			34	

\*1 :20x20x1t(mm) Copper plates, L=5mm, Both Sides

31DQ\_ OUTLINE DRAWING (Dimensions in mm)

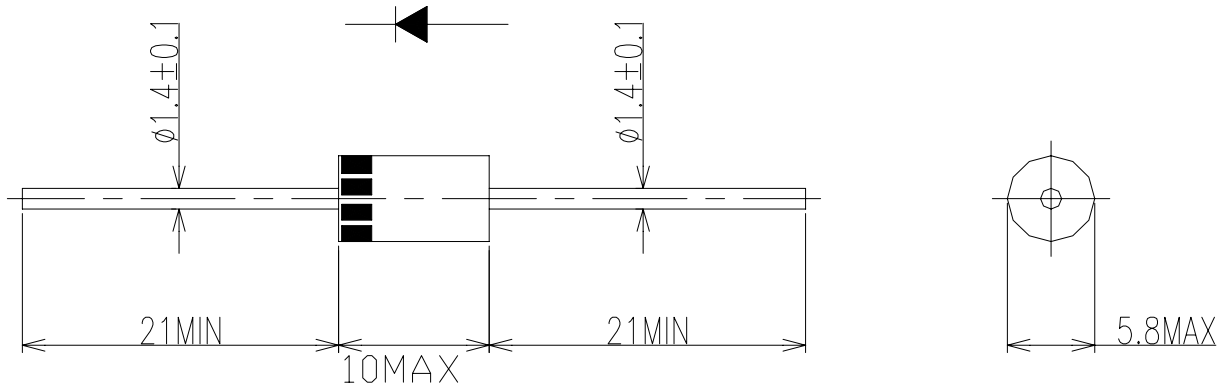

FORWARD CURRENT VS. VOLTAGE

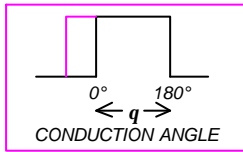
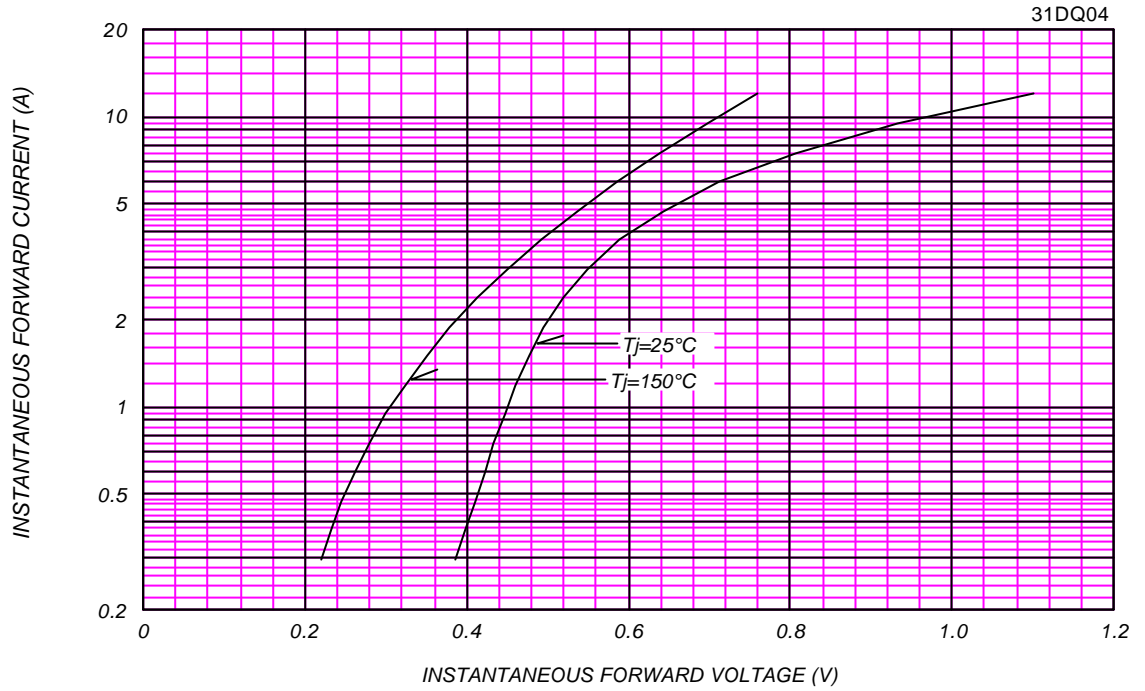

AVERAGE FORWARD POWER DISSIPATION

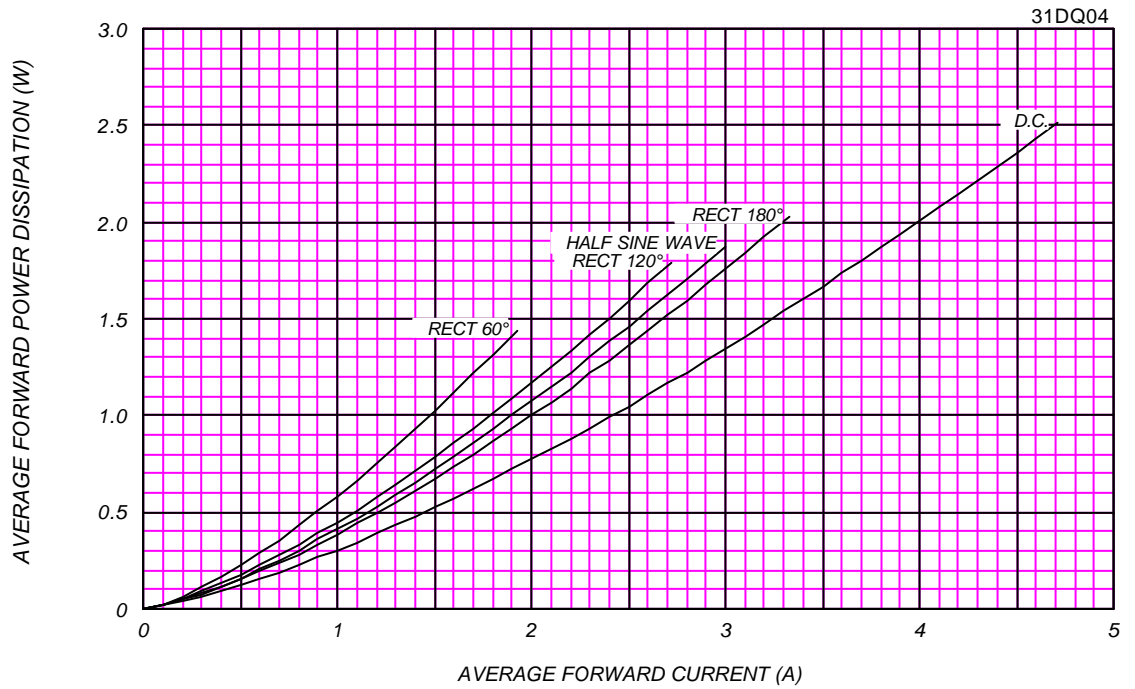

PEAK REVERSE CURRENT VS. PEAK REVERSE VOLTAGE

T<sub>j</sub> = 150 °C

31DQ04

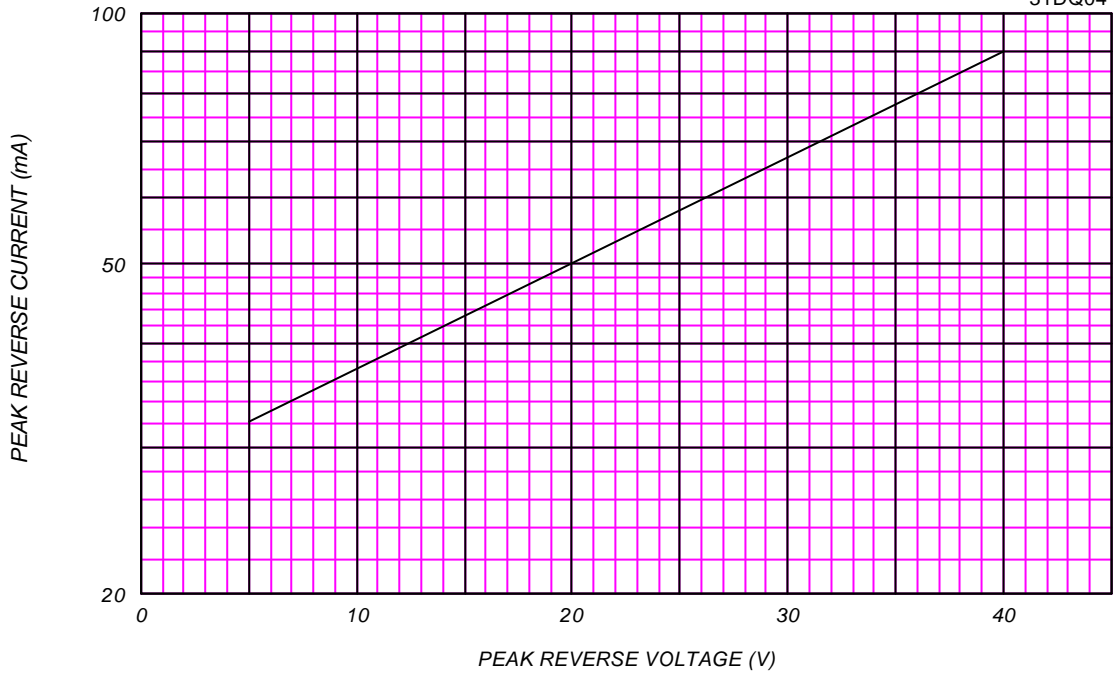

AVERAGE REVERSE POWER DISSIPATION

31DQ04

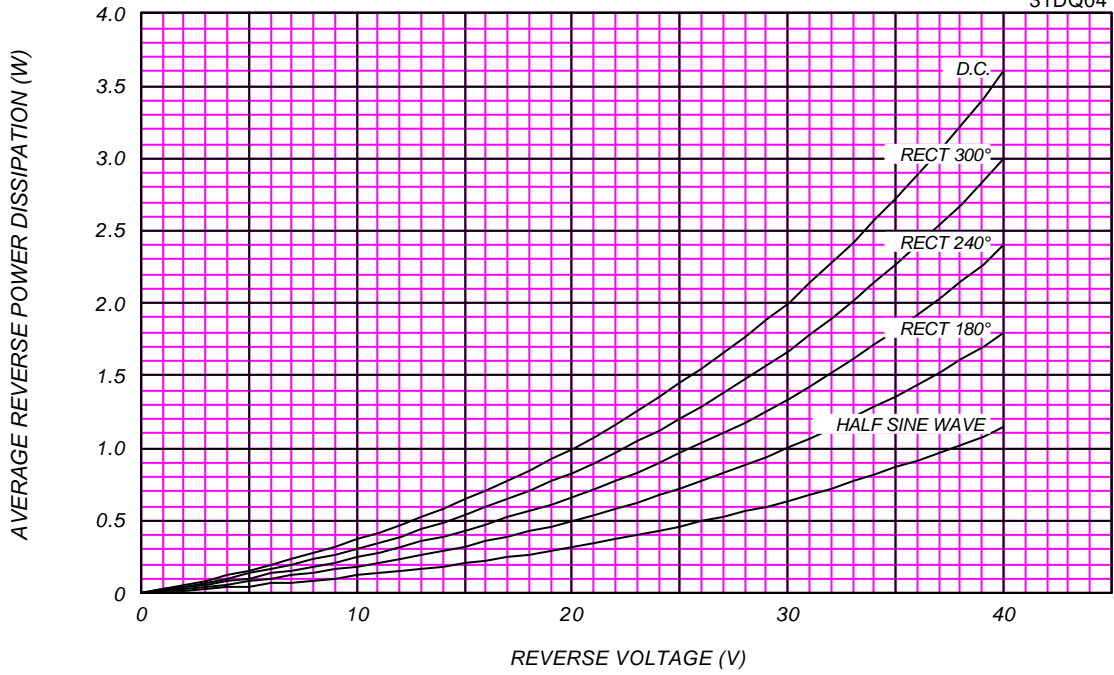

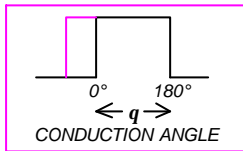

### AVERAGE FORWARD CURRENT VS. AMBIENT TEMPERATURE

Without Fin or P.C. Board,  $V_{RM}=40V$

31DQ04

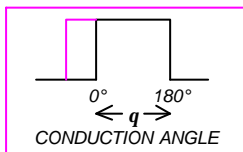
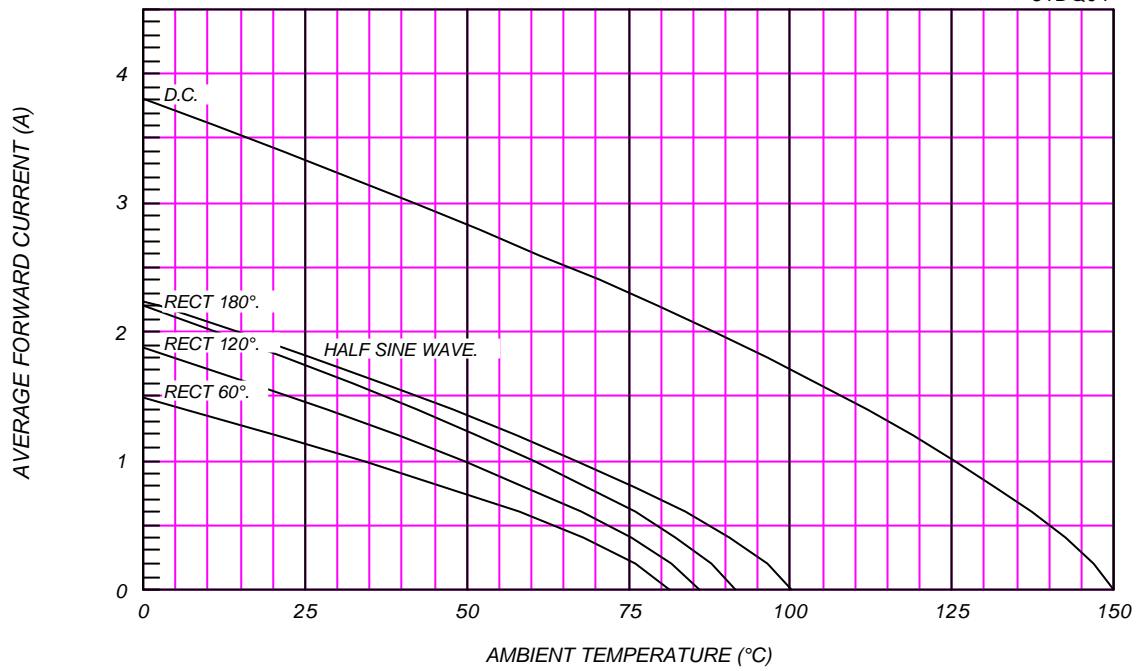

### AVERAGE FORWARD CURRENT VS. AMBIENT TEMPERATURE

With Cu Fin (20x20x1t, L=5mm, Both Sides),  $V_{RM}=40V$

31DQ04

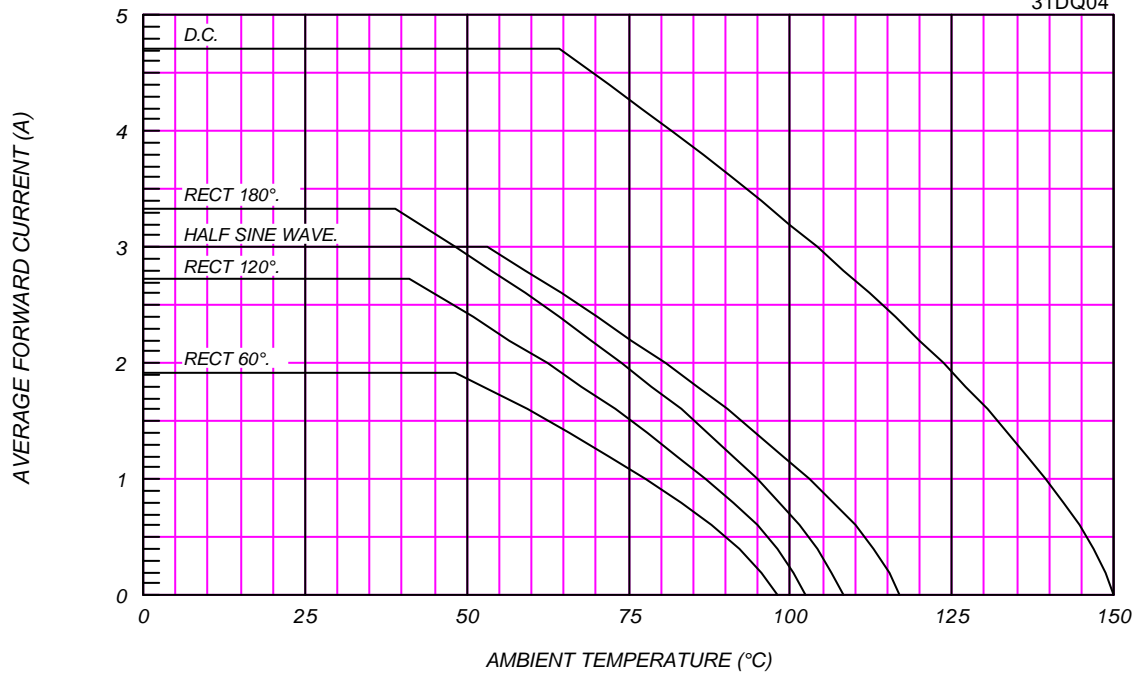

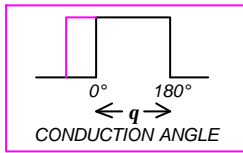

### AVERAGE FORWARD CURRENT VS. LEAD TEMPERATURE

$V_{RM} = 40\text{ V}$

31DQ04

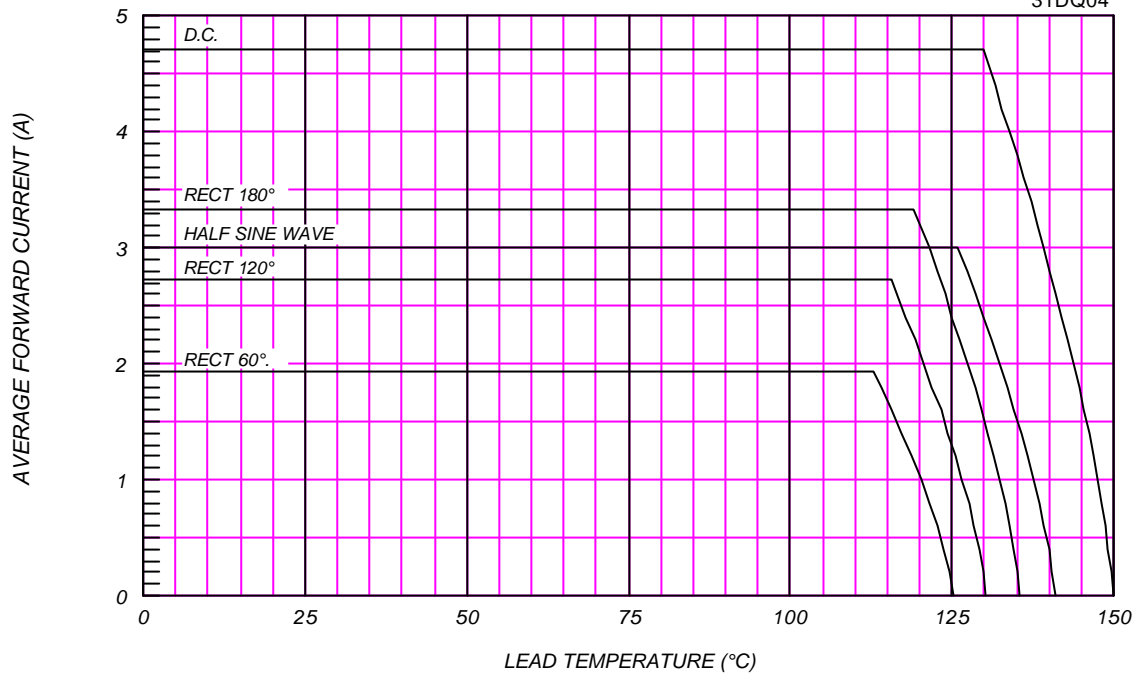

### SURGE CURRENT RATINGS

$f = 50\text{ Hz}$ , Half Sine Wave, Non-Repetitive, No Load

31DQ04

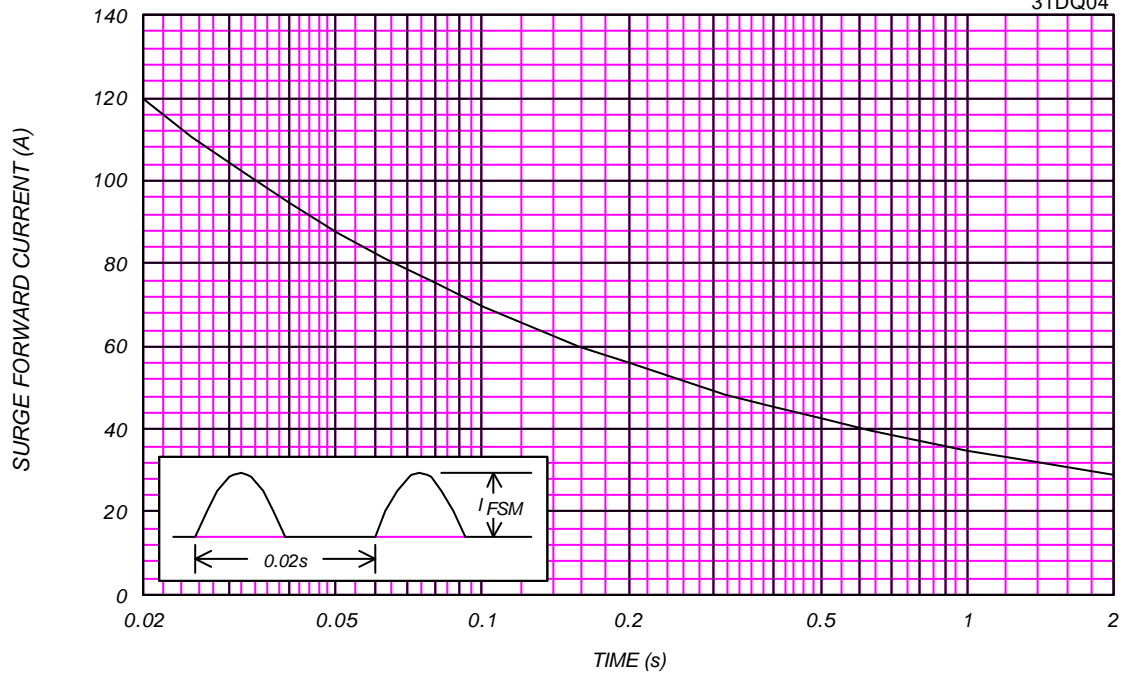

### JUNCTION CAPACITANCE VS. REVERSE VOLTAGE

$T_j = 25^\circ\text{C}$ ,  $V_m = 20\text{mV}_{\text{RMS}}$ ,  $f = 100\text{kHz}$ , Typical Value

31DQ04

