

3KP SERIES

GLASS PASSIVATED JUNCTION TRANSIENT VOLTAGE SUPPRESSOR

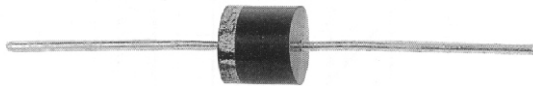

**CHENG-YI
ELECTRONIC**



VOLTAGE 6.8 to 144 VOLTS
400 WATT PEAK POWER
1.0 WATTS STEADY STATE

FEATURES

- Plastic package has Underwrites Laboratory Flammability Classification 94V-0
- Glass passivated junction
- 3000W Peak Pulse Power capability on 10/1000 μ s waveform
- Excellent clamping capability
- Repetition rate (Duty Cycle):0.5%
- Low incremental surge resistance
- Fast response time: typically less than 1.0 ps from 0 volts to BV min.
- Typical I_D less than 1 μ A above 10V
- High temperature soldering guaranteed: 300°C/10 seconds /.375",(9.5mm) lead length/51bs.,(2.3kg) tension

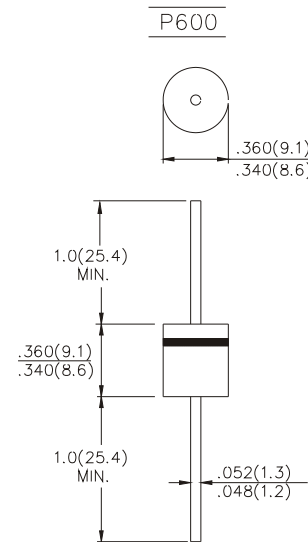

Dimensions in inches and (millimeters)

MECHANICAL DATA

- Case:Molded plastic over glass passivated junction
- Terminals:Plated Axial leads, solderable per MIL-STD-750, Method 2026
- Polarity:Color band denote positive end (cathode)
- Mounting Position:Any
- Weight:0.07 ounces, 2.1gram

MAXIMUM RATINGS AND ELECTRICAL CHARACTERISTICS

Ratings at 25°C ambient temperature unless otherwise specified.

RATINGS	SYMBOL	VALUE	UNITS
Peak Pulse Power Dissipation on 10/1000 μ s waveform (NOTE 1, Fig.1)	P_{PPM}	Minimum 3000	Watts
Peak Pulse Current of on 10/1000 μ s waveform (NOTE 1, Fig.3)	P_{PPM}	SEE TABLE 1	Amps
Steady Power Dissipation at $T_L=75^\circ\text{C}$ Lead Lengths .375",(9.5mm)(NOTE 2)	$P_{M(AV)}$	8.0	Watts
Peak Forward Surge Current 8.3ms Single Half Sine-Wave Superimposed on Rated Load(JEDEC Method)(NOTE 3)	I_{FSM}	250	Amps
Operating Junction and Storage Temperature Range	T_J, T_{STG}	-55 to + 175	$^\circ\text{C}$

- Notes: 1. Non-repetitive current pulse, per Fig.3 and derated above $T_A=25^\circ\text{C}$ per Fig.2
2. Mounted on Copper Leaf area of 0.79 in² (20mm²)
3. Measured on 8.3ms single half sine-wave or equivalent square wave,
Duty Cycle=4 pulses per minutes maximum.

3KP SERIES

GLASS PASSIVATED JUNCTION TRANSIENT VOLTAGE SUPPRESSOR



**CHENG-YI
ELECTRONIC**

RATING AND CHARACTERISTICS CURVES 3KP SERIES

Fig. 1 - PEAK PULSE POWER VS PULSE TIME

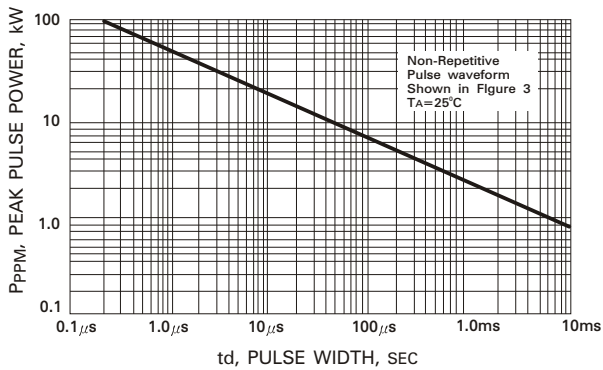

Fig. 2 - PULSE DERATING CURVE

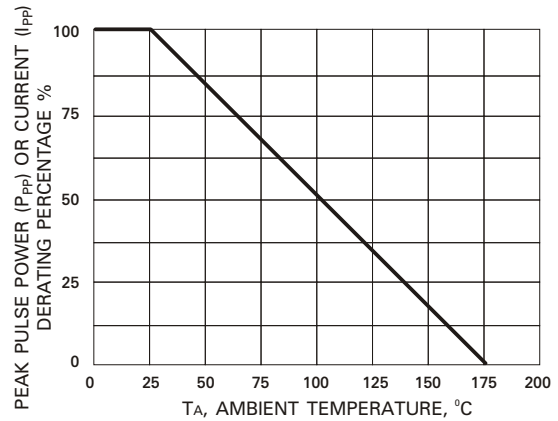

Fig. 3 - PULSE WAVEFORM

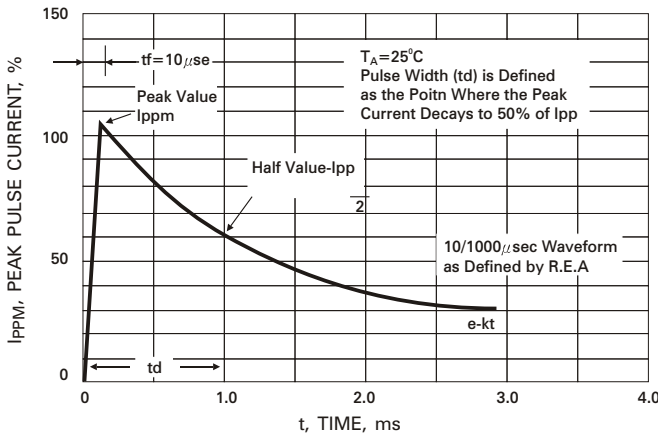

Fig. 4 - TYPICAL CAPACITANCE VS STAND-OFF VOLTAGE

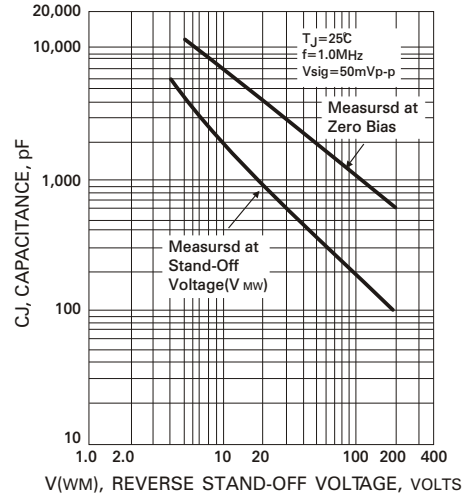

Fig. 5 - STEADY STATE POWER DERATING CURVE

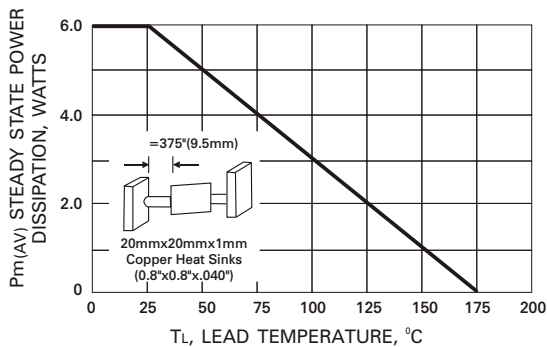

Fig. 6 - MAXIMUM NON-REPETITIVE PEAK FORWARD SURGE CURRENT

