

Glass Passivated Junction Transient Voltage Suppressor

Stand-Off Voltage - 5.0 to 220 Volts

3000 Watt Peak Pulse Power

Features

- Plastic package has Underwriters Laboratory
- Flammability Classification 94V-0
- Glass passivated junction
- 3000W Peak Pulse Power capability on 10/1000 μ s waveform
- Excellent clamping capability
- Repetition rate (duty cycle):0.05%
- Low incremental surge resistance
- Fast response time: typically less than 1.0ps from 0 Volts to B_V min.
- Typical I_R less than 2A above 10V
- High temperature soldering guaranteed: 265°C/10 seconds/.375", (9.5mm) lead length, 5lbs., (2.3kg) tension
- Pb-free plated

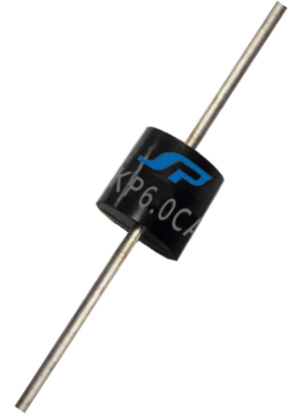

Mechanical Data

- **Case:** JMolded plastic over glass passivated junction
- **Terminals:** Solderable per MIL-STD-750, Method 2026
- **Polarity:** Color band denotes positive end (cathode) except Bipolar
- **Mounting Position:** Any
- **Weight:** 0.07 ounce, 2.1 grams

Devices For Bipolar Application

- For Bidirectional use C or CA Suffix for types 3KP5.0 thru types 3KP220 (e.g. 3KP5.0C , 3KP220CA)
- Electrical characteristics apply in both directions

Maximum Ratings And Characteristics

Ratings at 25°C ambient temperature unless otherwise specified.

RATING	SYMBOL	VALUE	UNITS
Peak Pulse Power Dissipation on 10/1000 μ s waveform (Note 1, FIG.1)	P_{PPM}	Minimum 3000	Watts
Peak Pulse Current of on 10/1000 μ s waveform (Note 1, FIG.3)	I_{PPM}	SEE TABLE 1	Amps
Steady State Power Dissipation at $T_L = 75^\circ\text{C}$, Lead lengths. 375", (9.5mm) (Note 2)	$P_{M(AV)}$	7	Watts
Peak Forward Surge Current, 8.3ms Single Half Sine-Wave Superimposed on Rated Load, (JEDEC Method) (Note3)	I_{FSM}	300	Amps
Operating junction and Storage Temperature Range	T_J, T_{STG}	-55 to +175	°C

Notes :

1. Non-repetitive current pulse , per Fig. 3 and derated above $T_A = 25^\circ\text{C}$ per Fig. 2 .
2. Mounted on Copper Pad area of 1.6×1.6" (40×40mm) per Fig. 5
3. 8.3ms single half sine-wave , or equivalent square wave, Duty cycle = 4 pulses per minutes maximum.

Dimensions

Case Style P600

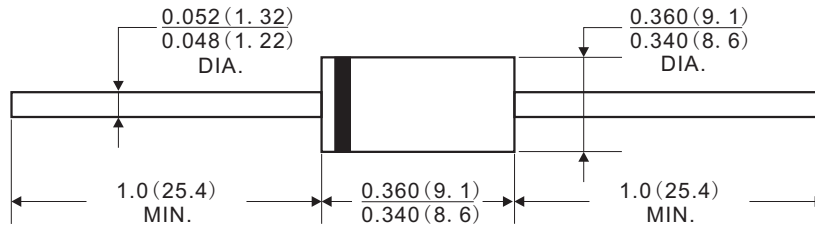

Dimensions in inches and (millimeters)

Electrical Characteristics

TABLE 1

3KP Part Number		Reverse Stand-Off Voltage	Breakdown Voltage @IT	Breakdown Voltage @IT	Test Current	Maximum Clamping Voltage @Ipp	Peak Pulse Current	Reverse Leakage @VRWM
UNI-Polar	BI-Polar	VRWM(V)	VBR(V)Min.	VBR(V)Max.	IT(mA)	Vc(V)	Ipp(A)	IR(μA)
3KP5.0A	3KP5.0CA	5.0	6.40	7.00	10	9.2	326.1	800
3KP6.0A	3KP6.0CA	6.0	6.67	7.37	10	10.3	291.3	800
3KP6.5A	3KP6.5CA	6.5	7.22	7.98	10	11.2	267.9	500
3KP7.0A	3KP7.0CA	7.0	7.78	8.60	10	12.0	250.0	200
3KP7.5A	3KP7.5CA	7.5	8.33	9.21	1	12.9	232.6	100
3KP8.0A	3KP8.0CA	8.0	8.89	9.83	1	13.6	220.6	50
3KP8.5A	3KP8.5CA	8.5	9.44	10.40	1	14.4	208.3	20
3KP9.0A	3KP9.0CA	9.0	10.00	11.10	1	15.4	194.8	10
3KP10A	3KP10CA	10.0	11.10	12.30	1	17.0	176.5	5
3KP11A	3KP11CA	11.0	12.20	13.50	1	18.2	164.8	2
3KP12A	3KP12CA	12.0	13.30	14.70	1	19.9	150.8	2
3KP13A	3KP13CA	13.0	14.40	15.90	1	21.5	139.5	2
3KP14A	3KP14CA	14.0	15.60	17.20	1	23.2	129.3	2
3KP15A	3KP15CA	15.0	16.70	18.50	1	24.4	123.0	2
3KP16A	3KP16CA	16.0	17.80	19.70	1	26.0	115.4	2
3KP17A	3KP17CA	17.0	18.90	20.90	1	27.6	108.7	2
3KP18A	3KP18CA	18.0	20.00	22.10	1	29.2	102.7	2
3KP20A	3KP20CA	20.0	22.20	24.50	1	32.4	92.6	2
3KP22A	3KP22CA	22.0	24.40	26.90	1	35.5	84.5	2
3KP24A	3KP24CA	24.0	26.70	29.50	1	38.9	77.1	2
3KP26A	3KP26CA	26.0	28.90	31.90	1	42.1	71.3	2
3KP28A	3KP28CA	28.0	31.10	34.40	1	45.4	66.1	2

Notes :

1. For bidirectional type having VRWM of 10 volts and less, the IR limit is double
2. For parts with A, the VBR is ± 5%

Electrical Characteristics

TABLE1

3KP Part Number		Reverse Stand-Off Voltage	Breakdown Voltage @IT	Breakdown Voltage @IT	Test Current	Maximum Clamping Voltage @Ipp	Peak Pulse Current	Reverse Leakage @VRWM
UNI-Polar	BI-Polar	VRWM(V)	VBR(V)Min.	VBR(V)Max.	IT(mA)	Vc(V)	Ipp(A)	IR(μA)
3KP30A	3KP30CA	30.0	33.30	36.80	1	48.4	62.0	2
3KP33A	3KP33CA	33.0	36.70	40.60	1	53.3	56.3	2
3KP36A	3KP36CA	36.0	40.00	44.20	1	58.1	51.6	2
3KP40A	3KP40CA	40.0	44.40	49.10	1	64.5	46.5	2
3KP43A	3KP43CA	43.0	47.80	52.80	1	69.4	43.2	2
3KP45A	3KP45CA	45.0	50.00	55.30	1	72.7	41.3	2
3KP48A	3KP48CA	48.0	53.30	58.90	1	77.4	38.8	2
3KP51A	3KP51CA	51.0	56.70	62.70	1	82.4	36.4	2
3KP54A	3KP54CA	54.0	60.00	66.30	1	87.1	34.4	2
3KP58A	3KP58CA	58.0	64.40	71.20	1	93.6	32.1	2
3KP60A	3KP60CA	60.0	66.70	73.70	1	96.8	31.0	2
3KP64A	3KP64CA	64.0	71.10	78.60	1	103.0	29.1	2
3KP70A	3KP70CA	70.0	77.80	86.00	1	113.0	26.5	2
3KP75A	3KP75CA	75.0	83.30	92.10	1	121.0	24.8	2
3KP78A	3KP78CA	78.0	86.70	95.80	1	126.0	23.8	2
3KP85A	3KP85CA	85.0	94.40	104.00	1	137.0	21.9	2
3KP90A	3KP90CA	90.0	100.00	111.00	1	146.0	20.5	2
3KP100A	3KP100CA	100.0	111.00	123.00	1	162.0	18.5	2
3KP110A	3KP110CA	110.0	122.00	135.00	1	177.0	16.9	2
3KP120A	3KP120CA	120.0	133.00	147.00	1	193.0	15.5	2
3KP130A	3KP130CA	130.0	144.00	159.00	1	209.0	14.4	2
3KP150A	3KP150CA	150.0	167.00	185.00	1	243.0	12.3	2
3KP160A	3KP160CA	160.0	178.00	197.00	1	259.0	11.6	2
3KP170A	3KP170CA	170.0	189.00	209.00	1	275.0	10.9	2
3KP180A	3KP180CA	180.0	200.00	221.00	1	289.0	10.4	2
3KP190A	3KP190CA	190.0	211.00	233.00	1	310.0	9.7	2
3KP200A	3KP200CA	200.0	222.00	246.00	1	329.2	9.1	2
3KP210A	3KP210CA	210.0	233.00	258.00	1	349.5	8.6	2
3KP220A	3KP220CA	220.0	244.00	270.00	1	371.1	8.1	2

Notes :

1. For bidirectional type having VRWM of 10 volts and less, the IR limit is double
2. For parts with A, the VBR is ± 5%

Rating And Characteristic Curves

Fig.1 Peak Pulse Power Rating Curve

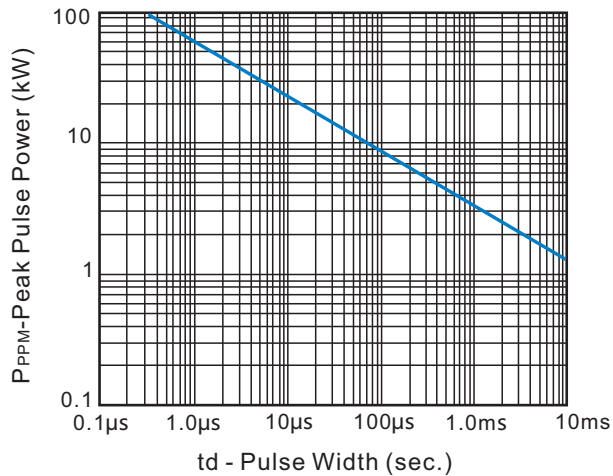

Fig.2 Pulse Derating Curve

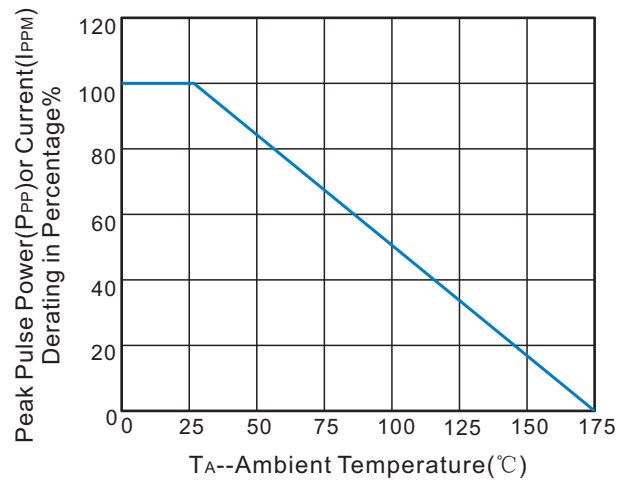

Fig.3 Pulse Waverform

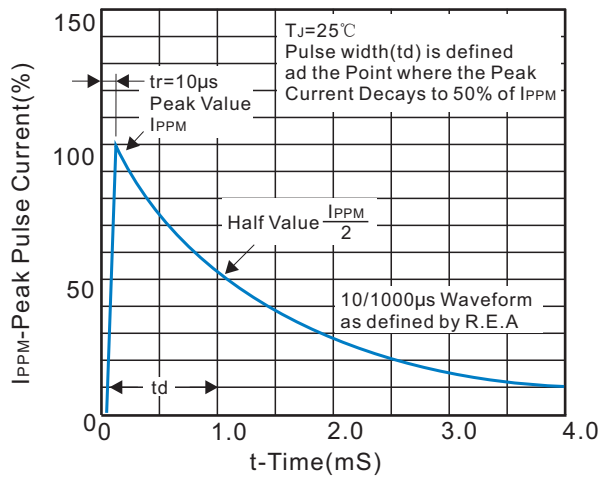

Fig.4 Typical Junction Capacitance

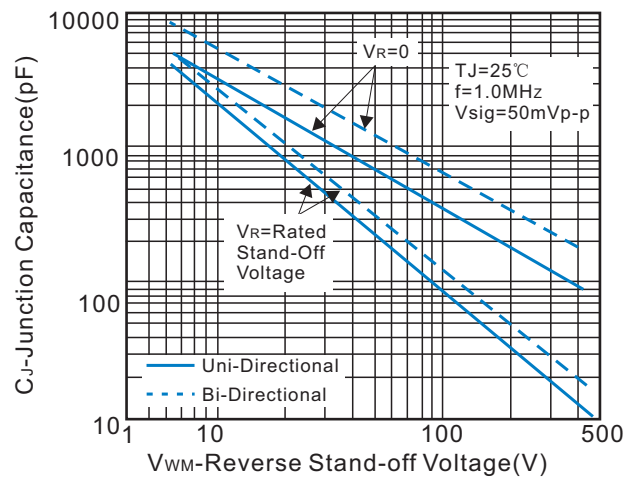

Fig.5 Steady State Power Dissipation Derating Curve

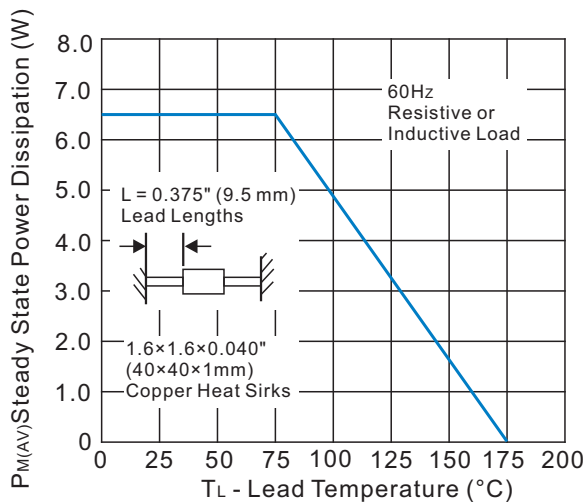
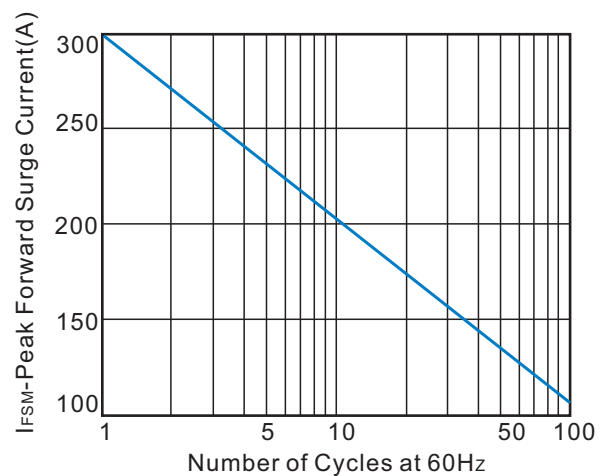

Fig.6 Maximum Non-repetitive Forward Surge



Recommended Soldering Conditions

Recommended Conditions

Reflow Condition		Pb-Free assembly (see Fig.1)
Pre Heat	-Temperature Min($T_{s(min)}$)	+150°C
	-Temperature Max($T_{s(max)}$)	+200°C
	-Time(Min to Max)(t_s)	60-180secs
Average ramp up rate (Liquidus Temp(T_L) to peak)		3°C/sec.Max.
$T_{s(max)}$ to T_L -Ramp-up Rate		3°C/sec.Max.
Reflow	-Temperature(T_L)(Liquidus)	+217°C
	-Temperature(t_L)	60-150secs
Peak Temp(T_P)		+260(+0/-5)°C
Time within 5°C of actual Peak Temp(t_P)		30 secs.Max.
Ramp-down Rate		6°C/sec.Max.
Time 25°C to Peak Temp(T_P)		8 min.Max.
Do not exceed		+260°C

Reflow Soldering

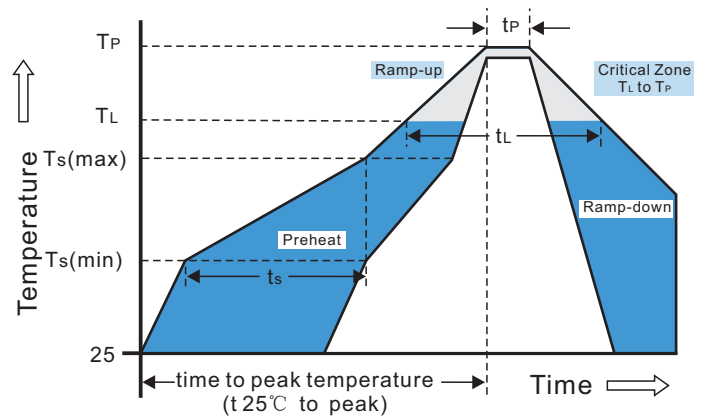

Marking Code

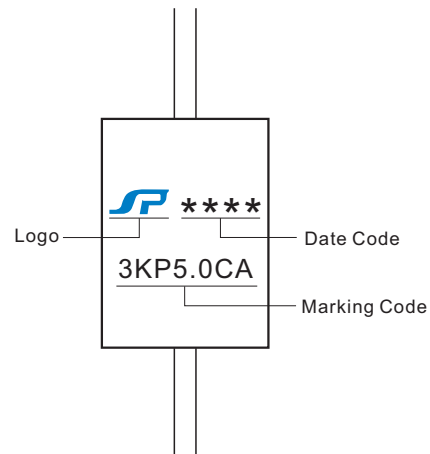
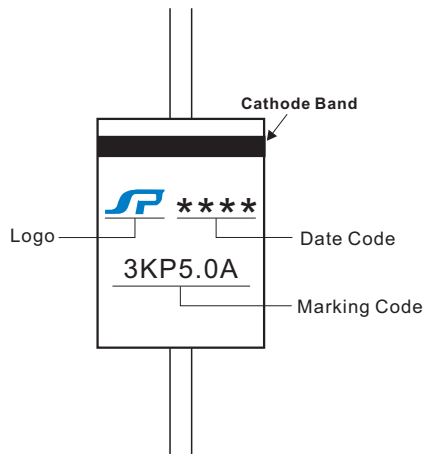

Packaging

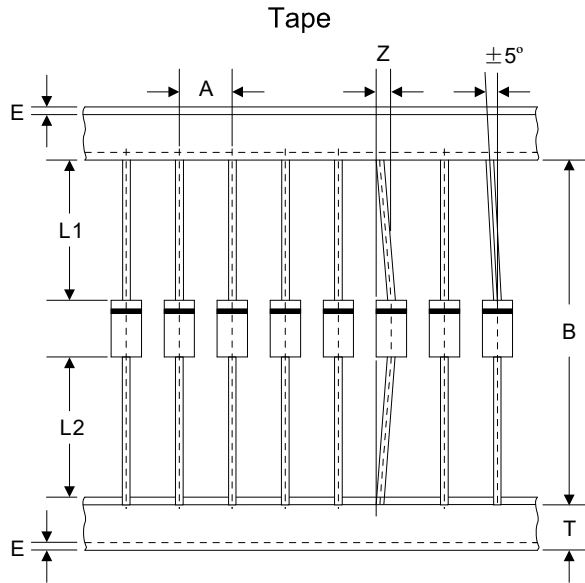

Box

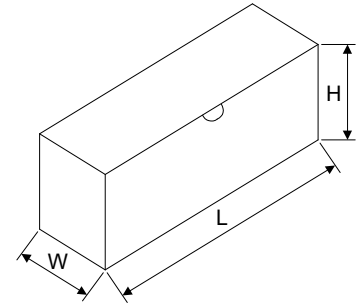

Dimensions in millimeters

A	B	Z	T	E	L1-L2
10.0±0.5	52.0±1.0	1.2Max	6.0±0.4	1.0Max	1.0Max

L	W	H	Quantity
250.0±5.0	78.0±5.0	114.0±5.0	300PCS