

Low Noise, Bipolar Input Dual, Audio Operational amplifier

DESCRIPTION

NJM4585 is a low noise bipolar input dual audio operational amplifier featuring 3.5nV/√Hz at 1 kHz.

The NJM4585 features Low distortion, high slew rate, wide bandwidth and high open-loop gain. In addition, unity-gain stable allows voltage-follower operation. These features make NJM4585 ideal for audio pre amplifier, microphone amplifier, line amplifier and other audio applications. NJM4585 operate over a wide temperature range of -40°C to +125°C, making this IC ideal for use in industrial measurement instruments. The NJM4585 is available in the 8-pin DMP8 packages.

PACKAGE OUTLINE



NJM4585M
(DMP8)

FEATURES

- Designed for High-Quality Sound
- Low Noise (f=1kHz) 3.5nV/√Hz
- Low Distortion 0.001%
- Slew Rate 6.8V/μs
- Gain Bandwidth Product (f=100kHz) 19MHz
- Open-Loop Voltage Gain 120dB
- Unity-Gain stable
- Bipolar Input
- Supply Voltage ±4V to ±18V
- Operating Temperature -40°C to +125°C
- Supply Current (All Amplifiers) 5mA typ.
- Package DMP8

APPLICATIONS

- Professional Audio sets
- Audio pre/microphone amplifiers
- Analog/Digital mixer
- AV Receiver
- Car Audio
- Industrial Measurement Instruments

PIN CONFIGURATION

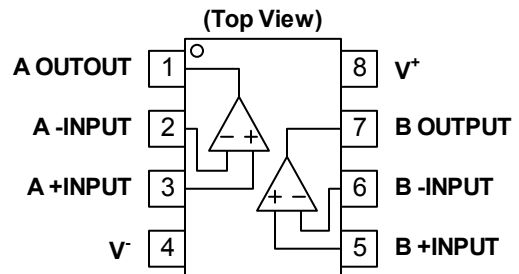

Package	Product Name
DMP8	NJM4585M

EQUIVALENT CIRCUIT

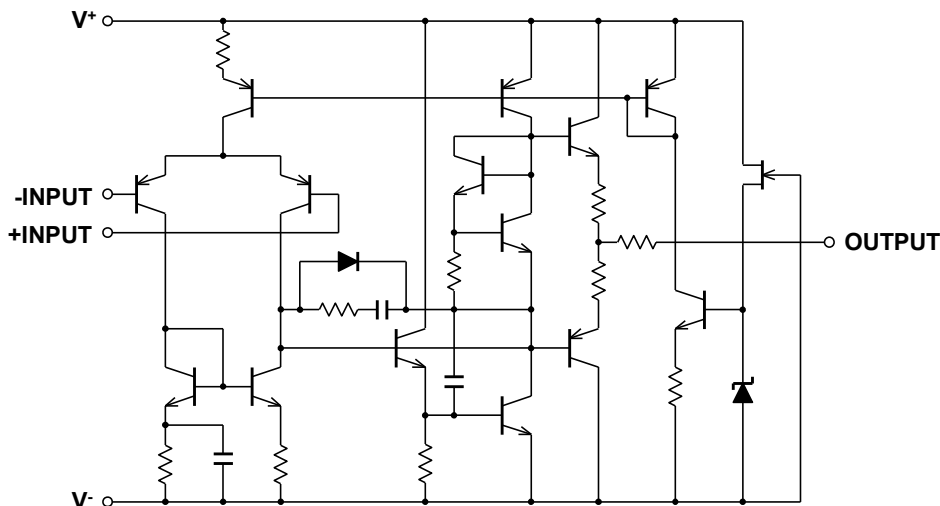

■ ABSOLUTE MAXIMUM RATINGS

PARAMETER	SYMBOL	RATING	UNIT
Supply Voltage	V^+ / V^-	± 18	V
Differential Input Voltage ⁽¹⁾	V_{ID}	± 36	V
Input Voltage ⁽²⁾	V_{IN}	$V^- - 0.3$ to $V^+ + 36$	V
Output Terminal Input Voltage	V_O	$V^- - 0.3$ to $V^+ + 0.3$	V
Power Dissipation ⁽³⁾ DMP8	P_D	(2-layer / 4-layer) 470 / 600	mW
Operating Temperature Range	T_{opr}	-40 to +125	°C
Storage Temperature Range	T_{stg}	-65 to +150	°C

(1) Differential voltage is the voltage difference between +INPUT and -INPUT.

(2) Input voltage is the voltage should be allowed to apply to the input terminal independent of the magnitude of V^+ .
The normal operation will establish when any input is within the Common Mode Input Voltage Range of electrical characteristics.

(3) Power dissipation is the power that can be consumed by the IC at $T_a=25^\circ\text{C}$, and is the typical measured value based on JEDEC condition. When using the IC over $T_a=25^\circ\text{C}$ subtract the value $[\text{mW}/^\circ\text{C}] = P_D / (T_{stg}(\text{MAX}) - 25)$ per temperature.

2-layer: EIA/JEDEC STANDARD Test board (76.2x114.3x1.6mm, 2layers, FR-4) mounting

4-layer: EIA/JEDEC STANDARD Test board (76.2x114.3x1.6mm, 4layers, FR-4) mounting

■ RECOMMENDED OPERATING CONDITIONS ($T_a=25^\circ\text{C}$)

PARAMETER	SYMBOL	TEST CONDITION	MIN.	TYP.	MAX.	UNIT
Supply Voltage	V^+ / V^-		± 4	-	± 18	V

■ ELECTRICAL CHARACTERISTICS ($V^+ / V^- = \pm 15\text{V}$, $T_a=25^\circ\text{C}$, unless otherwise noted.)

PARAMETER	SYMBOL	TEST CONDITION	MIN.	TYP.	MAX.	UNIT
-----------	--------	----------------	------	------	------	------

INPUT/OUTPUT CHARACTERISTICS

Input Offset Voltage	V_{IO}	$R_S \leq 10\text{k}\Omega$	-	0.3	3	mV
Input Bias Current	I_B		-	260	1000	nA
Input Offset Current	I_{IO}		-	5	200	nA
Open Loop Voltage Gain	A_V	$R_L = 2\text{k}\Omega$, $V_O = \pm 10\text{V}$	90	120	-	dB
Common-Mode Rejection Ratio	CMR		80	110	-	dB
Input Resistance	R_{IN}		50	300	-	k Ω
Common-Mode Input Voltage Range	V_{ICM}		± 12	± 13.5	-	V
Maximum Output Voltage	V_{OM}	$R_L \geq 2\text{k}\Omega$	± 12	± 13.5	-	V

POWER SUPPLY

Supply Current(All Amplifiers)	I_Q		-	5	8	mA
Supply Voltage Rejection Ratio	SVR		80	120	-	dB

AC PERFORMANCE

Gain Bandwidth Product	GBW	$f=100\text{kHz}$	-	19	-	MHz
Unity Gain Frequency	f_T	$G_v=0\text{dB}$	-	7.5	-	MHz
Slew Rate	SR	$R_L \geq 2\text{k}\Omega$	-	6.8	-	V/ μs

NOISE, DISTORTION

Equivalent Input Noise Voltage	e_n	$f=1\text{kHz}$	-	3.5	-	nV/ $\sqrt{\text{Hz}}$
		FLAT, $f=20\text{Hz} \sim 20\text{kHz}$	-	0.5	0.7	μVrms
Total Harmonic Distortion	THD		-	0.001	-	%
Channel Separation	CS		-	120	-	dB

■ TYPICAL CHARACTERISTICS

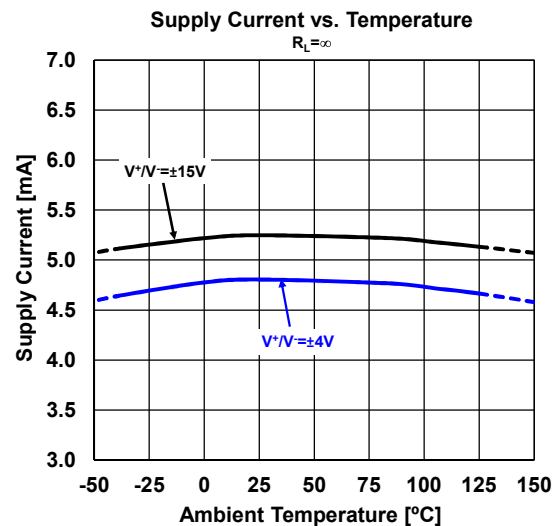
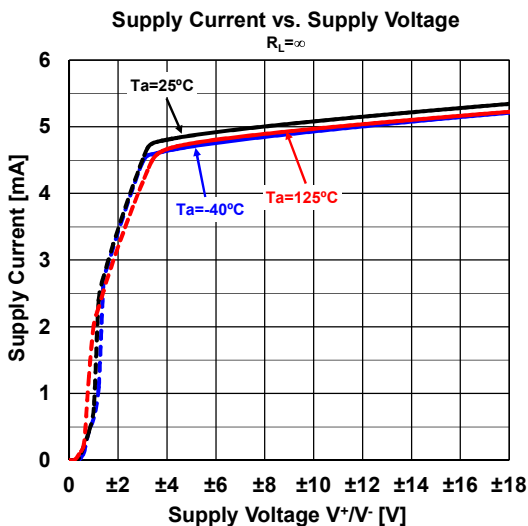
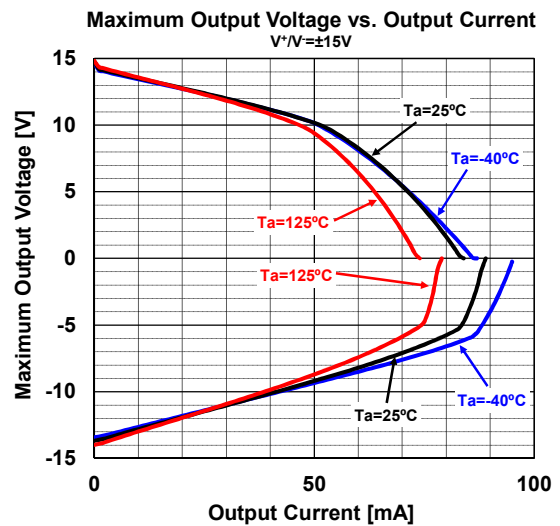
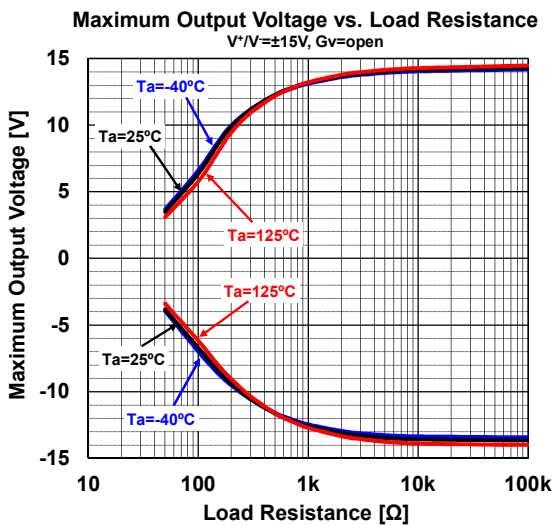
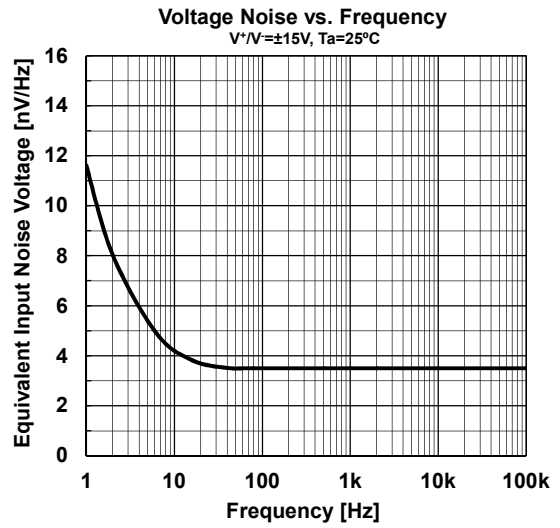
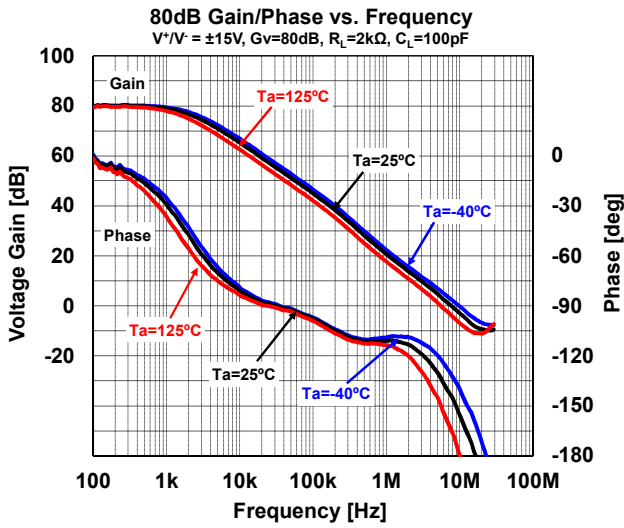

■ TYPICAL CHARACTERISTICS

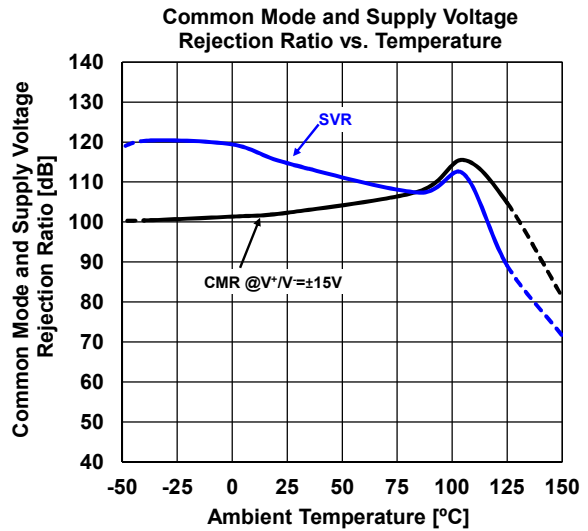
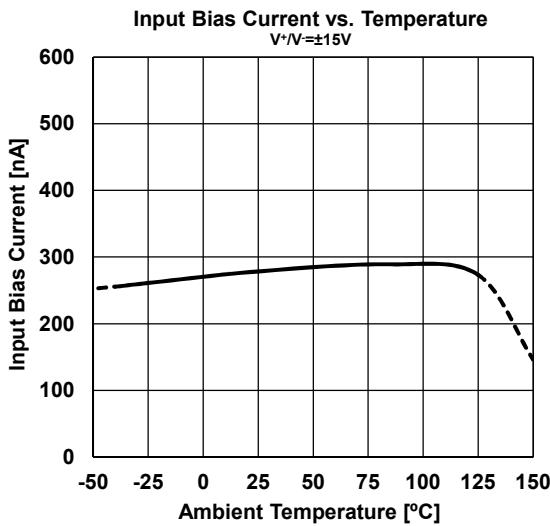
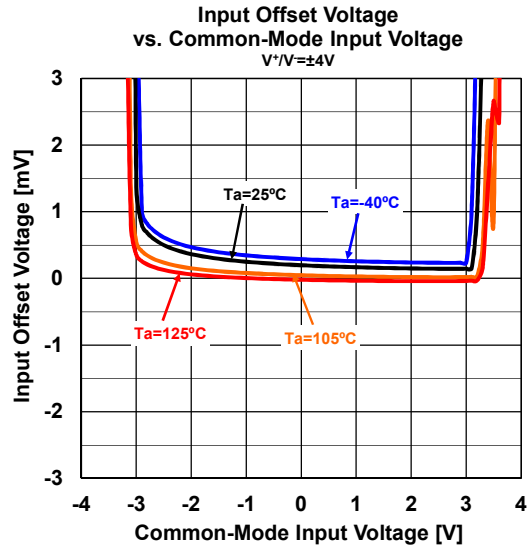
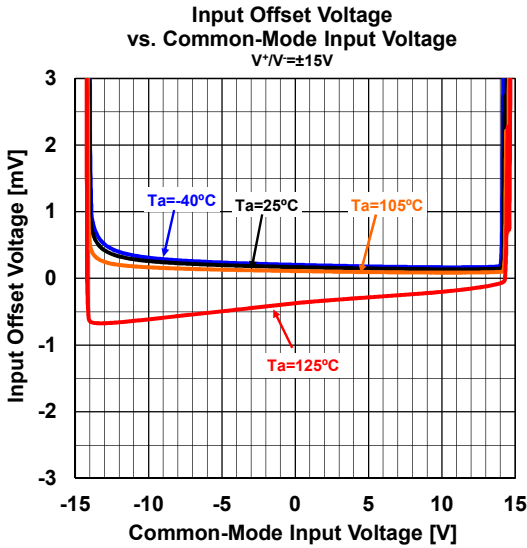
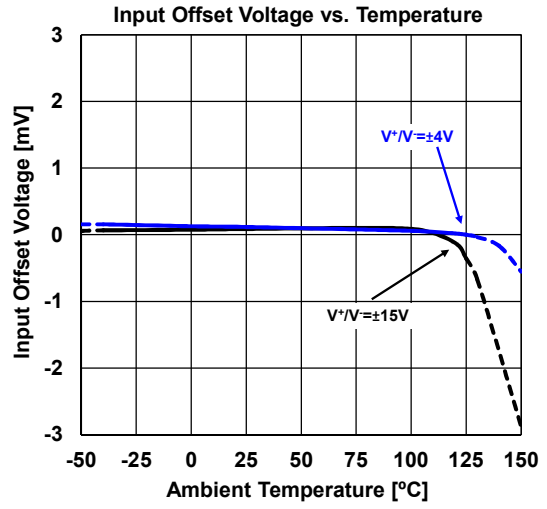
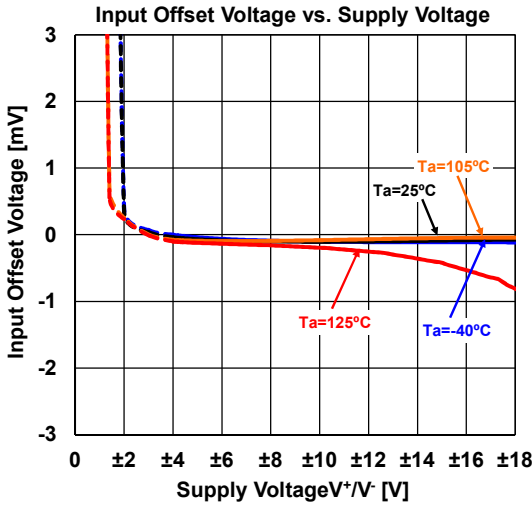

■ TYPICAL CHARACTERISTICS

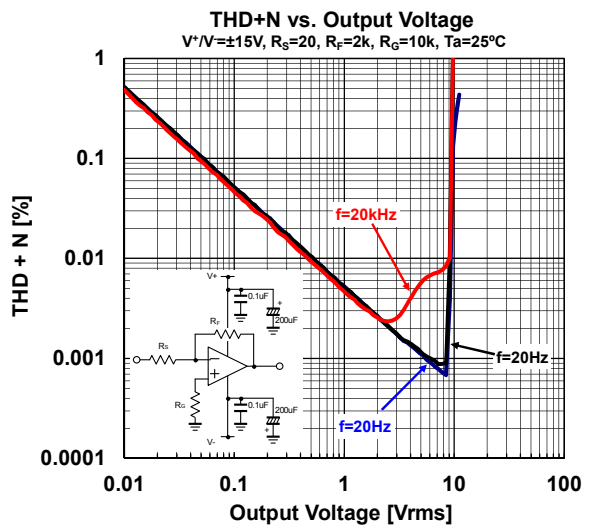
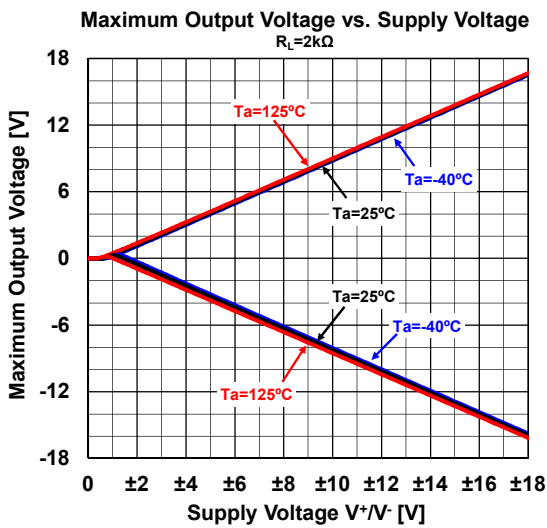
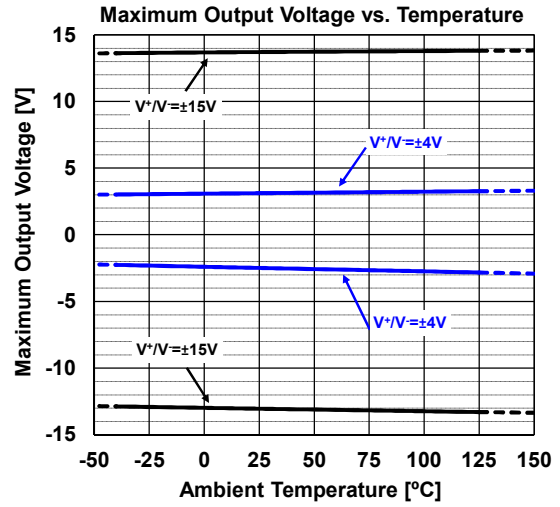
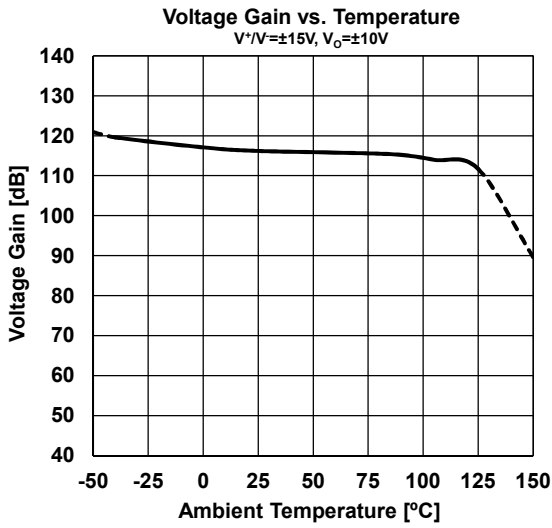

■PACKAGE DIMENSIONS

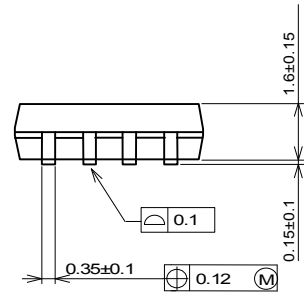
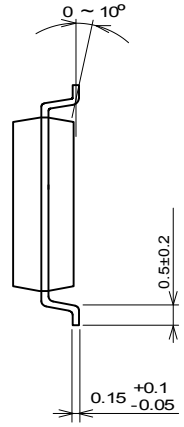
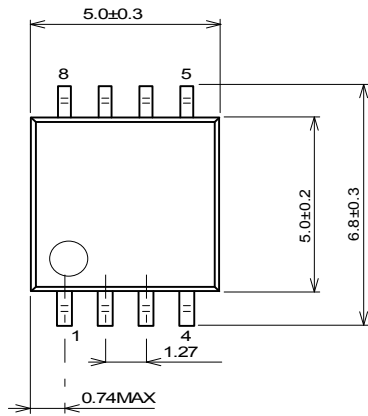

Unit: mm

DMP8 Package

[CAUTION]
 The specifications on this databook are only given for information, without any guarantee as regards either mistakes or omissions. The application circuits in this databook are described only to show representative usages of the product and not intended for the guarantee or permission of any right including the industrial rights.