

**4N25  
4N37**

**4N26  
H11A1**

**4N27  
H11A2**

**4N28  
H11A3**

**4N35  
H11A4**

**4N36  
H11A5**

**WHITE PACKAGE (-M SUFFIX)**

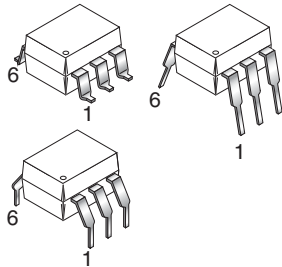

**SCHEMATIC**

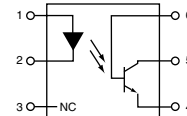

PIN 1. ANODE  
2. CATHODE  
3. NO CONNECTION  
4. EMITTER  
5. COLLECTOR  
6. BASE

**BLACK PACKAGE (NO -M SUFFIX)**

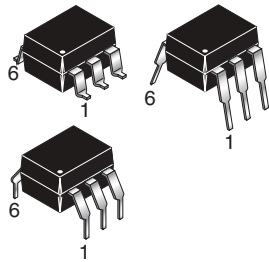

**DESCRIPTION**

The general purpose optocouplers consist of a gallium arsenide infrared emitting diode driving a silicon phototransistor in a 6-pin dual in-line package.

**FEATURES**

- Also available in white package by specifying -M suffix, eg. 4N25-M
- UL recognized (File # E90700)
- VDE recognized (File # 94766)
  - Add option V for white package (e.g., 4N25V-M)
  - Add option 300 for black package (e.g., 4N25.300)

**APPLICATIONS**

- Power supply regulators
- Digital logic inputs
- Microprocessor inputs

**4N25  
4N37**

**4N26  
H11A1**

**4N27  
H11A2**

**4N28  
H11A3**

**4N35  
H11A4**

**4N36  
H11A5**

**ABSOLUTE MAXIMUM RATINGS** ( $T_A = 25^\circ\text{C}$  unless otherwise specified)

Parameter	Symbol	Value	Units
<b>TOTAL DEVICE</b>			
Storage Temperature	$T_{STG}$	-55 to +150	$^\circ\text{C}$
Operating Temperature	$T_{OPR}$	-55 to +100	$^\circ\text{C}$
Wave solder temperature (see page 14 for reflow solder profiles)	$T_{SOL}$	260 for 10 sec	$^\circ\text{C}$
Total Device Power Dissipation @ $T_A = 25^\circ\text{C}$ Derate above $25^\circ\text{C}$	$P_D$	250 3.3 (non-M), 2.94 (-M)	mW
<b>EMITTER</b>			
DC/Average Forward Input Current	$I_F$	100 (non-M), 60 (-M)	mA
Reverse Input Voltage	$V_R$	6	V
Forward Current - Peak (300 $\mu\text{s}$ , 2% Duty Cycle)	$I_{F(pk)}$	3	A
LED Power Dissipation @ $T_A = 25^\circ\text{C}$ Derate above $25^\circ\text{C}$	$P_D$	150 (non-M), 120 (-M) 2.0 (non-M), 1.41 (-M)	mW mW/ $^\circ\text{C}$
<b>DETECTOR</b>			
Collector-Emitter Voltage	$V_{CEO}$	30	V
Collector-Base Voltage	$V_{CBO}$	70	V
Emitter-Collector Voltage	$V_{ECO}$	7	V
Detector Power Dissipation @ $T_A = 25^\circ\text{C}$ Derate above $25^\circ\text{C}$	$P_D$	150 2.0 (non-M), 1.76 (-M)	mW mW/ $^\circ\text{C}$

**4N25  
4N37**

**4N26  
H11A1**

**4N27  
H11A2**

**4N28  
H11A3**

**4N35  
H11A4**

**4N36  
H11A5**

**ELECTRICAL CHARACTERISTICS** ( $T_A = 25^\circ\text{C}$  unless otherwise specified)

**INDIVIDUAL COMPONENT CHARACTERISTICS**

Parameter	Test Conditions	Symbol	Min	Typ*	Max	Unit
<b>EMITTER</b>						
Input Forward Voltage	( $I_F = 10 \text{ mA}$ )	$V_F$		1.18	1.50	V
Reverse Leakage Current	( $V_R = 6.0 \text{ V}$ )	$I_R$		0.001	10	$\mu\text{A}$
<b>DETECTOR</b>						
Collector-Emitter Breakdown Voltage	( $I_C = 1.0 \text{ mA}, I_F = 0$ )	$BV_{CEO}$	30	100		V
Collector-Base Breakdown Voltage	( $I_C = 100 \mu\text{A}, I_F = 0$ )	$BV_{CBO}$	70	120		V
Emitter-Collector Breakdown Voltage	( $I_E = 100 \mu\text{A}, I_F = 0$ )	$BV_{ECO}$	7	10		V
Collector-Emitter Dark Current	( $V_{CE} = 10 \text{ V}, I_F = 0$ )	$I_{CEO}$		1	50	nA
Collector-Base Dark Current	( $V_{CB} = 10 \text{ V}$ )	$I_{CBO}$			20	nA
Capacitance	( $V_{CE} = 0 \text{ V}, f = 1 \text{ MHz}$ )	$C_{CE}$		8		pF

**ISOLATION CHARACTERISTICS**

Characteristic	Test Conditions	Symbol	Min	Typ*	Max	Units
Input-Output Isolation Voltage	(Non '-M', Black Package) ( $f = 60 \text{ Hz}, t = 1 \text{ min}$ )	$V_{ISO}$	5300			Vac(rms)
	('M', White Package) ( $f = 60 \text{ Hz}, t = 1 \text{ sec}$ )		7500			Vac(pk)
Isolation Resistance	( $V_{I-O} = 500 \text{ VDC}$ )	$R_{ISO}$	$10^{11}$			$\Omega$
Isolation Capacitance	( $V_{I-O} = \&, f = 1 \text{ MHz}$ )	$C_{ISO}$		0.5		pF
	('M' White Package)			0.2	2	pF

Note

\* Typical values at  $T_A = 25^\circ\text{C}$

**4N25  
4N37**

**4N26  
H11A1**

**4N27  
H11A2**

**4N28  
H11A3**

**4N35  
H11A4**

**4N36  
H11A5**

**TRANSFER CHARACTERISTICS** ( $T_A = 25^\circ\text{C}$  Unless otherwise specified.)

DC Characteristic	Test Conditions	Symbol	Device	Min	Typ*	Max	Unit
Current Transfer Ratio, Collector to Emitter	$(I_F = 10 \text{ mA}, V_{CE} = 10 \text{ V})$	CTR	4N35 4N36 4N37	100			%
			H11A1	50			
			H11A5	30			
	4N25 4N26 H11A2 H11A3		20				
	4N27 4N28 H11A4		10				
	4N35 4N36 4N37		40				
	$(I_F = 10 \text{ mA}, V_{CE} = 10 \text{ V}, T_A = -55^\circ\text{C})$		40				
	$(I_F = 10 \text{ mA}, V_{CE} = 10 \text{ V}, T_A = +100^\circ\text{C})$		40				
Collector-Emitter Saturation Voltage	$(I_C = 2 \text{ mA}, I_F = 50 \text{ mA})$	$V_{CE(SAT)}$	4N25 4N26 4N27 4N28			0.5	V
	$(I_C = 0.5 \text{ mA}, I_F = 10 \text{ mA})$		4N35 4N36 4N37			0.3	
			H11A1 H11A2 H11A3 H11A4 H11A5			0.4	
AC Characteristic							
Non-Saturated Turn-on Time	$(I_F = 10 \text{ mA}, V_{CC} = 10 \text{ V}, R_L = 100\Omega)$ (Fig.20)	$T_{ON}$	4N25 4N26 4N27 4N28 H11A1 H11A2 H11A3 H11A4 H11A5		2		$\mu\text{s}$
Non Saturated Turn-on Time	$(I_C = 2 \text{ mA}, V_{CC} = 10 \text{ V}, R_L = 100\Omega)$ (Fig.20)	$T_{ON}$	4N35 4N36 4N37		2	10	$\mu\text{s}$

**4N25  
4N37**

**4N26  
H11A1**

**4N27  
H11A2**

**4N28  
H11A3**

**4N35  
H11A4**

**4N36  
H11A5**

**TRANSFER CHARACTERISTICS** ( $T_A = 25^\circ\text{C}$  Unless otherwise specified.) (Continued)

AC Characteristic	Test Conditions	Symbol	Device	Min	Typ*	Max	Unit
Turn-off Time	( $I_F = 10 \text{ mA}$ , $V_{CC} = 10 \text{ V}$ , $R_L = 100\Omega$ ) (Fig.20)	$T_{OFF}$	4N25 4N26 4N27 4N28 H11A1 H11A2 H11A3 H11A4 H11A5		2		$\mu\text{s}$
	( $I_C = 2 \text{ mA}$ , $V_{CC} = 10 \text{ V}$ , $R_L = 100\Omega$ ) (Fig.20)		4N35 4N36 4N37		2	10	

\* Typical values at  $T_A = 25^\circ\text{C}$

**4N25  
4N37**

**4N26  
H11A1**

**4N27  
H11A2**

**4N28  
H11A3**

**4N35  
H11A4**

**4N36  
H11A5**

**TYPICAL PERFORMANCE CURVES**

**Fig. 1 LED Forward Voltage vs. Forward Current  
(Black Package)**

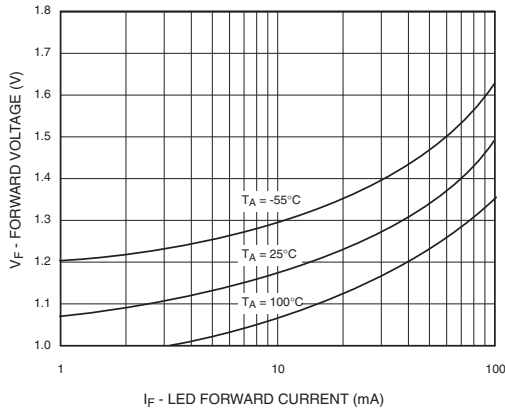

**Fig. 2 LED Forward Voltage vs. Forward Current  
(White Package)**

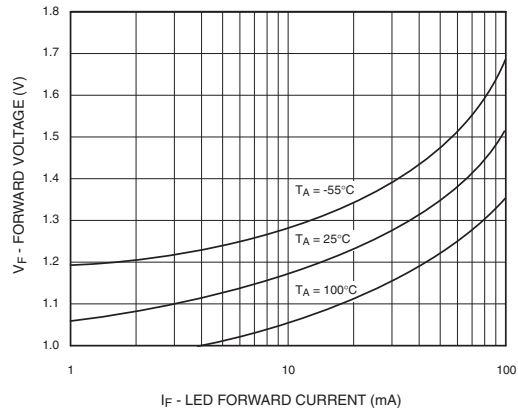

**Fig.3 Normalized CTR vs. Forward Current  
(Black Package)**

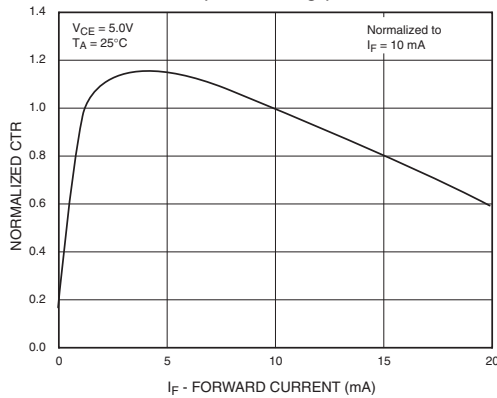

**Fig.4 Normalized CTR vs. Forward Current  
(White Package)**

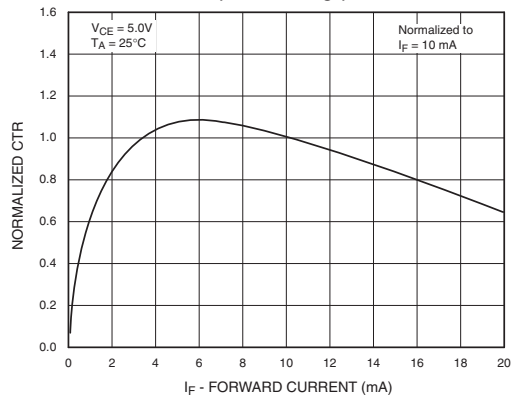

**Fig. 5 Normalized CTR vs. Ambient Temperature  
(Black Package)**

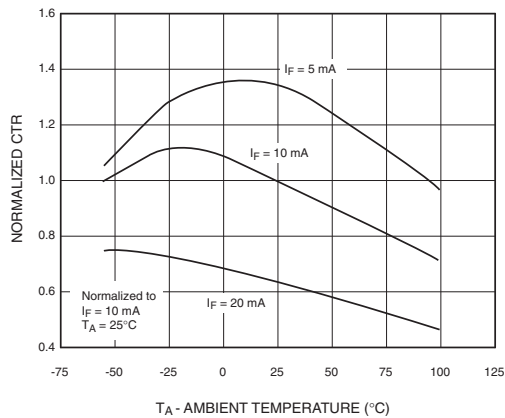

**Fig. 6 Normalized CTR vs. Ambient Temperature  
(White Package)**

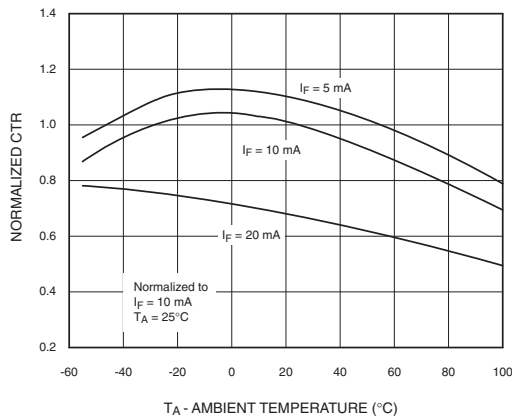

**4N25  
4N37**

**4N26  
H11A1**

**4N27  
H11A2**

**4N28  
H11A3**

**4N35  
H11A4**

**4N36  
H11A5**

**Fig. 7 CTR vs. RBE (Unsaturated)  
(Black Package)**

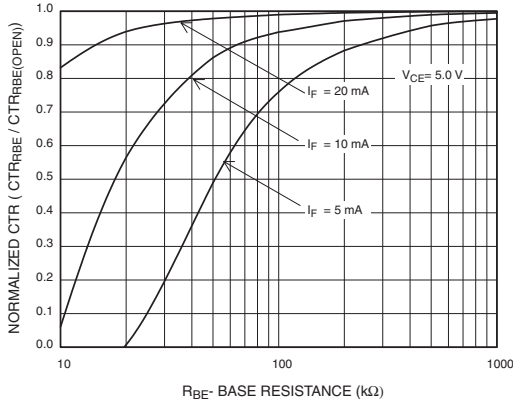

**Fig. 8 CTR vs. RBE (Unsaturated)  
(White Package)**

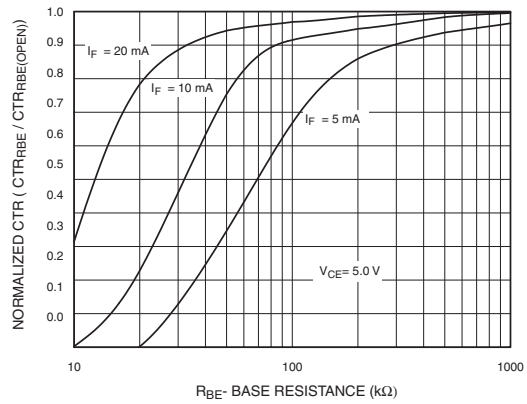

**Fig. 9 CTR vs. RBE (Saturated)  
(Black Package)**

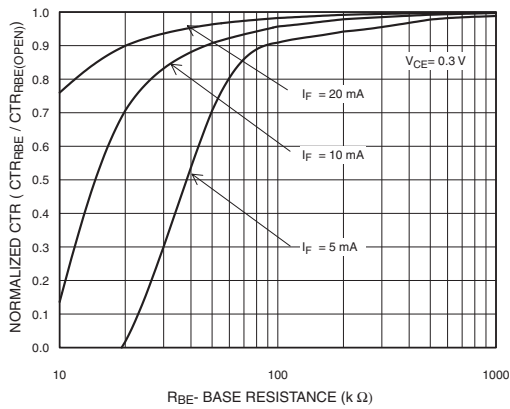

**Fig. 10 CTR vs. RBE (Saturated)  
(White Package)**

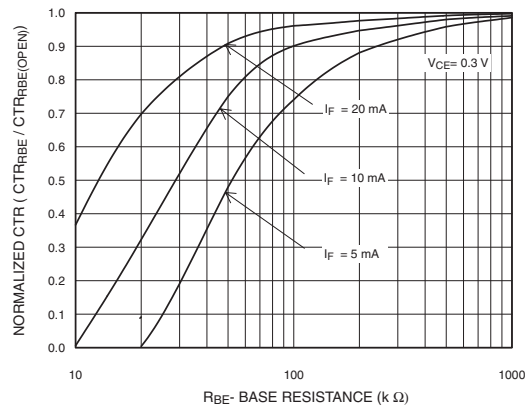

**Fig. 11 Collector-Emitter Saturation Voltage vs. Collector Current  
(Black Package)**

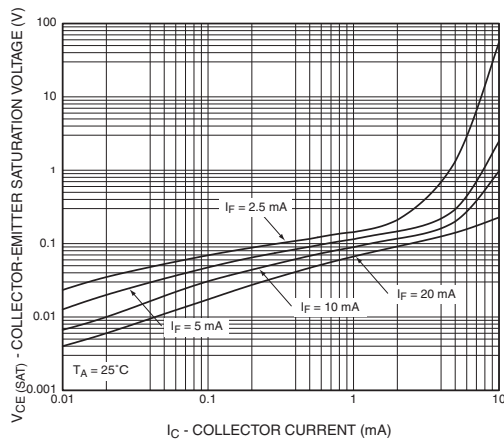

**Fig. 12 Collector-Emitter Saturation Voltage vs. Collector Current  
(White Package)**

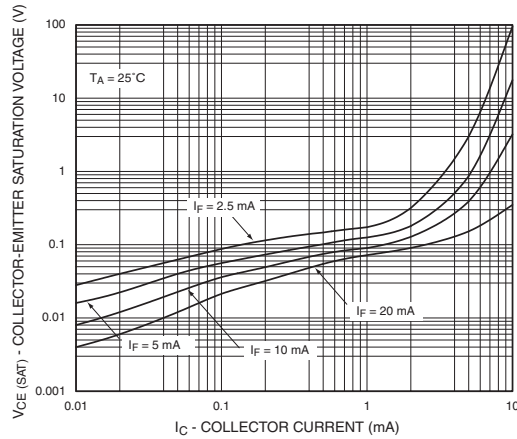

**4N25  
4N37**

**4N26  
H11A1**

**4N27  
H11A2**

**4N28  
H11A3**

**4N35  
H11A4**

**4N36  
H11A5**

**Fig. 13 Switching Speed vs. Load Resistor  
(Black Package)**

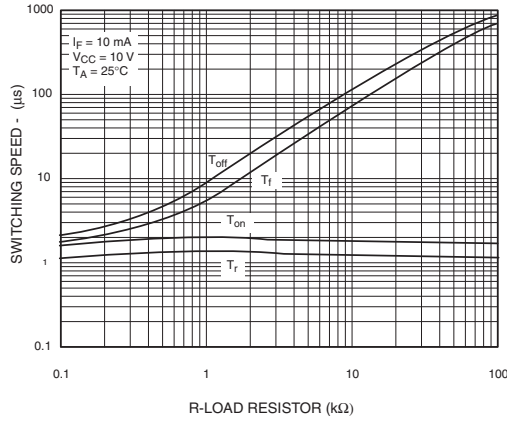

**Fig. 14 Switching Speed vs. Load Resistor  
(White Package)**

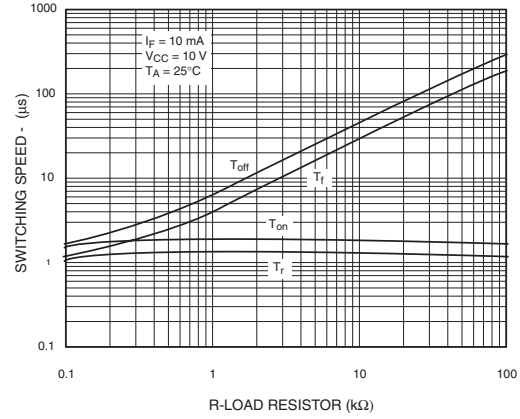

**Fig. 15 Normalized  $t_{on}$  vs.  $R_{BE}$   
(Black Package)**

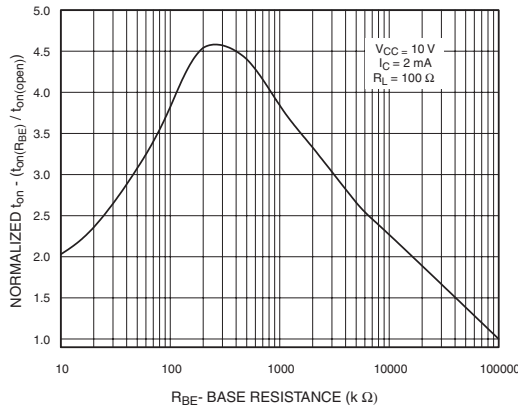

**Fig. 16 Normalized  $t_{on}$  vs.  $R_{BE}$   
(White Package)**

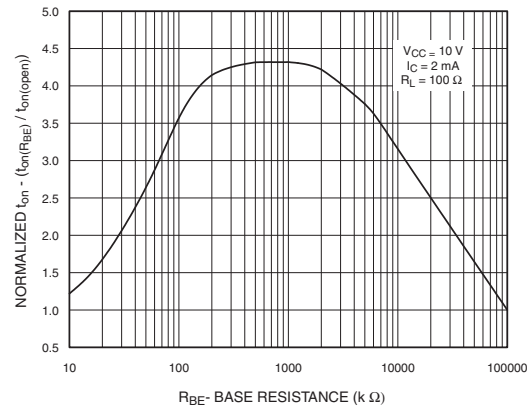

**Fig. 17 Normalized  $t_{off}$  vs.  $R_{BE}$   
(Black Package)**

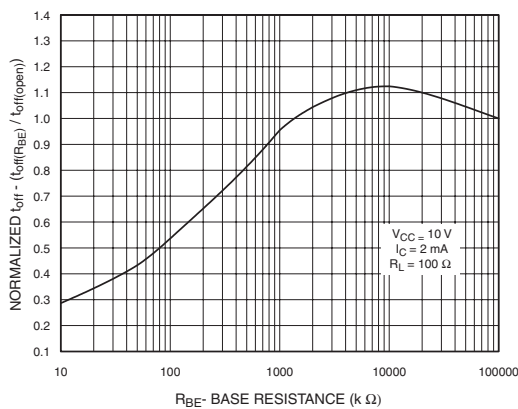

**Fig. 18 Normalized  $t_{off}$  vs.  $R_{BE}$   
(White Package)**

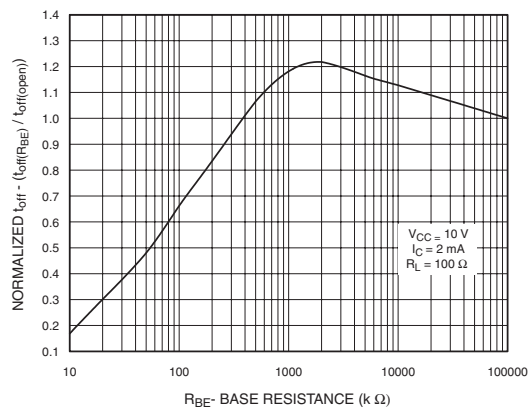



4N25  
4N37

4N26  
H11A1

4N27  
H11A2

4N28  
H11A3

4N35  
H11A4

4N36  
H11A5

Fig. 19 Dark Current vs. Ambient Temperature

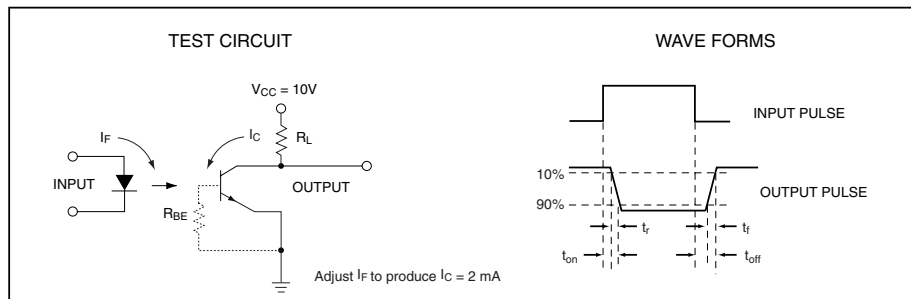
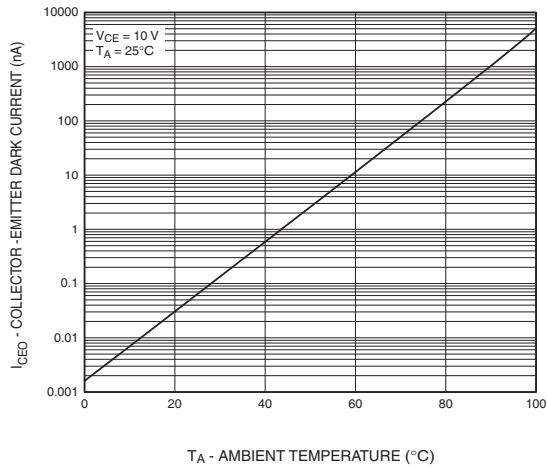

Figure 20. Switching Time Test Circuit and Waveforms



**4N25  
4N37**

**4N26  
H11A1**

**4N27  
H11A2**

**4N28  
H11A3**

**4N35  
H11A4**

**4N36  
H11A5**

**White Package (-M Suffix)**

**Package Dimensions (Through Hole)**

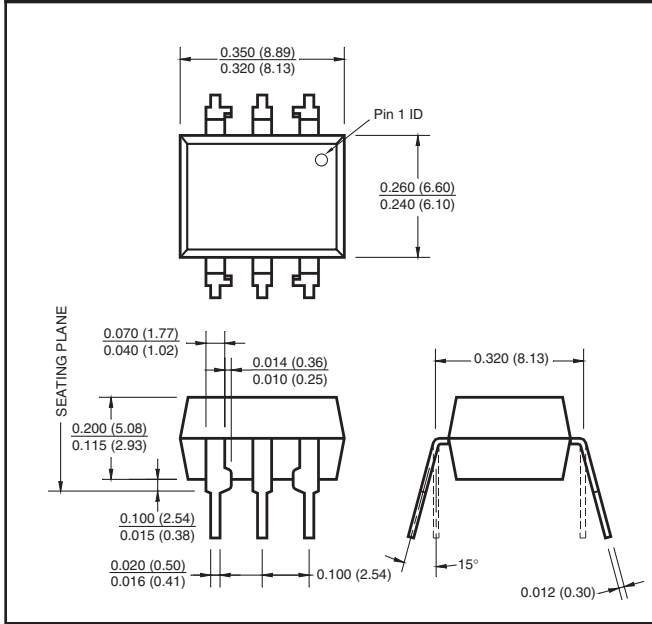

**Package Dimensions (Surface Mount)**

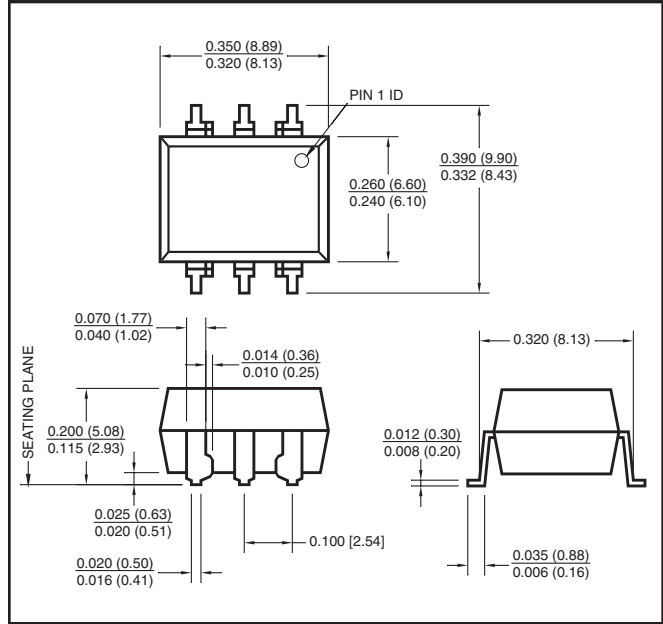

**Package Dimensions (0.4" Lead Spacing)**

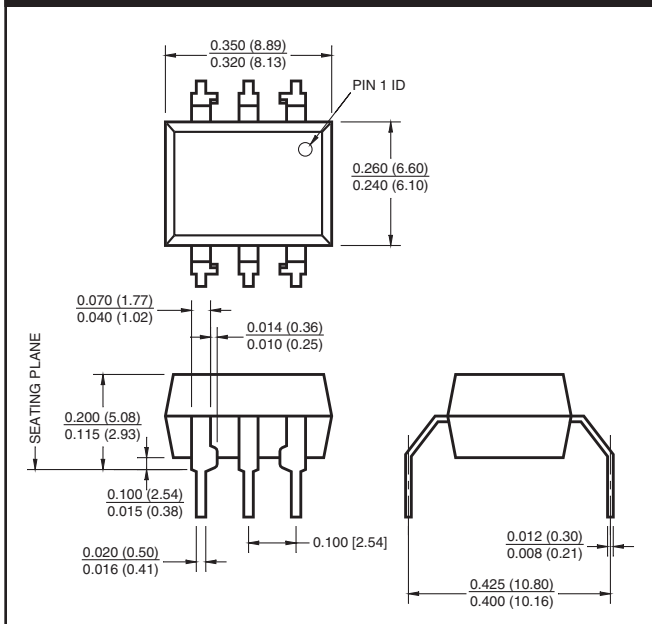

**Recommended Pad Layout for  
Surface Mount Leadform**

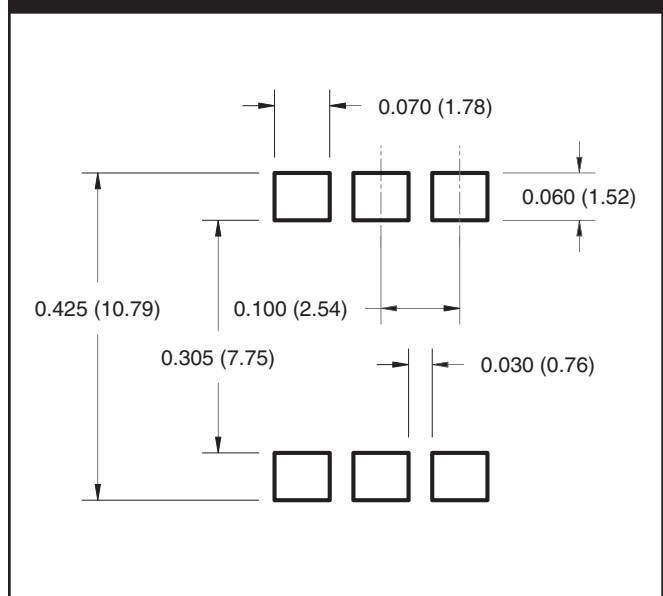

**NOTE**

All dimensions are in inches (millimeters)

**4N25  
4N37**

**4N26  
H11A1**

**4N27  
H11A2**

**4N28  
H11A3**

**4N35  
H11A4**

**4N36  
H11A5**

**ORDERING INFORMATION**

Order Entry Identifier		
Black Package (No Suffix)	White Package (-M Suffix)	Option
.S	S	Surface Mount Lead Bend
.SD	SR2	Surface Mount; Tape and reel
.W	T	0.4" Lead Spacing
.300	V	VDE 0884
.300W	TV	VDE 0884, 0.4" Lead Spacing
.3S	SV	VDE 0884, Surface Mount
.3SD	SR2V	VDE 0884, Surface Mount, Tape & Reel

**MARKING INFORMATION**

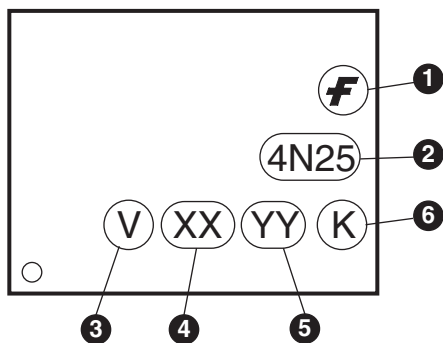

**Black Package, No Suffix**

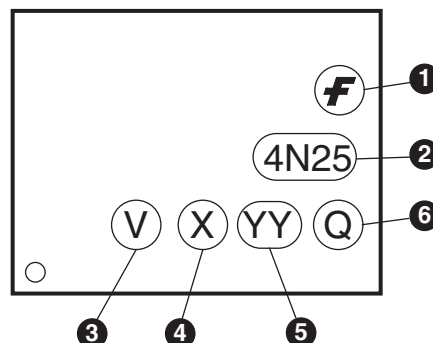

**White Package, -M Suffix**

Definitions	
1	Fairchild logo
2	Device number
3	VDE mark (Note: Only appears on parts ordered with VDE option – See order entry table)
4	One or two digit year code • Two digits for black package parts, e.g., '03' • One digit for white package parts, e.g., '3'
5	Two digit work week ranging from '01' to '53'
6	Assembly package code

\*Note – Parts built in the white package (M suffix) that do not have the 'V' option (see definition 3 above) that are marked with date code '325' or earlier are marked in the portrait format.



**4N25  
4N37**

**4N26  
H11A1**

**4N27  
H11A2**

**4N28  
H11A3**

**4N35  
H11A4**

**4N36  
H11A5**

**Reflow Profile (White Package, -M Suffix)**

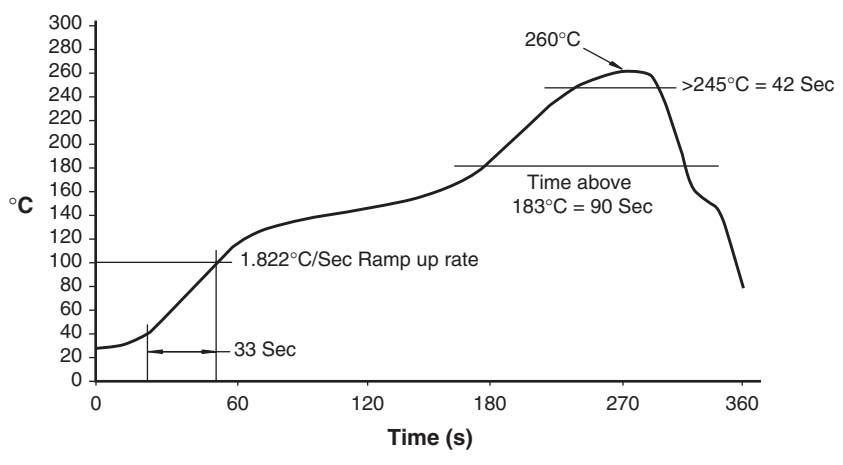

**Reflow Profile (Black Package, No Suffix)**

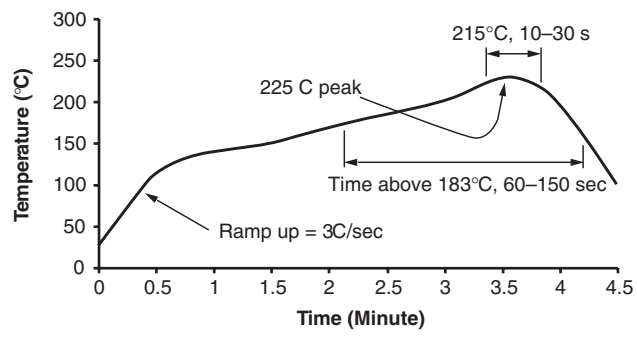

- Peak reflow temperature: 225°C (package surface temperature)
- Time of temperature higher than 183°C for 60-150 seconds
- One time soldering reflow is recommended

---

**4N25  
4N37**

**4N26  
H11A1**

**4N27  
H11A2**

**4N28  
H11A3**

**4N35  
H11A4**

**4N36  
H11A5**

---

**DISCLAIMER**

FAIRCHILD SEMICONDUCTOR RESERVES THE RIGHT TO MAKE CHANGES WITHOUT FURTHER NOTICE TO ANY PRODUCTS HEREIN TO IMPROVE RELIABILITY, FUNCTION OR DESIGN. FAIRCHILD DOES NOT ASSUME ANY LIABILITY ARISING OUT OF THE APPLICATION OR USE OF ANY PRODUCT OR CIRCUIT DESCRIBED HEREIN; NEITHER DOES IT CONVEY ANY LICENSE UNDER ITS PATENT RIGHTS, NOR THE RIGHTS OF OTHERS.

**LIFE SUPPORT POLICY**

FAIRCHILD'S PRODUCTS ARE NOT AUTHORIZED FOR USE AS CRITICAL COMPONENTS IN LIFE SUPPORT DEVICES OR SYSTEMS WITHOUT THE EXPRESS WRITTEN APPROVAL OF THE PRESIDENT OF FAIRCHILD SEMICONDUCTOR CORPORATION. As used herein:

1. Life support devices or systems are devices or systems which, (a) are intended for surgical implant into the body, or (b) support or sustain life, and (c) whose failure to perform when properly used in accordance with instructions for use provided in the labeling, can be reasonably expected to result in a significant injury of the user.
2. A critical component in any component of a life support device or system whose failure to perform can be reasonably expected to cause the failure of the life support device or system, or to affect its safety or effectiveness.