



# HIGH CURRENT, SUPER LOW DROPOUT ADJUSTABLE VOLTAGE REGULATOR 5012

M.S.KENNEDY CORP.

4707 Dey Road Liverpool, N.Y. 13088

(315) 701-6751

**FEATURES:**

- Extremely Low Dropout Voltage 0.45V @ 10 Amps
- Output Voltage Adjustable from +1.30V to +36V
- Low External Component Count
- Electrically Isolated Case
- Low Quiescent Current
- Output Current to 10 Amps
- Available in Two Package Styles
- Available with Three Lead Form Options
- Contact MSK for MIL-PRF-38534 Qualification Status

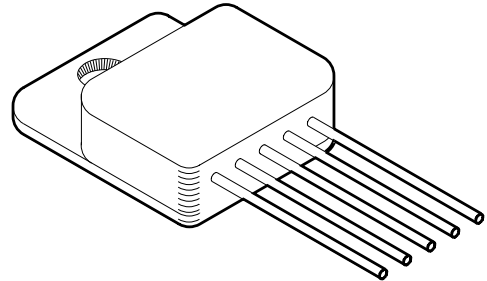

**DESCRIPTION:**

The MSK 5012 voltage regulator output is fully programmable through the use of two external resistors. Ultra low dropout voltage specifications are realized due to the unique output configuration which uses an extremely low  $R_{ds(on)}$  MOSFET as a pass element. Dropout voltages of 0.45V at ten amps are typical in this configuration which drives efficiency up and power dissipation down. Accuracy is guaranteed with a  $\pm 1\%$  initial output voltage tolerance that only varies  $\pm 2\%$  with temperature. The MSK 5012 is packaged in a space efficient 5 pin SIP package that is electrically isolated from the internal circuitry allowing direct heat sinking for efficient thermal dissipation.

**EQUIVALENT SCHEMATIC**

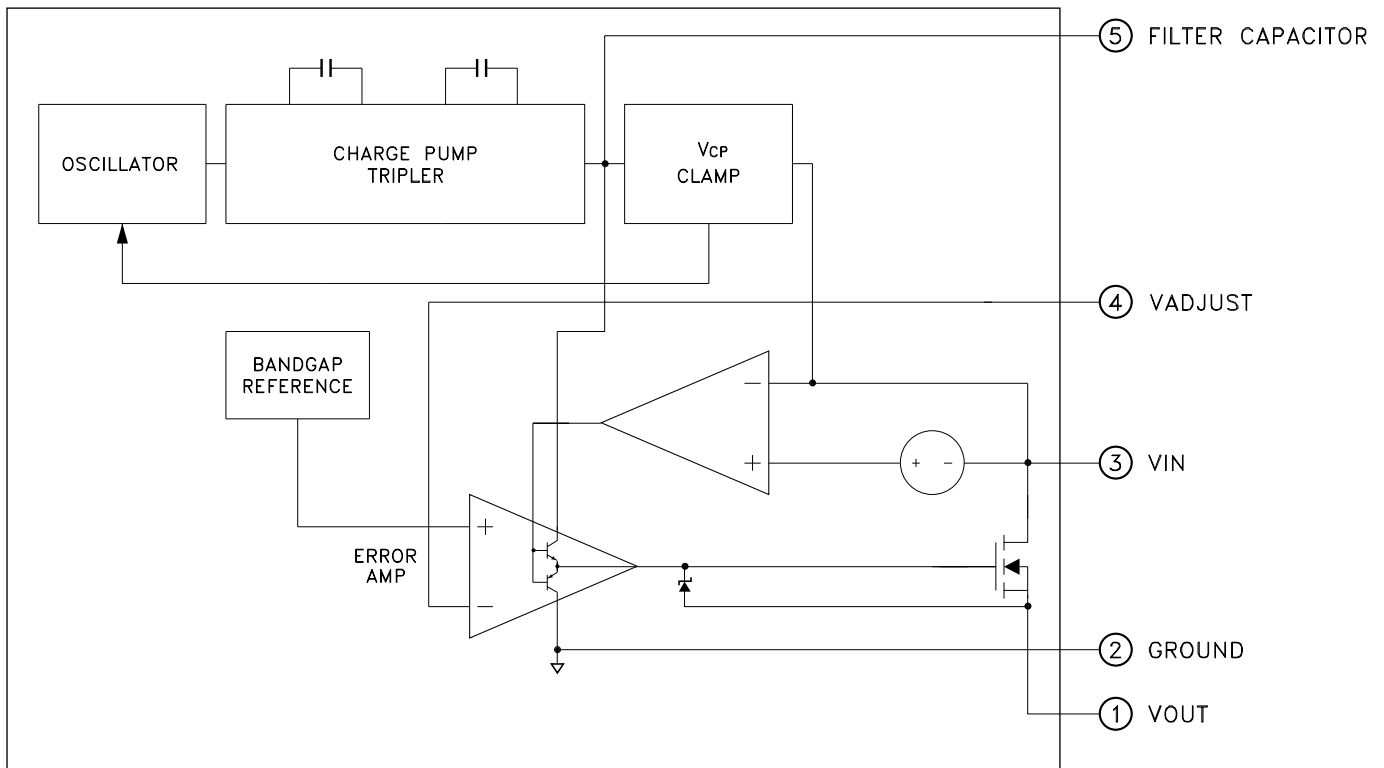

**TYPICAL APPLICATIONS**

- High Efficiency, High Current Linear Regulators
- System Power Supplies
- Constant Voltage/Current Regulators
- Switching Power Supply Post Regulators

## ABSOLUTE MAXIMUM RATINGS <sup>⑧</sup>

V<sub>IN</sub> Input Voltage . . . . . 36V  
 I<sub>OUT</sub> Output Current . . . . . 10A within SOA  
 T<sub>J</sub> Junction Temperature. . . . . +175°C

T<sub>ST</sub> Storage Temperature Range -65°C to +150°C  
 T<sub>LD</sub> Lead Temperature Range. . . . . 300°C  
 (10 Seconds)  
 T<sub>C</sub> Case Operating Temperature  
 MSK5012 . . . . . -40°C to +85°C  
 MSK5012B/E . . . . . -55°C to +125°C

## ELECTRICAL SPECIFICATIONS

Parameter	Test Conditions <sup>③</sup>	Group A Subgroup	MSK 5012B/E			MSK 5012			Units
			Min.	Typ.	Max.	Min.	Typ.	Max.	
Output Voltage Range	R2 = 10KΩ	-	1.3	-	36	1.3	-	36	V
Output Voltage Tolerance <sup>⑦</sup>	I <sub>OUT</sub> = 100mA; V <sub>IN</sub> = V <sub>OUT</sub> + 3V	1	-	±0.3	±1.0	-	±0.3	±1.5	%
		2,3	-	±1.0	±2.0	-	-	-	%
Input Voltage Range <sup>②</sup>		-	3	-	36	3	-	36	V
Dropout Voltage <sup>②</sup>	I <sub>OUT</sub> = 0A	1	-	0.002	0.010	-	0.002	0.010	V
Dropout Voltage <sup>②</sup>	I <sub>OUT</sub> = 10A	1	-	0.4	0.75	-	0.5	1.0	V
Load Regulation	V <sub>IN</sub> = V <sub>OUT</sub> + 3V 100mA ≤ I <sub>OUT</sub> ≤ 9A	1	-	±0.5	±1.0	-	±0.5	±1.5	%
		2,3	-	±0.5	±2.0	-	-	-	%
Line Regulation	(V <sub>OUT</sub> + 1.5) ≤ V <sub>IN</sub> ≤ (V <sub>OUT</sub> + 15), I <sub>OUT</sub> = 100mA	1	-	±0.3	±1.0	-	±0.3	±1.5	%
		2,3	-	-	±1.0	-	-	-	%
Quiescent Current	V <sub>IN</sub> = V <sub>OUT</sub> + 3V; I <sub>OUT</sub> = 0A	1	-	4.5	10	-	4.5	12	mA
		2,3	-	-	10	-	-	-	mA
Ripple Rejection <sup>②</sup>	f = 120Hz	-	-	45	-	-	45	-	dB
Thermal Resistance <sup>②</sup>	Junction to Case @ 125°C	-	-	0.7	0.8	-	0.7	0.8	°C/W
Output Settling Time <sup>②</sup>	T <sub>o</sub> within 10mV (I <sub>OUT</sub> = 0A)	-	-	5	-	-	5	-	μS
V <sub>Adjust</sub> Voltage	V <sub>IN</sub> = V <sub>OUT</sub> + 3V	1	1.222	1.235	1.248	1.21	1.24	1.26	V

### NOTES:

- ① Output decoupled to ground using 47μF minimum capacitor and R1 = 30KΩ; R2 = 10KΩ unless otherwise specified.
- ② This parameter is guaranteed by design but need not be tested. Typical parameters are representative of actual device performance at 25°C but are for reference only.
- ③ All output parameters are tested using a low duty cycle pulse to maintain T<sub>J</sub> = T<sub>C</sub>.
- ④ Industrial grade and "E" suffix devices shall be tested to subgroup 1 unless otherwise specified.
- ⑤ Military grade devices ('B' suffix) shall be 100% tested to subgroups 1,2 and 3.
- ⑥ Subgroup 1    T<sub>A</sub> = T<sub>C</sub> = +25°C  
 Subgroup 2    T<sub>A</sub> = T<sub>C</sub> = +125°C  
 Subgroup 3    T<sub>A</sub> = T<sub>C</sub> = -55°C
- ⑦ Does not include tolerance effects from external resistors.
- ⑧ Continuous operation at or above absolute maximum ratings may adversely effect the device performance and/or life cycle.

## APPLICATION NOTES

### MINIMIZING OUTPUT RIPPLE:

The output voltage ripple of the MSK 5012 voltage regulator can be minimized by placing a filter capacitor from the output to ground. The optimum value for this capacitor may vary from one application to the next and is best determined by experimentation. Transient load response can also be improved by placing a capacitor directly across the load. Typically a 10 $\mu$ F capacitor is a good starting point.

### CASE CONNECTIONS:

The case of the MSK 5012 is electrically isolated from the internal circuitry so that a direct connection can be made to the heat sink for most efficient heat dissipation. However, it may be necessary in some applications to connect the case to ground. Grounding the case will help eliminate oscillations and produce a clean, noise free output.

### LOAD REGULATION:

For best results, the ground pin should be connected directly to the load (see next note). This effectively reduces the ground loop effect and eliminates excessive voltage drop in the sense leg. It is also important to keep the output connection between the regulator and the load as short as possible since this directly affects the load regulation. For example, if 20 gauge wire were used which has a resistance of about .008 ohms per foot, this would result in a drop of 8mV/ft at a load current of 1 amp.

### LOAD CONNECTIONS:

In voltage regulator applications where very large load currents are present, the load connection is very important. The path connecting the output of the regulator to the load must be extremely low impedance to avoid affecting the load regulation specifications. Any impedance in this path will form a voltage divider with the load. The same holds true for the connection from the low end of the load to ground. For best load regulation, the low end of the load must be connected directly to pin 2 of the MSK 5012 and not to a ground plane inches away from the hybrid.

### OUTPUT VOLTAGE ADJUSTMENT

The output voltage of the MSK 5012 can be adjusted from +1.3 volts to +36 volts. Refer to the following formula for resistor divider selection. R2 should be 10K $\Omega$  for all applications.

$$R1 = R2 ((V_{OUT} / 1.235) - 1)$$

Figure one below illustrates proper resistor divider connection.

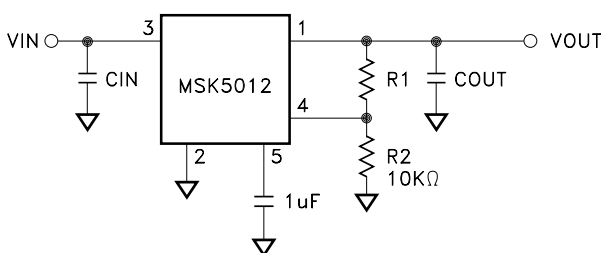

FIGURE 1

### FILTER CAPACITOR:

For all applications, the user must connect a 1.0 $\mu$ F capacitor from pin 5 directly to ground. This capacitor is part of the circuit which drives the gate of the internal MOSFET. Approximately three times the voltage seen on the input will appear across this capacitor. Careful attention must be paid to capacitor voltage rating since voltages larger than the power supply are present.

### HEAT SINK SELECTION:

To select a heat sink for the MSK 5012, the following formula for convective heat flow must be used.

Governing Equation:

$$T_j = P_d \times (R_{\theta jc} + R_{\theta cs} + R_{\theta sa}) + T_a$$

WHERE:

$T_j$  = Junction Temperature

$P_d$  = Total Power Dissipation

$R_{\theta jc}$  = Junction to Case Thermal Resistance

$R_{\theta cs}$  = Case to Heat Sink Thermal Resistance

$R_{\theta sa}$  = Heat Sink to Ambient Thermal Resistance

$T_a$  = Ambient Temperature

First, the power dissipation must be calculated as follows:

$$\text{Power Dissipation} = (V_{in} - V_{out}) \times I_{out}$$

Next, the user must select a maximum junction temperature. The absolute maximum allowable junction temperature is 175 $^{\circ}$ C. The equation may now be rearranged to solve for the required heat sink to ambient thermal resistance ( $R_{\theta sa}$ ).

EXAMPLE:

An MSK 5012 is configured for  $V_{in} = +7V$  and  $V_{out} = +3.3V$ .  $I_{out}$  is a continuous 10A DC level. The ambient temperature is +25 $^{\circ}$ C. The maximum desired junction temperature is 150 $^{\circ}$ C.  $R_{\theta jc} = 0.8^{\circ}$ C/W and  $R_{\theta cs} = 0.15^{\circ}$ C/W typically.

$$\begin{aligned} \text{Power Dissipation} &= (7V - 3.3V) \times (10A) \\ &= 37 \text{ Watts} \end{aligned}$$

Solve for  $R_{\theta sa}$ :

$$R_{\theta sa} = \left[ \frac{150^{\circ}\text{C} - 25^{\circ}\text{C}}{37\text{W}} \right] - 0.8^{\circ}\text{C/W} - 0.15^{\circ}\text{C/W}$$

In this example, a heat sink with a thermal resistance of no more than 2.43 $^{\circ}$ C/W must be used to maintain a junction temperature of no more than 150 $^{\circ}$ C. The Thermalloy Corporation makes a heat sink with a thermal resistance of 2.2 $^{\circ}$ C/W that would work well for this application. (See Thermalloy part number 7023)

### POWER DISSIPATION:

The output pass transistor in the MSK 5012 is rated to dissipate nearly 100 watts. The limiting factor of this device is effective dissipation of heat generated under such conditions. Careful consideration must be paid to heat dissipation and junction temperature when applying this device.

# TYPICAL PERFORMANCE CURVES

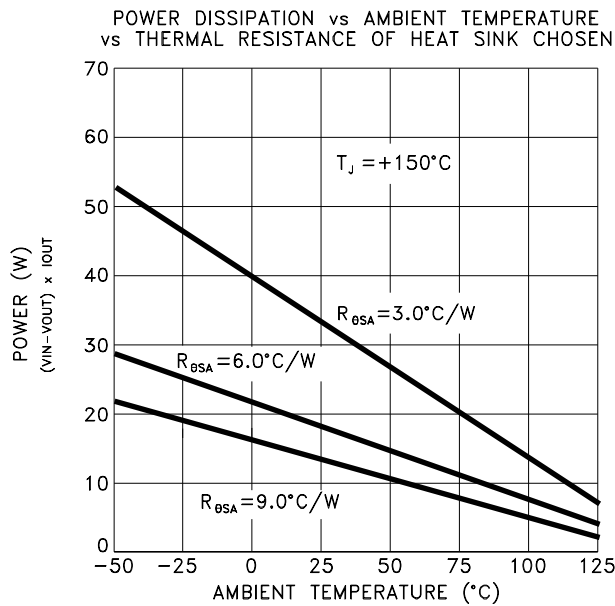
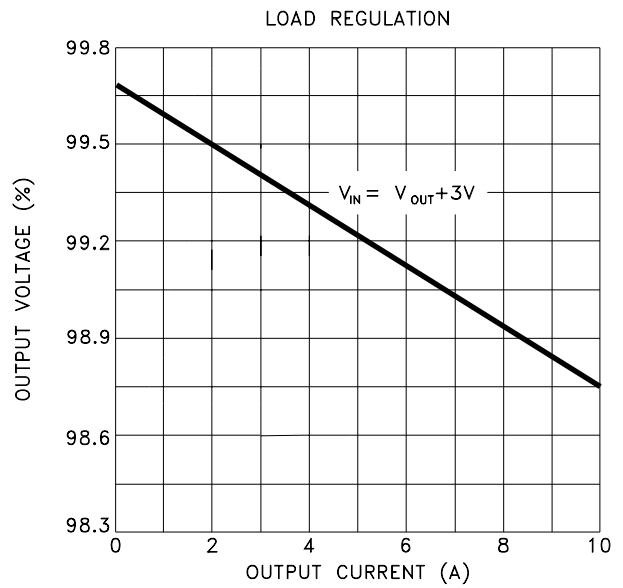
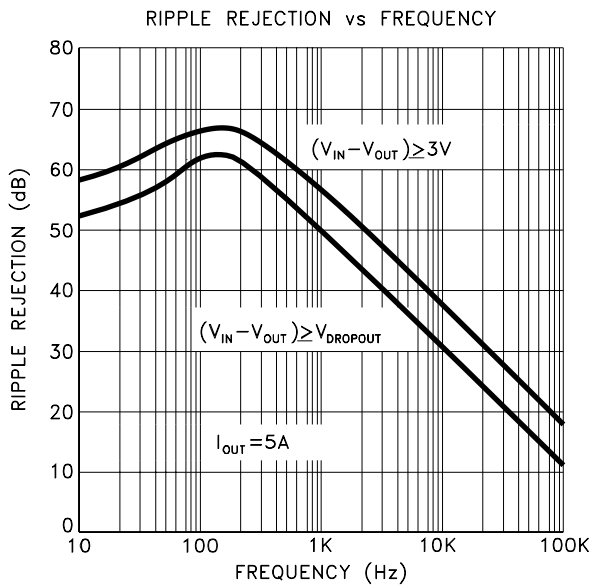
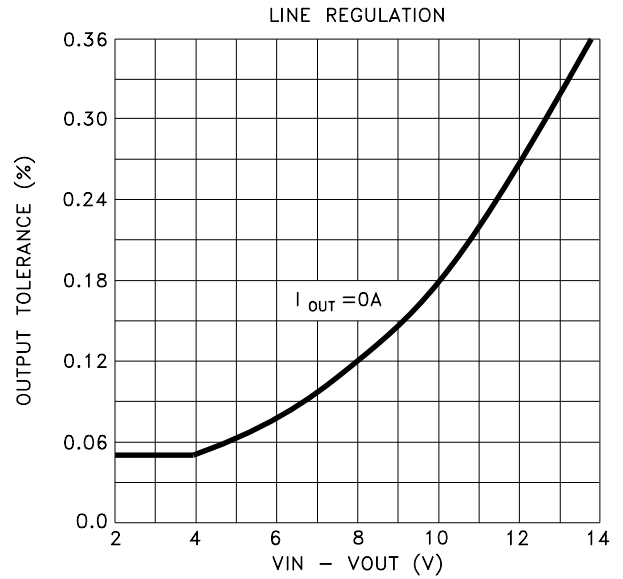
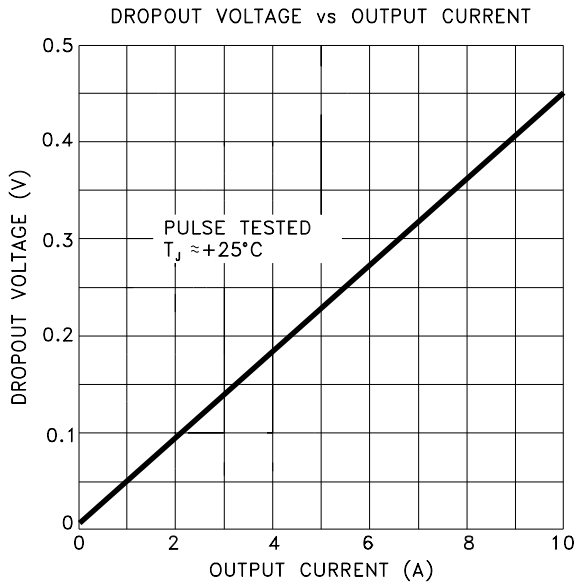

# MECHANICAL SPECIFICATIONS

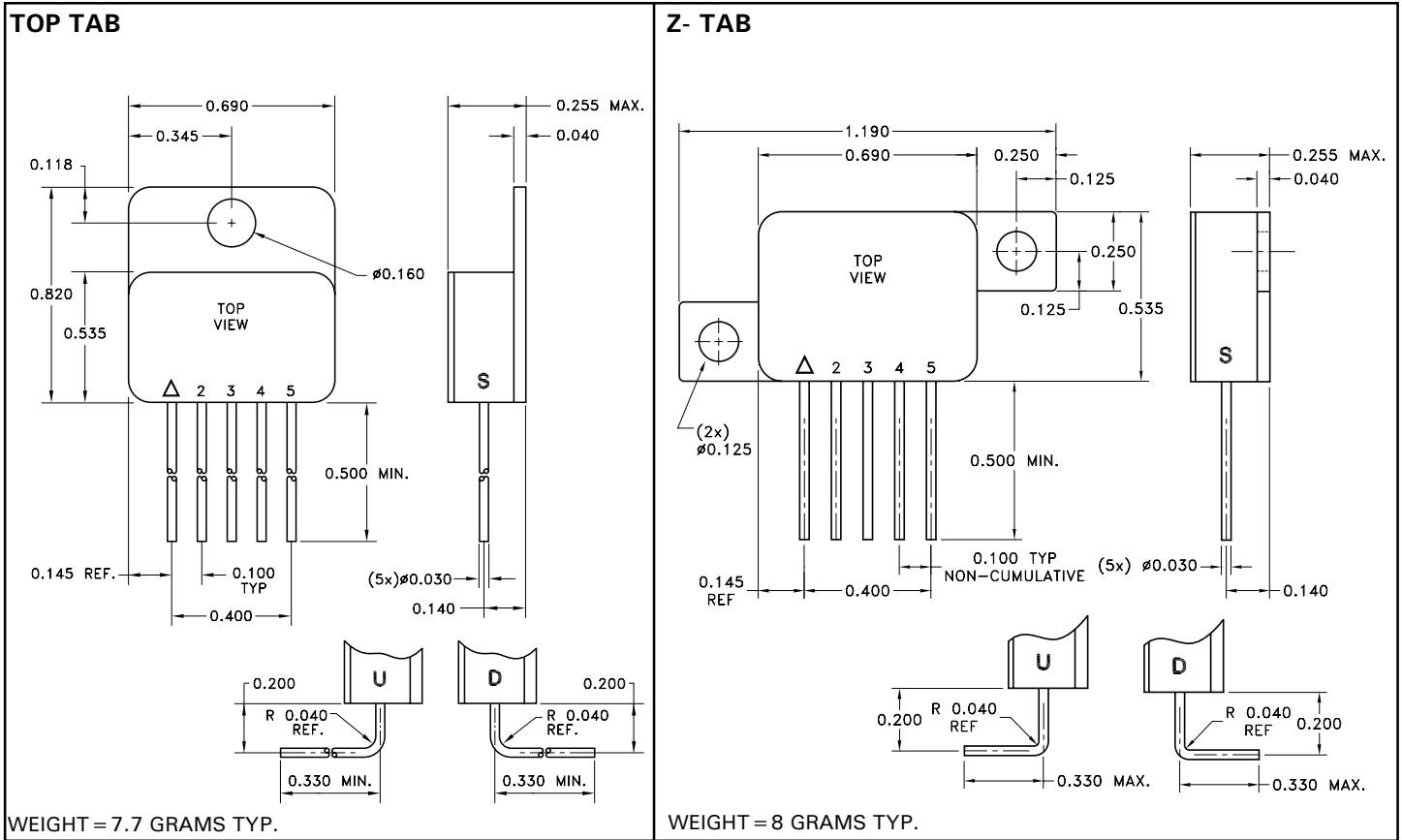

NOTE: ALL DIMENSIONS ARE  $\pm 0.010$  INCHES UNLESS OTHERWISE LABELED.  
ESD Triangle indicates Pin 1.

## ORDERING INFORMATION

MSK5012 B T U

### LEAD CONFIGURATIONS

S = STRAIGHT; U = BENT UP; D = BENT DOWN

### PACKAGE STYLE

T = TOP TAB; Z = Z PACK

### SCREENING

BLANK = INDUSTRIAL; E = EXTENDED RELIABILITY

B = MIL-PRF-38535 CLASS H

### GENERAL PART NUMBER

The above example is a Military grade regulator using the top tab package with leads bent up.

M.S. Kennedy Corp.  
4707 Dey Road, Liverpool, New York 13088  
Phone (315) 701-6751  
FAX (315) 701-6752  
www.mskennedy.com

The information contained herein is believed to be accurate at the time of printing. MSK reserves the right to make changes to its products or specifications without notice, however, and assumes no liability for the use of its products.

Please visit our website for the most recent revision of this datasheet.

Contact MSK for MIL-PRF-38534 qualification status.