

**PLEASE CHECK WWW.MOLEX.COM FOR LATEST PART INFORMATION**

**Part Number:** [54104-5031](#)  
**Status:** **Active**  
**Overview:** FFC-FPC (SMT)  
**Description:** 0.50mm Pitch FFC/FPC Connector, Right Angle, SMT, ZIF, Top Contact Style, 50 Circuits, Lead-Free, 0.1µm Gold (Au) Plating

**Documents:**

[3D Model](#) [Packaging Specification SPK-54104-001 \(PDF\)](#)  
[Drawing \(PDF\)](#) [RoHS Certificate of Compliance \(PDF\)](#)  
[Product Specification PS-54104-071 \(PDF\)](#)

**Agency Certification**

CSA LR19980  
 UL E29179

**General**

Product Family FFC/FPC Connectors  
 Series [54104](#)  
 Overview [FFC-FPC \(SMT\)](#)  
 Product Name N/A  
 UPC 822348532377

**Physical**

Circuits (Loaded) 50  
 Color - Resin Natural  
 Contact Position Top  
 Durability (mating cycles max) 20  
 Entry Angle 90° Angle  
 Flammability 94V-0  
 Mated Height 2.00mm  
 Material - Metal Phosphor Bronze  
 Material - Resin High Temperature Thermoplastic  
 Net Weight 553.150/mg  
 Number of Rows 1  
 Orientation Right Angle  
 PCB Locator No  
 PCB Retention Yes  
 Packaging Type Embossed Tape on Reel  
 Pitch - Mating Interface 0.50mm  
 Polarized to PCB Yes  
 Stackable No  
 Surface Mount Compatible (SMC) N/A  
 Temperature Range - Operating -20°C to +85°C  
 Termination Interface: Style Surface Mount  
 Wire/Cable Type FFC/FPC

**Electrical**

Current - Maximum per Contact 0.5A  
 Voltage - Maximum 50V

**Material Info**

**Reference - Drawing Numbers**

[Packaging Specification](#) SPK-54104-001  
[Product Specification](#) PS-54104-071, RPS-54104-077, RPS-54104-079, RPS-54104-081, RPS-54104-082, RPS-54104-083,

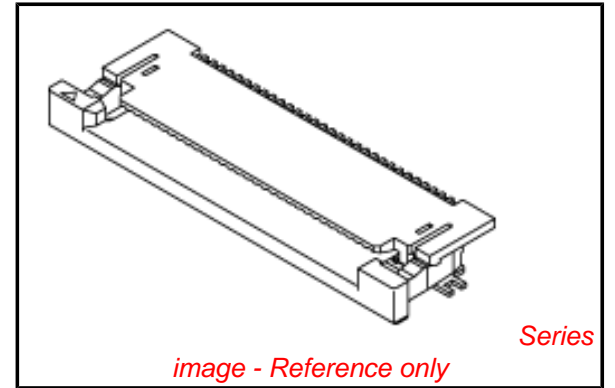

**EU RoHS**

**ELV and RoHS  
 Compliant**  
**REACH SVHC  
 Contains SVHC: No  
 Low-Halogen Status  
 Not Low-Halogen**

**China RoHS**



**Need more information on product environmental compliance?**

Email [productcompliance@molex.com](mailto:productcompliance@molex.com)  
 For a multiple part number RoHS Certificate of Compliance, [click here](#)

Please visit the [Contact Us](#) section for any non-product compliance questions.

**Search Parts in this Series**

[54104Series](#)

Sales Drawing

RPS-54104-084, RPS-54104-086, RPS-54104-088,  
RPS-54104-089, RPS-54104-091, RPS-54104-092  
SD-54104-077, SD-54104-078

This document was generated on 04/15/2013

**PLEASE CHECK [WWW.MOLEX.COM](http://WWW.MOLEX.COM) FOR LATEST PART INFORMATION**