

TOSHIBA Bipolar Linear Integrated Circuit Silicon Monolithic

## TA58L05S, TA58L06S, TA58L08S, TA58L09S TA58L10S, TA58L12S, TA58L15S

### 250 mA Low Dropout Voltage Regulator

The TA58L\*\*S Series consists of fixed-positive-output, low-dropout regulators with an output current of 250 mA (max) that utilize PNP transistors for the output stage. Low dropout voltage and standby current make the TA58L\*\*S Series suitable for applications requiring low power consumption.

#### Features

- Maximum output current : 250 mA
- Output voltage : 5/ 6/ 8/ 9/ 10/ 12/ 15 V
- Output voltage accuracy :  $V_{OUT} \pm 3\%$  (@ $T_j = 25^\circ\text{C}$ )
- Low-dropout voltage : 0.4 V (Max) (@ $I_{OUT} = 200\text{mA}$ )
- Protection function : Over current protection/ thermal shutdown/  
Reverse connection of power supply / 60 V load dump
- Package type : TO-220NIS

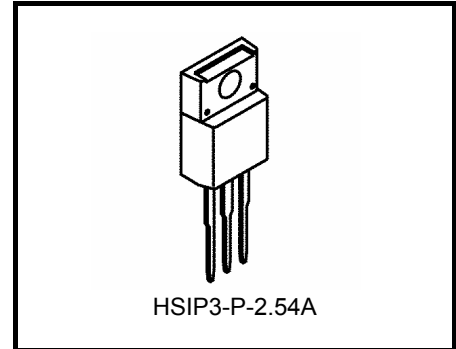

Weight : 1.7 g (Typ.)

#### Pin Assignment

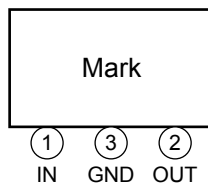

#### Marking

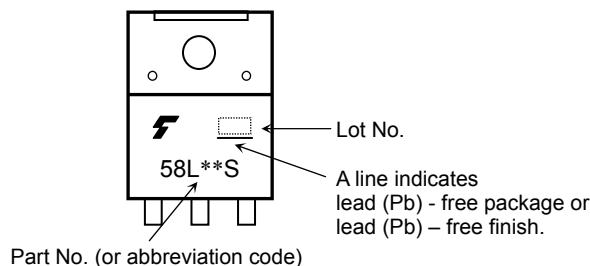

Note 1: The “\*\*” in each product name is replaced with the output voltage of each product.

## Pin Description

Pin No.	Symbol	Description
1	IN	Input terminal. Connected by capacitor ( $C_{IN}$ ) to GND.
3	GND	Ground terminal
2	OUT	Output terminal. Connected by capacitor ( $C_{OUT}$ ) to GND.

## How to Order

Product No.	Package	Package Type and Capacity
TA58L**S(Q) (Note2)	TO-220NIS	Loose in bag: 50 (1 bag)

Note 2: The “\*\*” in each product number is replaced with the output voltage of each product.

## Block Diagram

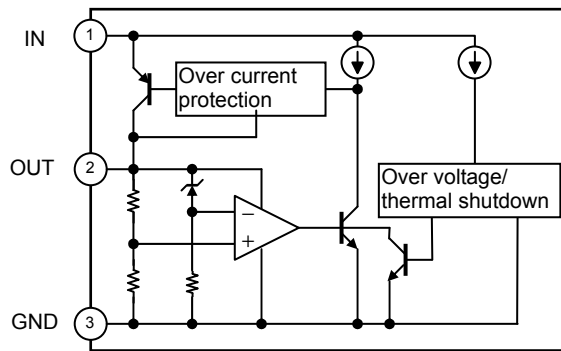

## Absolute Maximum Rating (Ta = 25°C)

Characteristic		Symbol	Rating	Unit
Input voltage	DC	V <sub>IN (DC)</sub>	29	V
	Pulse	V <sub>IN (Pulse)</sub>	60(τ = 200ms)	V
Output current		I <sub>OUT</sub>	250	mA
Operating temperature		T <sub>opr</sub>	-40~105	°C
Junction temperature		T <sub>j</sub>	150	°C
Storage temperature		T <sub>stg</sub>	-55~150	°C
Power dissipation	Ta = 25°C	P <sub>D</sub>	2	W
	Tc = 25°C		20	

Note 3: Do not apply current and voltage (including reverse polarity) to any pin that is not specified.

Note 4: Using continuously under heavy loads (e.g. the application of high temperature/current/voltage and the significant change in temperature, etc.) may cause this product to decrease in the reliability significantly even if the operating conditions (i.e. operating temperature/current/voltage, etc.) are within the absolute maximum ratings and the operating ranges.

Please design the appropriate reliability upon reviewing the Toshiba Semiconductor Reliability Handbook ("Handling Precautions"/Derating Concept and Methods) and individual reliability data (i.e. reliability test report and estimated failure rate, etc).

## Thermal Characteristics

Characteristic	Symbol	Max	Unit
Thermal resistance, junction to ambient	R <sub>th (j-a)</sub>	62.5	°C/ W
Thermal resistance, junction to case	R <sub>th (j-c)</sub>	6.25	°C/ W

## Protection Function (Reference)

Characteristic	Symbol	Test Condition	Min	Typ.	Max	Unit
Thermal shutdown	T <sub>SD</sub>	V <sub>IN</sub> = 14 V (05~06S)/ 16 V (08~10S)/ 18 V (12S)/ 20 V (15S)	—	170	—	°C
Peak circuit current	I <sub>PEAK</sub>	V <sub>IN</sub> = 14 V (05~06S)/ 16 V (08~10S)/ 18 V (12S)/ 20 V (15S), T <sub>j</sub> = 25°C	—	600	—	mA
Short circuit current	I <sub>SC</sub>	V <sub>IN</sub> = 14 V (05~06S)/ 16 V (08~10S)/ 18 V (12S)/ 20 V (15S), T <sub>j</sub> = 25°C	—	330	—	mA
Overvoltage protection	V <sub>IN</sub>	T <sub>j</sub> = 25°C	29	33	—	V

Note4: Ensure that the devices operate within the limits of the maximum rating when in actual use.

Note5: When the input voltage exceeds 29 V, the overvoltage protection circuit is activated to turn off the output voltage.

## TA58L05S

### Electrical Characteristics (unless otherwise specified, $T_j = 25^\circ\text{C}$ )

Characteristic	Symbol	Test Condition	Min	Typ.	Max	Unit
Output voltage	$V_{OUT}$	$V_{IN} = 14\text{ V}, I_{OUT} = 10\text{ mA}$	4.85	5.00	5.15	V
		$5.35\text{ V} \leq V_{IN} \leq 26\text{ V}, I_{OUT} = 10\text{ mA}, -40^\circ\text{C} \leq T_a \leq 105^\circ\text{C}$	4.8	5.0	5.2	
Line regulation	Reg·line	$9\text{ V} \leq V_{IN} \leq 16\text{ V}, I_{OUT} = 10\text{ mA}$	—	1	10	mV
		$5.35\text{ V} \leq V_{IN} \leq 26\text{ V}, I_{OUT} = 10\text{ mA}$	—	2	15	
Load regulation	Reg·load	$V_{IN} = 14\text{ V}, 10\text{ mA} \leq I_{OUT} \leq 250\text{ mA}$	—	10	30	mV
Quiescent current	$I_B$	$6\text{ V} \leq V_{IN} \leq 26\text{ V}, I_{OUT} = 0\text{ A}$	—	0.45	1.00	mA
		$6\text{ V} \leq V_{IN} \leq 26\text{ V}, I_{OUT} = 250\text{ mA}$	—	25	50	
Dropout voltage	$V_D$	$I_{OUT} = 50\text{ mA}$	—	0.08	0.20	V
		$I_{OUT} = 200\text{ mA}$	—	0.22	0.40	

## TA58L06S

### Electrical Characteristics (unless otherwise specified, $T_j = 25^\circ\text{C}$ )

Characteristic	Symbol	Test Condition	Min	Typ.	Max	Unit
Output voltage	$V_{OUT}$	$V_{IN} = 14\text{ V}, I_{OUT} = 10\text{ mA}$	5.82	6.00	6.18	V
		$6.35\text{ V} \leq V_{IN} \leq 26\text{ V}, I_{OUT} = 10\text{ mA}, -40^\circ\text{C} \leq T_a \leq 105^\circ\text{C}$	5.76	6.00	6.24	
Line regulation	Reg·line	$10\text{ V} \leq V_{IN} \leq 17\text{ V}, I_{OUT} = 10\text{ mA}$	—	1	10	mV
		$6.35\text{ V} \leq V_{IN} \leq 26\text{ V}, I_{OUT} = 10\text{ mA}$	—	2	15	
Load regulation	Reg·load	$V_{IN} = 14\text{ V}, 10\text{ mA} \leq I_{OUT} \leq 250\text{ mA}$	—	10	30	mV
Quiescent current	$I_B$	$7\text{ V} \leq V_{IN} \leq 26\text{ V}, I_{OUT} = 0\text{ A}$	—	0.5	1.0	mA
		$7\text{ V} \leq V_{IN} \leq 26\text{ V}, I_{OUT} = 250\text{ mA}$	—	25	50	
Dropout voltage	$V_D$	$I_{OUT} = 50\text{ mA}$	—	0.08	0.20	V
		$I_{OUT} = 200\text{ mA}$	—	0.22	0.40	

## TA58L08S

### Electrical Characteristics (unless otherwise specified, $T_j = 25^\circ\text{C}$ )

Characteristic	Symbol	Test Condition	Min	Typ.	Max	Unit
Output voltage	$V_{\text{OUT}}$	$V_{\text{IN}} = 16 \text{ V}, I_{\text{OUT}} = 10 \text{ mA}$	7.76	8.00	8.24	V
		$8.35 \text{ V} \leq V_{\text{IN}} \leq 26 \text{ V}, I_{\text{OUT}} = 10 \text{ mA}, -40^\circ\text{C} \leq T_a \leq 105^\circ\text{C}$	7.68	8.00	8.32	
Line regulation	Reg·line	$12 \text{ V} \leq V_{\text{IN}} \leq 19 \text{ V}, I_{\text{OUT}} = 10 \text{ mA}$	—	1	10	mV
		$8.35 \text{ V} \leq V_{\text{IN}} \leq 26 \text{ V}, I_{\text{OUT}} = 10 \text{ mA}$	—	2	15	
Load regulation	Reg·load	$V_{\text{IN}} = 16 \text{ V}, 10 \text{ mA} \leq I_{\text{OUT}} \leq 250 \text{ mA}$	—	10	40	mV
Quiescent current	$I_{\text{B}}$	$9 \text{ V} \leq V_{\text{IN}} \leq 26 \text{ V}, I_{\text{OUT}} = 0 \text{ A}$	—	0.55	1.00	mA
		$9 \text{ V} \leq V_{\text{IN}} \leq 26 \text{ V}, I_{\text{OUT}} = 250 \text{ mA}$	—	25	50	
Dropout voltage	$V_{\text{D}}$	$I_{\text{OUT}} = 50 \text{ mA}$	—	0.08	0.20	V
		$I_{\text{OUT}} = 200 \text{ mA}$	—	0.22	0.40	

## TA58L09S

### Electrical Characteristics (unless otherwise specified, $T_j = 25^\circ\text{C}$ )

Characteristic	Symbol	Test Condition	Min	Typ.	Max	Unit
Output voltage	$V_{\text{OUT}}$	$V_{\text{IN}} = 16 \text{ V}, I_{\text{OUT}} = 10 \text{ mA}$	8.73	9.00	9.27	V
		$9.35 \text{ V} \leq V_{\text{IN}} \leq 26 \text{ V}, I_{\text{OUT}} = 10 \text{ mA}, -40^\circ\text{C} \leq T_a \leq 105^\circ\text{C}$	8.64	9.00	9.36	
Line regulation	Reg·line	$13 \text{ V} \leq V_{\text{IN}} \leq 20 \text{ V}, I_{\text{OUT}} = 10 \text{ mA}$	—	1	12	mV
		$9.35 \text{ V} \leq V_{\text{IN}} \leq 26 \text{ V}, I_{\text{OUT}} = 10 \text{ mA}$	—	2	20	
Load regulation	Reg·load	$V_{\text{IN}} = 16 \text{ V}, 10 \text{ mA} \leq I_{\text{OUT}} \leq 250 \text{ mA}$	—	12	40	mV
Quiescent current	$I_{\text{B}}$	$10 \text{ V} \leq V_{\text{IN}} \leq 26 \text{ V}, I_{\text{OUT}} = 0 \text{ A}$	—	0.6	1.0	mA
		$10 \text{ V} \leq V_{\text{IN}} \leq 26 \text{ V}, I_{\text{OUT}} = 250 \text{ mA}$	—	25	50	
Dropout voltage	$V_{\text{D}}$	$I_{\text{OUT}} = 50 \text{ mA}$	—	0.08	0.20	V
		$I_{\text{OUT}} = 200 \text{ mA}$	—	0.22	0.40	

## TA58L10S

### Electrical Characteristics (unless otherwise specified, $T_j = 25^\circ\text{C}$ )

Characteristic	Symbol	Test Condition	Min	Typ.	Max	Unit
Output voltage	$V_{OUT}$	$V_{IN} = 16\text{ V}, I_{OUT} = 10\text{ mA}$	9.7	10.0	10.3	V
		$10.35\text{ V} \leq V_{IN} \leq 26\text{ V}, I_{OUT} = 10\text{ mA}, -40^\circ\text{C} \leq T_a \leq 105^\circ\text{C}$	9.6	10.0	10.4	
Line regulation	Reg·line	$14\text{ V} \leq V_{IN} \leq 21\text{ V}, I_{OUT} = 10\text{ mA}$	—	1	12	mV
		$10.35\text{ V} \leq V_{IN} \leq 26\text{ V}, I_{OUT} = 10\text{ mA}$	—	2	20	
Load regulation	Reg·load	$V_{IN} = 16\text{ V}, 10\text{ mA} \leq I_{OUT} \leq 250\text{ mA}$	—	12	40	mV
Quiescent current	$I_B$	$11\text{ V} \leq V_{IN} \leq 26\text{ V}, I_{OUT} = 0\text{ A}$	—	0.6	1.2	mA
		$11\text{ V} \leq V_{IN} \leq 26\text{ V}, I_{OUT} = 250\text{ mA}$	—	25	50	
Dropout voltage	$V_D$	$I_{OUT} = 50\text{ mA}$	—	0.08	0.20	V
		$I_{OUT} = 200\text{ mA}$	—	0.22	0.40	

## TA58L12S

### Electrical Characteristics (unless otherwise specified, $T_j = 25^\circ\text{C}$ )

Characteristic	Symbol	Test Condition	Min	Typ.	Max	Unit
Output voltage	$V_{OUT}$	$V_{IN} = 18\text{ V}, I_{OUT} = 10\text{ mA}$	11.64	12.00	12.36	V
		$12.35\text{ V} \leq V_{IN} \leq 26\text{ V}, I_{OUT} = 10\text{ mA}, -40^\circ\text{C} \leq T_a \leq 105^\circ\text{C}$	11.52	12.00	12.48	
Line regulation	Reg·line	$16\text{ V} \leq V_{IN} \leq 23\text{ V}, I_{OUT} = 10\text{ mA}$	—	1	12	mV
		$12.35\text{ V} \leq V_{IN} \leq 26\text{ V}, I_{OUT} = 10\text{ mA}$	—	2	20	
Load regulation	Reg·load	$V_{IN} = 18\text{ V}, 10\text{ mA} \leq I_{OUT} \leq 250\text{ mA}$	—	20	50	mV
Quiescent current	$I_B$	$13\text{ V} \leq V_{IN} \leq 26\text{ V}, I_{OUT} = 0\text{ A}$	—	0.65	1.20	mA
		$13\text{ V} \leq V_{IN} \leq 26\text{ V}, I_{OUT} = 250\text{ mA}$	—	25	50	
Dropout voltage	$V_D$	$I_{OUT} = 50\text{ mA}$	—	0.08	0.20	V
		$I_{OUT} = 200\text{ mA}$	—	0.22	0.40	

## TA58L15S

### Electrical Characteristics (unless otherwise specified, $T_j = 25^\circ\text{C}$ )

Characteristic	Symbol	Test Condition	Min	Typ.	Max	Unit
Output voltage	$V_{\text{OUT}}$	$V_{\text{IN}} = 20 \text{ V}, I_{\text{OUT}} = 10 \text{ mA}$	14.55	15.00	15.45	V
		$15.35 \text{ V} \leq V_{\text{IN}} \leq 26 \text{ V}, I_{\text{OUT}} = 10 \text{ mA}, -40^\circ\text{C} \leq T_a \leq 105^\circ\text{C}$	14.4	15.0	15.6	
Line regulation	Reg·line	$19 \text{ V} \leq V_{\text{IN}} \leq 26 \text{ V}, I_{\text{OUT}} = 10 \text{ mA}$	—	1	12	mV
		$15.35 \text{ V} \leq V_{\text{IN}} \leq 26 \text{ V}, I_{\text{OUT}} = 10 \text{ mA}$	—	2	20	
Load regulation	Reg·load	$V_{\text{IN}} = 20 \text{ V}, 10 \text{ mA} \leq I_{\text{OUT}} \leq 250 \text{ mA}$	—	20	60	mV
Quiescent current	$I_{\text{B}}$	$16 \text{ V} \leq V_{\text{IN}} \leq 26 \text{ V}, I_{\text{OUT}} = 0 \text{ A}$	—	0.75	1.40	mA
		$16 \text{ V} \leq V_{\text{IN}} \leq 26 \text{ V}, I_{\text{OUT}} = 250 \text{ mA}$	—	25	50	
Dropout voltage	$V_{\text{D}}$	$I_{\text{OUT}} = 50 \text{ mA}$	—	0.08	0.20	V
		$I_{\text{OUT}} = 200 \text{ mA}$	—	0.22	0.40	

## Electrical Characteristics Common to All Products

- $T_j = 25^\circ\text{C}$  in the measurement conditions of each item is the standard condition when a pulse test is carried out, and any drift in the electrical characteristic due to a rise in the junction temperature of the chip may be disregarded.

## Standard Application Circuit

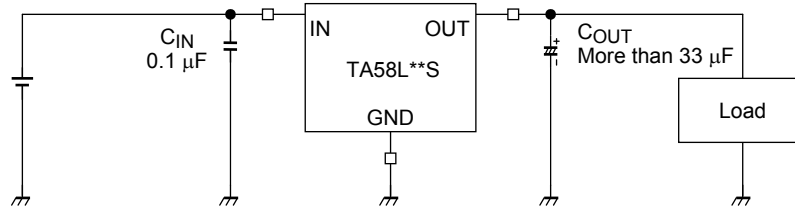

- Place  $C_{IN}$  as close as possible to the input terminal and GND. Place  $C_{OUT}$  as close as possible to the output terminal and GND. Although capacitor  $C_{OUT}$  acts to smooth the dc output voltage during suspension of output oscillation or load change, it might cause output oscillation in a cold environment due to increased capacitor ESR. It is therefore recommended to use a capacitor with small variations temperature sensitivity. Also, ensure that the regulator performance is satisfactory over the operating temperature range of the target system..



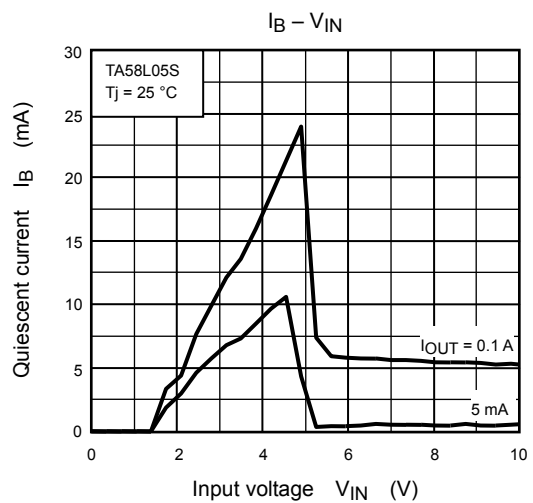
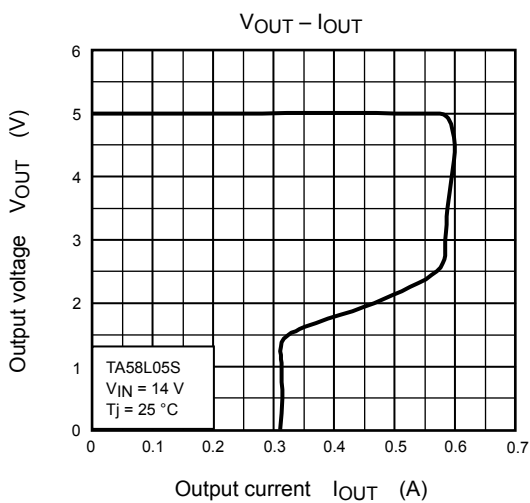
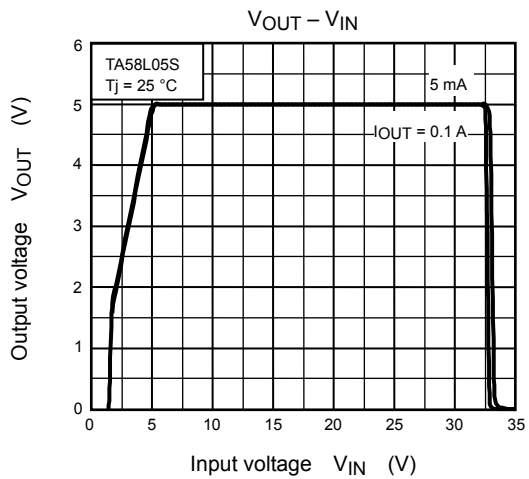
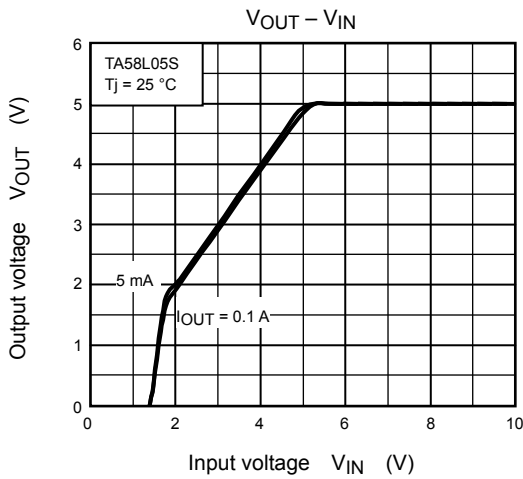
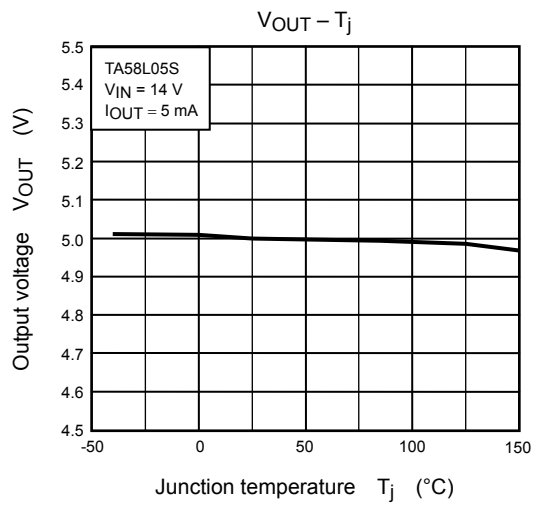
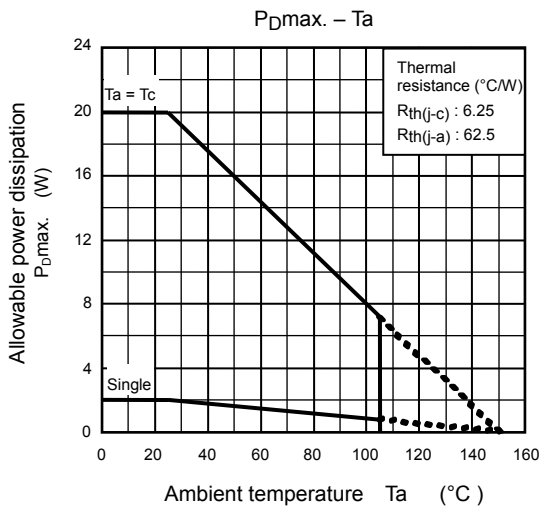

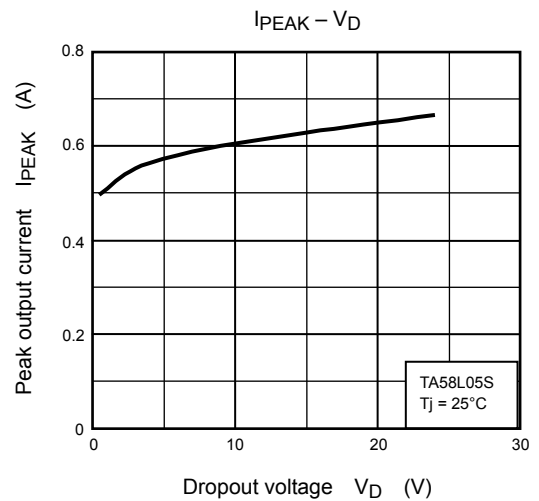
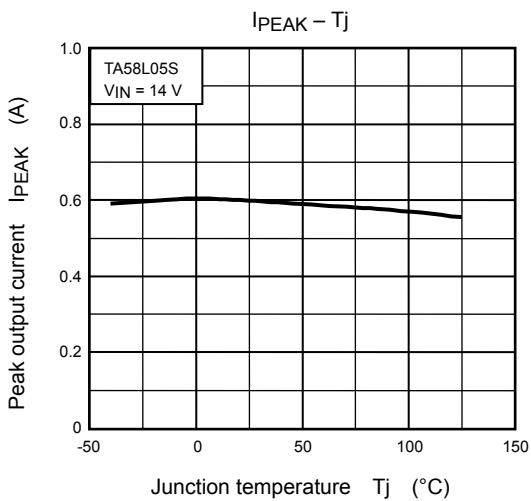
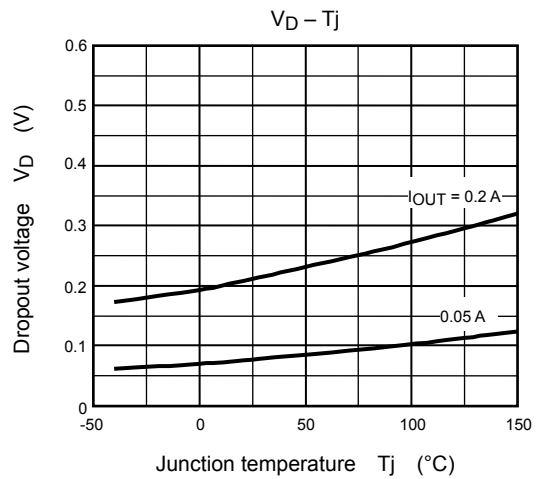
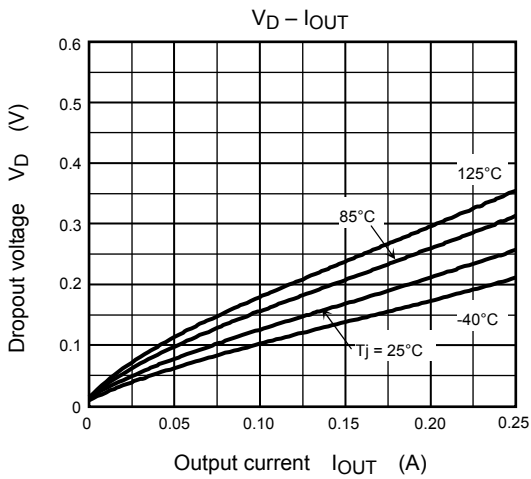
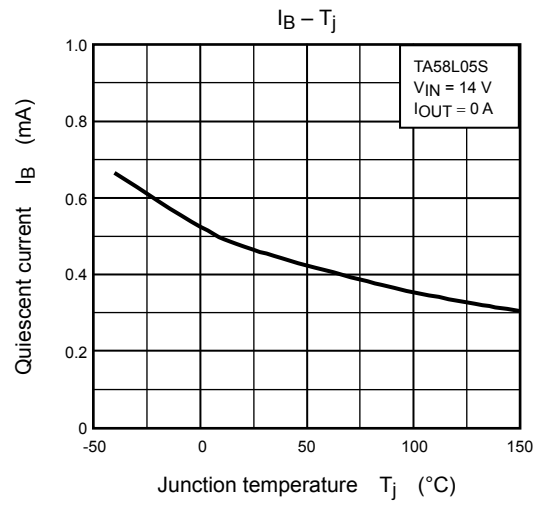
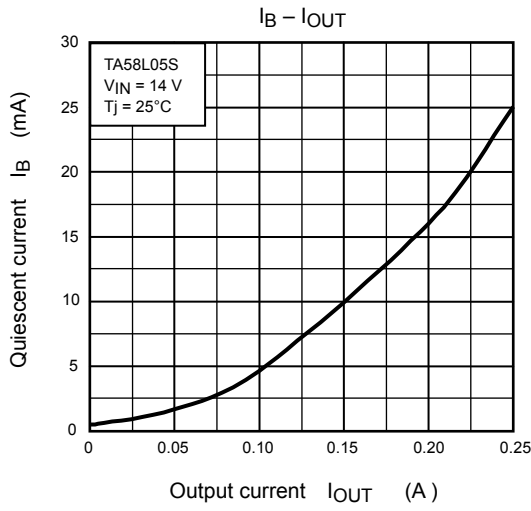

**Package Dimensions**

HSIP3-P-2.54A

Unit : mm

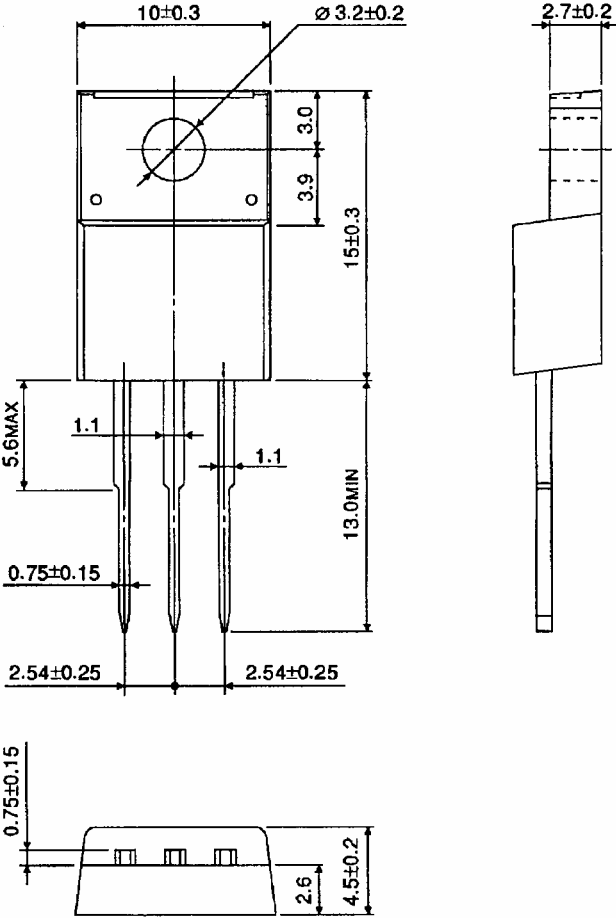

Weight: 1.7 g (Typ.)

**RESTRICTIONS ON PRODUCT USE**

20070701-EN

- The information contained herein is subject to change without notice.
- TOSHIBA is continually working to improve the quality and reliability of its products. Nevertheless, semiconductor devices in general can malfunction or fail due to their inherent electrical sensitivity and vulnerability to physical stress. It is the responsibility of the buyer, when utilizing TOSHIBA products, to comply with the standards of safety in making a safe design for the entire system, and to avoid situations in which a malfunction or failure of such TOSHIBA products could cause loss of human life, bodily injury or damage to property.  
In developing your designs, please ensure that TOSHIBA products are used within specified operating ranges as set forth in the most recent TOSHIBA products specifications. Also, please keep in mind the precautions and conditions set forth in the "Handling Guide for Semiconductor Devices," or "TOSHIBA Semiconductor Reliability Handbook" etc.
- The TOSHIBA products listed in this document are intended for usage in general electronics applications (computer, personal equipment, office equipment, measuring equipment, industrial robotics, domestic appliances, etc.). These TOSHIBA products are neither intended nor warranted for usage in equipment that requires extraordinarily high quality and/or reliability or a malfunction or failure of which may cause loss of human life or bodily injury ("Unintended Usage"). Unintended Usage include atomic energy control instruments, airplane or spaceship instruments, transportation instruments, traffic signal instruments, combustion control instruments, medical instruments, all types of safety devices, etc.. Unintended Usage of TOSHIBA products listed in this document shall be made at the customer's own risk.
- The products described in this document shall not be used or embedded to any downstream products of which manufacture, use and/or sale are prohibited under any applicable laws and regulations.
- The information contained herein is presented only as a guide for the applications of our products. No responsibility is assumed by TOSHIBA for any infringements of patents or other rights of the third parties which may result from its use. No license is granted by implication or otherwise under any patents or other rights of TOSHIBA or the third parties.
- Please contact your sales representative for product-by-product details in this document regarding RoHS compatibility. Please use these products in this document in compliance with all applicable laws and regulations that regulate the inclusion or use of controlled substances. Toshiba assumes no liability for damage or losses occurring as a result of noncompliance with applicable laws and regulations.