

59630 Sensor with Integral Float Actuator

RoHS

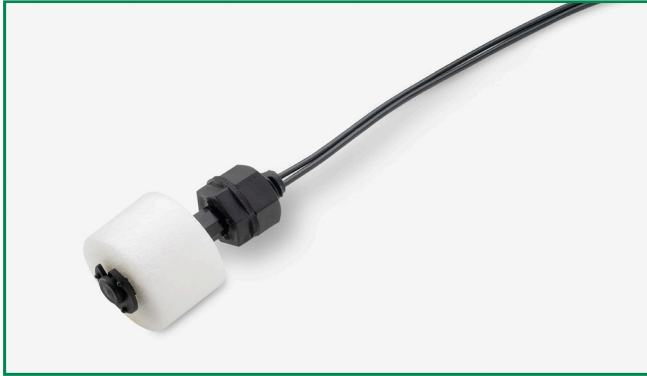

Description

The 59630 is a reed level sensor with integral float actuator and an M8 x 1.25mm pitch thread with a choice of normally open, normally open high voltage, normally closed or change over contacts. It is capable of switching up to 265Vac/300Vdc at 10VA. It is ideally suited to liquid and air conditioning condensate and industrial process control applications.

Features

- Sensor with integral blown polypropylene float, with integral magnet
- Sensor operates when float rises from end stop position
- Choice of contacts
- Choice of connector and cable length options

Dimensions

Dimensions in mm (inch)

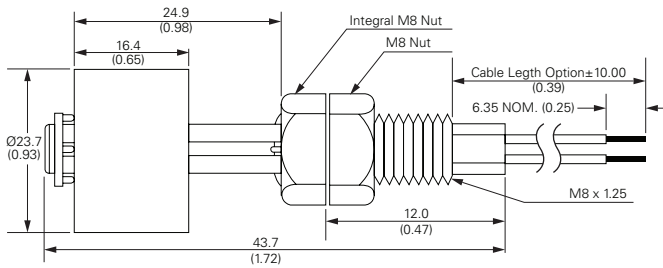

Benefits

- Hermetically sealed, magnetically operated contacts continue to operate long after optical and other technologies fail due to contamination
- No standby power required
- Simple installation with M8 thread and nut

Applications

- Liquid level control
- Air conditioning systems
- Industrial Process Control

Schematics	Switch Type
Black Black	1 and 2
Black Blue White	3
Black Black	4

59630 Sensor with Integral Float Actuator

Electrical Ratings

Contact Type			Normally Open	Normally Open High Voltage	Change Over	Normally Closed
Switch Type			1	2	3	4
Contact Rating ¹		VA/Watt - max.	10	10	5	10
Voltage ⁴	Switching ²	Vdc - max.	200	300	175	200
	Breakdown ³	Vac - max.	140	265	120	120
		Vdc - min.	250	400	200	250
Current ⁴	Switching ²	Adc - max.	0.5	0.4	0.25	0.5
	Carry	Aac - max.	0.35	0.30	0.18	0.18
		Adc - max.	1.2	1.4	1.5	1.2
Resistance ⁵	Contact, Initial Insulation	Ω - max.	0.2	0.2	0.2	0.2
		Ω - min.	10 ¹⁰	10 ¹⁰	10 ⁹	10 ¹⁰
Capacitance	Contact	pF - typ.	0.3	0.2	0.3	0.3
Temperature	Operating	°C	-40 to +105	-20 to +105	-40 to +105	-40 to +105

Product Characteristics

Operate Time ⁶		ms - max.	1.0	1.0	3.0	3.0
Release Time ⁶		ms - max.	1.0	1.0	3.0	3.0
Shock ⁷	11ms ½ sine	G - max.	100	100	50	50
Vibration ⁷	50-2000 Hz	G - max.	30	30	30	30

Notes:

- Contact rating - Product of the switching voltage and current should never exceed the wattage rating. Contact Littelfuse for additional load/life information.
- When switching inductive and/or capacitive loads, the effects of transient voltages and/or currents should be considered. Refer to Application Notes AN108A and AN107 for details.
- Breakdown Voltage - per MIL-STD-202, Method 301.
- Electrical Load Life Expectancy - Contact Littelfuse with voltage, current values along with type of load.
- This resistance value is for 300mm wire length. Resistance varies based on wire length.
- Operate (including bounce)/Release Time - per EIA/NARM RS-421-A, diode suppressed coil (Coil II).
- Shock and Vibration - per EIA/NARM RS-421-A and MIL-STD-202.
- For custom modifications to the wire length or size, or adding a special connector, please contact Littelfuse.

Activation

Using sensor with float magnet orientated is illustrated

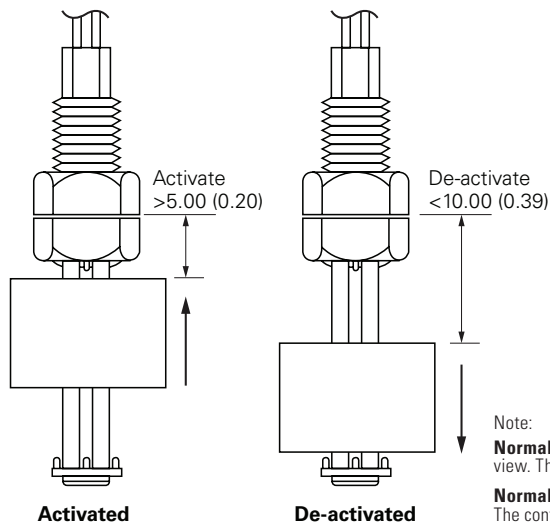

Note:

Normally Open: contacts are open when float is down as shown in the De-activate view. The contacts close when float is in upward position as shown on the left view.

Normally Closed: Contacts are closed when the float is in the down position. The contacts open when float is in the upward position as shown in the left view.

59630 Sensor with Integral Float Actuator

Cable Length Specification

Cable Type: 24 AWG 7/32 PVC 105°C UL1430/UL1569	
Select Option	Cable Length mm (inch)
02	300 (11.81)

Termination Specification

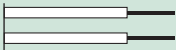
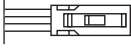
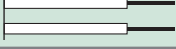
Termination Options		
Select Option	Description (Two-wire versions illustrated)	
A	Tinned leads (6.4±0.76)mm	
D	AMP MTE Connector 2.5mm pitch, 104257-1	
F	Untinned leads (6.4±0.76)mm	

Part Numbering System

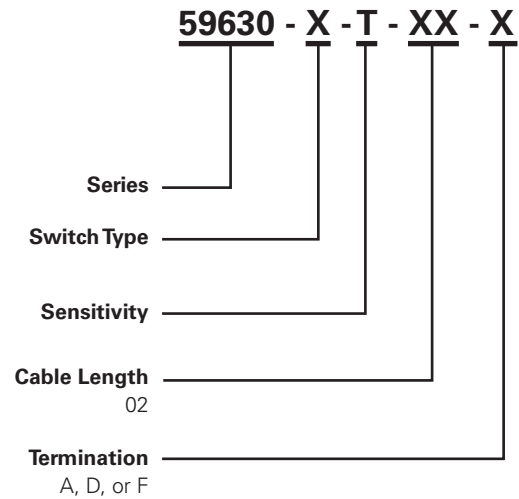

Packaging

Packaging Option	Packaging Specification	Quantity	Quantity & Packaging Code	Taping Width
Bulk	Bulk	500	N/A	N/A