



CHENMKO ENTERPRISE CO.,LTD

GLASS PASSIVATED JUNCTION TRANSIENT VOLTAGE SUPPRESSOR
VOLTAGE-5.0 TO 110 VOLTS
5000 WATTS PEAK POWER 8.0 WATTS STEADY STATE

**5KP
 SERIES**

Lead free devices

FEATURES

- * Plastic package
- * 5000W surge capability at 1ms
- * Glass passivated chip junction in P-6 Package
- * Excellent clamping capability
- * Low Zener Impedance
- * Fast response time: typically less than 1.0ps from 0 volts to BV min.
- * Typical IR less than 1 uA above 10V
- * High temperature soldering guaranteed: 300 degree C/10seconds/.375"(9.5mm) lead length/51 bs., (2.3k) tension

MECHANICAL DATA

Case: JEDEC P-6 molded plastic
Terminals: Plated axial leads, solderable per MIL-STD-750, Method 2026
Polarity: Color band denotes cathode end
Mounting Position: Any
Weight: 0.007 ounce, 2.1 grams

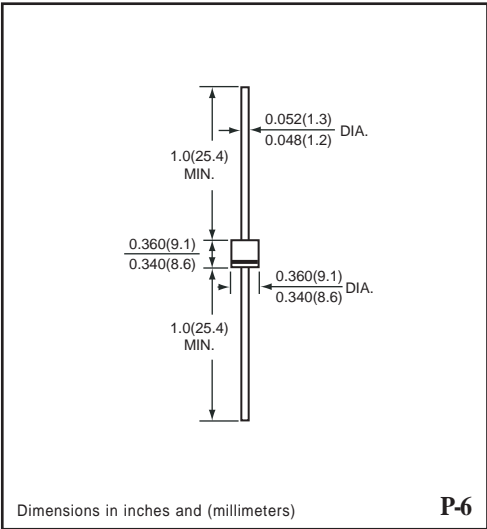
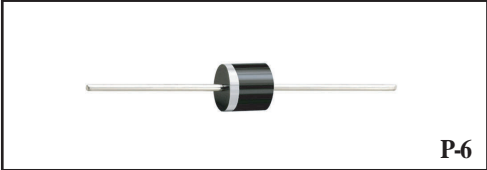

MAXIMUM RATINGS AND ELECTRICAL CHARACTERISTICS

Ratings at 25°C ambient temperature unless otherwise specified.
 Single phase, half wave, 60 Hz, resistive or inductive load.
 For capacitive load, derate current by 20%.

DEVICES FOR BIDIRECTIONAL APPLICATIONS

For Bidirectional use C or CA Suffix for types 5KP5.0 thru types 5KP110
 Electrical characteristics apply in both directions.

MAXIMUM RATINGS (At TA = 25°C unless otherwise noted)

RATINGS	SYMBOL	VALUE	UNITS
Peak Power Dissipation at TA = 25°C, Tp = 1ms (Note1)	PPK	Minimum 5000	Watts
Steady State Power Dissipation at TL = 75°C Lead Lengths .375" (9.5mm)	PD	8.0	Watts
Peak Forward Surge Current 8.3ms Single Half Sine-Wave Superimposed on Rated Load (Note 2)	IFSM	400	Amps
Operating and Storage Temperature Range	TJ, TSTG	-55 to +175	°C

NOTES : 1. Non-repetitive current pulse, per Fig. 3 and derated above TA = 25°C per Fig. 2.
 2. 8.3ms single half sine-wave, duty cycle = 4 pulses per minute maximum.

PRODUCT NO.	Breakdown Voltage			Working Peak Reverse Voltage	Maximum Reverse Leakage at Vrwm	Maximum Reverse Current (NOTE 2)	Maximum Reverse Voltage at Irsm (clamping)	Maximum Temperature Coefficient of Vbr
	VBR Volts (NOTE 1)		@ IT (mA)					
	MIN.	MAX.		Vrwm (V)	Ir (uA)	Irsm (A)	Vrsm (V)	(%C)
5KP5.0PT	6.40	7.30	50	5.0	2000	520	9.6	0.057
5KP5.0APT	6.40	7.00	50	5.0	2000	543	9.2	0.057
5KP6.0PT	6.67	8.15	50	6.0	5000	439	11.4	0.061
5KP6.0APT	6.67	7.37	50	6.0	5000	485	10.3	0.061
5KP6.5PT	7.22	8.82	50	6.5	2000	407	12.3	0.065
5KP6.5APT	7.22	7.98	50	6.5	2000	447	11.2	0.065
5KP7.0PT	7.78	9.51	50	7.0	1000	378	13.3	0.068
5KP7.0APT	7.78	8.60	50	7.0	1000	417	12.0	0.068
5KP7.5PT	8.33	10.2	5.0	7.5	250	350	14.3	0.073
5KP7.5APT	8.33	9.21	5.0	7.5	250	388	12.9	0.073
5KP8.0PT	8.89	10.9	5.0	8.0	150	333	15.0	0.075
5KP8.0APT	8.89	8.83	5.0	8.0	150	367	13.6	0.075
5KP8.5PT	9.44	11.5	5.0	8.5	50.0	314	15.9	0.078
5KP8.5APT	9.44	10.4	5.0	8.5	50.0	347	14.4	0.078
5KP9.0PT	10.0	12.2	5.0	9.0	20.0	295	16.9	0.081
5KP9.0APT	10.0	11.1	5.0	9.0	20.0	325	15.4	0.081
5KP10PT	11.1	13.6	5.0	10.0	15.0	266	18.8	0.084
5KP10APT	11.1	12.3	5.0	10.0	15.0	294	17.0	0.084
5KP11PT	12.2	14.9	5.0	11.0	10.0	249	20.1	0.086
5KP11APT	12.2	13.5	5.0	11.0	10.0	274	18.2	0.086
5KP12PT	13.3	16.3	5.0	12.0	10.0	227	22.0	0.088
5KP12APT	13.3	14.7	5.0	12.0	10.0	251	19.9	0.088
5KP13PT	14.4	17.6	5.0	13.0	10.0	210	23.8	0.090
5KP13APT	14.4	15.9	5.0	13.0	10.0	232	21.5	0.090
5KP14PT	15.6	19.1	5.0	14.0	10.0	194	25.8	0.092
5KP14APT	15.6	17.2	5.0	14.0	10.0	215	23.2	0.092
5KP15PT	16.7	20.4	5.0	15.0	10.0	188	26.9	0.094
5KP15APT	16.7	18.5	5.0	15.0	10.0	206	24.4	0.094
5KP16PT	17.8	21.8	5.0	16.0	10.0	176	28.8	0.096
5KP16APT	17.8	19.7	5.0	16.0	10.0	176	28.8	0.096
5KP17PT	18.9	23.1	5.0	17.0	10.0	164	30.5	0.097
5KP17APT	18.9	20.9	5.0	17.0	10.0	161	27.6	0.097
5KP18PT	20.0	24.4	5.0	18.0	10.0	155	32.2	0.098
5KP18APT	20.0	22.1	5.0	18.0	10.0	172	29.2	0.098
5KP20PT	22.2	27.1	5.0	20.0	10.0	139	35.8	0.099
5KP20APT	22.2	24.5	5.0	20.0	10.0	154	32.4	0.099
5KP22PT	24.4	29.8	5.0	22.0	10.0	127	39.4	0.100
5KP22APT	24.4	26.9	5.0	22.0	10.0	141	35.5	0.100
5KP24PT	26.7	32.6	5.0	24.0	10.0	116	43.0	0.101
5KP24APT	26.7	29.5	5.0	24.0	10.0	128	38.9	0.101
5KP26PT	28.9	35.3	5.0	26.0	10.0	107	46.6	0.101
5KP26APT	28.9	31.9	5.0	26.0	10.0	119	42.1	0.101
5KP28PT	31.1	38.0	5.0	28.0	10.0	99	50.1	0.102
5KP28APT	31.1	34.4	5.0	28.0	10.0	110	45.4	0.102
5KP30PT	33.3	40.7	5.0	30.0	10.0	93	53.5	0.103

PRODUCT NO.	Breakdown Voltage			Working Peak Reverse Voltage	Maximum Reverse Leakage at Vrwm	Maximum Reverse Current (NOTE 2)	Maximum Reverse Voltage at Irsm (clamping)	Maximum Temperature Coefficient of Vbr
	VBR Volts (NOTE 1)		@ IT (mA)					
	MIN.	MAX.		Vrwm (V)	Ir (uA)	Irsm (A)	Vrsm (V)	(%C)
5KP30APT	33.3	36.8	5.0	30.0	10.0	103	48.4	0.103
5KP33PT	36.7	44.9	5.0	33.0	10.0	85	59.0	0.104
5KP33APT	36.7	40.6	5.0	33.0	10.0	94	53.3	0.104
5KP36PT	40.0	48.9	5.0	36.0	10.0	78	64.3	0.104
5KP36APT	40.0	44.2	5.0	36.0	10.0	85	58.1	0.104
5KP40PT	44.4	54.3	5.0	40.0	10.0	70	71.4	0.105
5KP40APT	44.4	49.1	5.0	40.0	10.0	78	64.5	0.105
5KP43PT	47.8	58.4	5.0	43.0	10.0	65	76.7	0.105
5KP43APT	47.8	52.8	5.0	43.0	10.0	72	69.4	0.105
5KP45PT	50.0	61.1	5.0	45.0	10.0	62	80.3	0.106
5KP45APT	50.0	55.3	5.0	45.0	10.0	69	72.7	0.106
5KP48PT	53.3	65.2	5.0	48.0	10.0	58	85.5	0.106
5KP48APT	53.3	58.9	5.0	48.0	10.0	65	77.4	0.106
5KP51PT	56.1	69.3	5.0	51.0	10.0	55	91.1	0.107
5KP51APT	56.7	62.7	5.0	51.0	10.0	61	82.4	0.107
5KP54PT	60.0	73.3	5.0	54.0	10.0	52	96.3	0.107
5KP54APT	60.0	66.3	5.0	54.0	10.0	57	87.1	0.107
5KP58PT	64.4	78.7	5.0	58.0	10.0	49	103	0.107
5KP58APT	64.4	71.2	5.0	58.0	10.0	53	94	0.107
5KP60PT	66.7	81.5	5.0	60.0	10.0	47	107	0.108
5KP60APT	66.7	73.7	5.0	60.0	10.0	52	97	0.108
5KP64PT	71.7	96.9	5.0	64.0	10.0	44	114	0.108
5KP64APT	71.1	78.6	5.0	64.0	10.0	49	103	0.108
5KP70PT	77.6	95.1	5.0	70.0	10.0	40	125	0.108
5KP70APT	77.8	86.0	5.0	70.0	10.0	44	113	0.108
5KP75PT	83.3	102	5.0	75.0	10.0	37	134	0.108
5KP75APT	83.3	92.1	5.0	75.0	10.0	41	121	0.108
5KP78PT	86.7	106.0	5.0	78.0	10.0	36	126	0.108
5KP78APT	86.7	95.8	5.0	78.0	10.0	40	126	0.108
5KP85PT	94.9	115	5.0	85.0	10.0	33	151	0.108
5KP85APT	94.9	104	5.0	85.0	10.0	36	137	0.110
5KP90PT	100	122	5.0	90.0	10.0	31	160	0.110
5KP90APT	100	111	5.0	90.0	10.0	34	146	0.110
5KP100PT	111	136	5.0	100	10.0	28	179	0.110
5KP100APT	111	123	5.0	100	10.0	31	162	0.110
5KP110PT	122	149	5.0	110	10.0	26	196	0.112
5KP110APT	122	135	5.0	110	10.0	28	177	0.112

- NOTES : 1. Vbr measured after IT applied for 300 us. IT = Square Wave Pulse or equivalent.
2. Surge Current Waveform per Figure 3 and Derated per Figure 2.
3. Vf = 3.5 V max. at If= 100 A for all types on 1/2 Square or equivalent Sine Wave.
PW = 8.3 ms, Duty Cycle = 4 Pulses per minute maximum.

RATING CHARACTERISTIC CURVES (5KP5.0PT ~ 5KP110APT)

FIG. 1 - PEAK PULSE POWER RATING CURVE

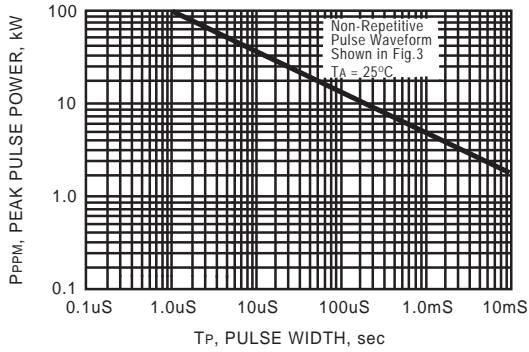

FIG. 2 - PULSE DERATING CURVE

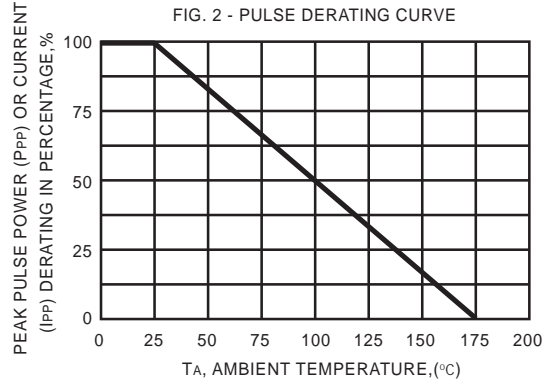

FIG. 3 - PULSE WAVEFORM

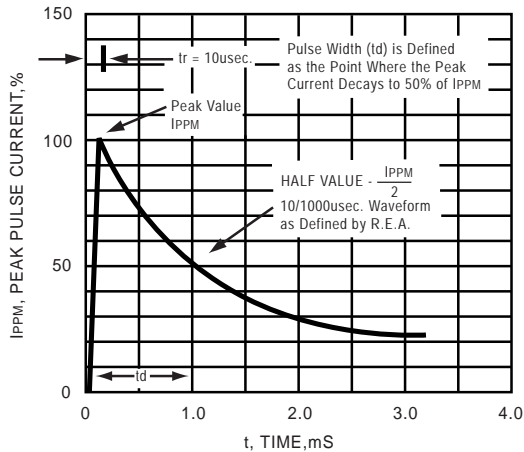

FIG. 4 - TYPICAL JUNCTION CAPACITANCE

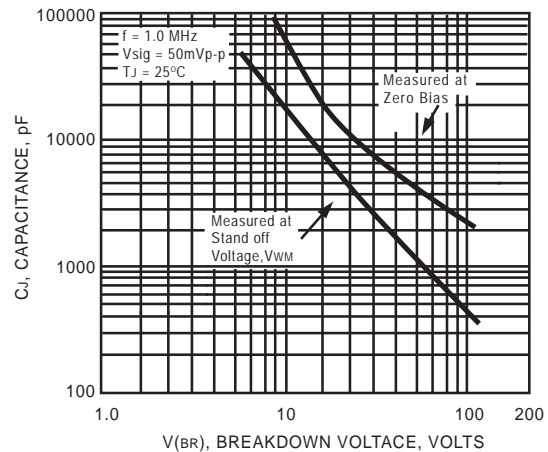

FIG. 5 - STEADY STATE POWER DERATING CURVE

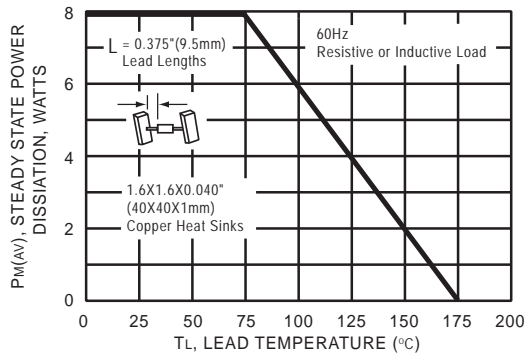

FIG. 6 - MAXIMUM NON-REPETITIVE FORWARD SURGE CURRENT UNI-DIRECTIONAL

