

Axial Lead Transient Voltage Suppressors (TVS)

5KP Series 5.0 To 190 V 5000W

Description

The 5KP series is designed specifically to protect sensitive electronic equipment from voltage transients induced by lightning and other transient voltage events.

Features

- u Glass passivated chip junction in P600 Package
- u Low leakage
- u Uni and Bidirectional unit
- u Excellent clamping capability
- u 5000W Peak power capability at 10 × 1000µs waveform Repetition rate (duty cycle):0.01%
- u Fast response time: typically less than 1.0ps from 0 Volts to V_{BR} min
- u Typical I_R less than 5µA above 12V.
- u High Temperature soldering: 260°C/40 seconds at terminals
- u Typical maximum temperature coefficient $\Delta V_{BR} = 0.1\% \times V_{BR}@25^\circ\text{C} \times \Delta T$
- u Plastic package has Underwriters Laboratory Flammability 94V-0
- u Matte tin lead-free Plated
- u Halogen free and RoHS compliant
- u Typical failure mode is short from over-specified voltage or current
- u Whisker test is conducted based on JEDEC JESD201A per its table 4a and 4c
- u IEC-61000-4-2 ESD 15kV(Air), 8kV (Contact)
- u ESD protection of data lines in accordance with IEC 61000-4-2 (IEC801-2)
- u EFT protection of data lines in accordance with IEC 61000-4-4 (IEC801-4)

Applications

TVS devices are ideal for the protection of I/O interfaces, V_{CC} bus and other vulnerable circuits used in Telecom, Computer, Industrial and Consumer electronic applications.

Uni-directional

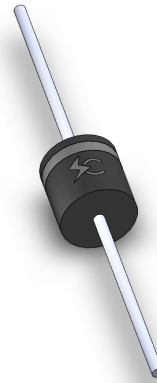

Bi-directional

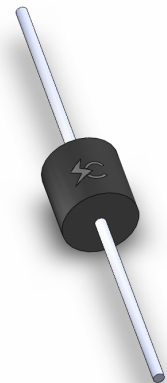

Functional Diagram

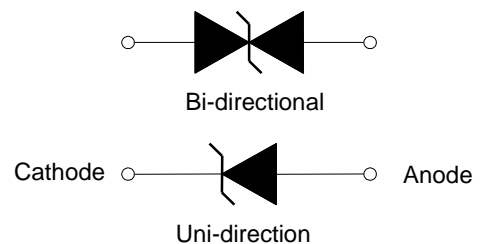

Agency Approvals

AGENCY	AGENCY FILE NUMBER
	E341027

Maximum Ratings ($T_A=25^\circ\text{C}$ unless otherwise noted)

Parameter	Symbol	Value	Unit
Peak Pulse Power Dissipation with a 10/1000µs waveform (Fig.1)(Note 1), (Note 2)	P_{PPM}	5000	Watts
Peak Pulse Current with a 10/1000µs waveform.(Note1, Fig.3)	I_{PP}	See Next Table	Amps
Power Dissipation on Infinite Heat Sink at $T_L=75^\circ\text{C}$	$P_{M(AV)}$	8.0	Watt
Peak Forward Surge Current, 8.3ms Single Half Sine Wave (Note 3)	I_{FSM}	500	Amps
Maximum Instantaneous Forward Voltage at 25A for Unidirectional Only (Note 4)	V_F	3.5/5.0	Voltage
Operating junction and Storage Temperature Range.	T_J, T_{STG}	-55 to +150	$^\circ\text{C}$

Notes:

1. Non-repetitive current pulse, per Fig. 3 and derated above $T_A = 25^\circ\text{C}$ per Fig. 2.
2. Mounted on 5.0mm x 5.0mm (0.03mm thick) Copper Pads to each terminal.
3. 8.3ms single half sine-wave, or equivalent square wave, Duty cycle = 4 pulses per minutes maximum.
4. $V_F < 3.5\text{V}$ for $V_{BR} < 200\text{V}$ and $V_F < 6.5\text{V}$ for $V_{BR} > 201\text{V}$.

Axial Lead Transient Voltage Suppressors (TVS)

5KP Series 5.0 To 190 V 5000W
Electrical Characteristics (T_A=25°C unless otherwise noted)

Part Number		Reverse Stand-Off Voltage V _{RWM} (V)	Breakdown Voltage V _{BR} (V) @I _T		Test Current I _T (mA)	Maximum Clamping Voltage V _C @I _{PP} (V)	Maximum Peak Pulse Current I _{PP} (A)	Maximum Reverse Leakage I _R @V _{RWM} (μA)
Uni	Bi		MIN	MAX				
5KP5.0	5KP5.0C	5.0	6.40	7.30	10	9.6	520.83	800
5KP5.0A	5KP5.0CA	5.0	6.40	7.00	10	9.2	543.48	800
5KP6.0	5KP6.0C	6.0	6.67	8.15	10	11.4	438.60	800
5KP6.0A	5KP6.0CA	6.0	6.67	7.37	10	10.3	485.44	800
5KP6.5	5KP6.5C	6.5	7.22	8.82	10	12.3	406.50	500
5KP6.5A	5KP6.5CA	6.5	7.22	7.98	10	11.2	446.43	500
5KP7.0	5KP7.0C	7.0	7.78	9.51	10	13.3	375.94	200
5KP7.0A	5KP7.0CA	7.0	7.78	8.60	10	12.0	416.67	200
5KP7.5	5KP7.5C	7.5	8.33	10.20	1	14.3	349.65	100
5KP7.5A	5KP7.5CA	7.5	8.33	9.21	1	12.9	387.60	100
5KP8.0	5KP8.0C	8.0	8.89	10.90	1	15.0	333.33	50
5KP8.0A	5KP8.0CA	8.0	8.89	9.83	1	13.6	367.65	50
5KP8.5	5KP8.5C	8.5	9.44	11.50	1	15.9	314.47	20
5KP8.5A	5KP8.5CA	8.5	9.44	10.40	1	14.4	347.22	20
5KP9.0	5KP9.0C	9.0	10.00	12.20	1	16.9	295.86	10
5KP9.0A	5KP9.0CA	9.0	10.00	11.10	1	15.4	324.68	10
5KP10	5KP10C	10.0	11.10	13.60	1	18.8	265.96	5
5KP10A	5KP10CA	10.0	11.10	12.30	1	17.0	294.12	5
5KP11	5KP11C	11.0	12.20	14.90	1	20.1	248.76	5
5KP11A	5KP11CA	11.0	12.20	13.50	1	18.2	274.73	5
5KP12	5KP12C	12.0	13.30	16.30	1	22.0	227.27	5
5KP12A	5KP12CA	12.0	13.30	14.70	1	19.9	251.26	5
5KP13	5KP13C	13.0	14.40	17.60	1	23.8	210.08	5
5KP13A	5KP13CA	13.0	14.40	15.90	1	21.5	232.56	5
5KP14	5KP14C	14.0	15.60	19.10	1	25.8	193.80	5
5KP14A	5KP14CA	14.0	15.60	17.20	1	23.2	215.52	5
5KP15	5KP15C	15.0	16.70	20.40	1	26.9	185.87	5
5KP15A	5KP15CA	15.0	16.70	18.50	1	24.4	204.92	5
5KP16	5KP16C	16.0	17.80	21.80	1	28.8	173.61	5
5KP16A	5KP16CA	16.0	17.80	19.70	1	26.0	192.31	5
5KP17	5KP17C	17.0	18.90	23.10	1	30.5	163.93	5
5KP17A	5KP17CA	17.0	18.90	20.90	1	27.6	181.16	5
5KP18	5KP18C	18.0	20.00	24.40	1	32.2	155.28	5
5KP18A	5KP18CA	18.0	20.00	22.10	1	29.2	171.23	5
5KP19	5KP19C	19.0	21.13	25.76	1	34.0	147.02	5
5KP19A	5KP19CA	19.0	21.10	23.30	1	30.8	162.44	5
5KP20	5KP20C	20.0	22.20	27.10	1	35.8	139.66	5
5KP20A	5KP20CA	20.0	22.20	24.50	1	32.4	154.32	5
5KP22	5KP22C	22.0	24.40	29.80	1	39.4	126.90	5
5KP22A	5KP22CA	22.0	24.40	26.90	1	35.5	140.85	5
5KP24	5KP24C	24.0	26.70	32.60	1	43.0	116.28	5
5KP24A	5KP24CA	24.0	26.70	29.50	1	38.9	128.53	5
5KP26	5KP26C	26.0	28.90	35.30	1	46.6	107.30	5
5KP26A	5KP26CA	26.0	28.90	31.90	1	42.1	118.76	5
5KP28	5KP28C	28.0	31.10	38.00	1	50.0	100.00	5
5KP28A	5KP28CA	28.0	31.10	34.40	1	45.4	110.13	5
5KP30	5KP30C	30.0	33.30	40.70	1	53.5	93.46	5
5KP30A	5KP30CA	30.0	33.30	36.80	1	48.4	103.31	5
5KP33	5KP33C	33.0	36.70	44.90	1	59.0	84.75	5
5KP33A	5KP33CA	33.0	36.70	40.60	1	53.3	93.81	5
5KP36	5KP36C	36.0	40.00	48.90	1	64.3	77.76	5
5KP36A	5KP36CA	36.0	40.00	44.20	1	58.1	86.06	5
5KP40	5KP40C	40.0	44.40	54.30	1	71.4	70.03	5
5KP40A	5KP40CA	40.0	44.40	49.10	1	64.5	77.52	5
5KP43	5KP43C	43.0	47.80	58.40	1	76.7	65.19	5
5KP43A	5KP43CA	43.0	47.80	52.80	1	69.4	72.05	5

Axial Lead Transient Voltage Suppressors (TVS)

5KP Series 5.0 To 190 V 5000W

Electrical Characteristics ($T_A=25^\circ\text{C}$ unless otherwise noted) (Continue)

Part Number		Reverse Stand-Off Voltage V_{RWM} (V)	Breakdown Voltage V_{BR} (V) @ I_T		Test Current I_T (mA)	Maximum Clamping Voltage V_C @ I_{PP} (V)	Maximum Peak Pulse Current I_{PP} (A)	Maximum Reverse Leakage I_R @ V_{RWM} (μA)
Uni	Bi		MIN	MAX				
5KP45	5KP45C	45.0	50.00	61.10	1	80.3	62.27	5
5KP45A	5KP45CA	45.0	50.00	55.30	1	72.7	68.78	5
5KP48	5KP48C	48.0	53.30	65.10	1	85.5	58.48	5
5KP48A	5KP48CA	48.0	53.30	58.90	1	77.4	64.60	5
5KP51	5KP51C	51.0	56.70	69.30	1	91.1	54.88	5
5KP51A	5KP51CA	51.0	56.70	62.70	1	82.4	60.68	5
5KP54	5KP54C	54.0	60.00	73.30	1	96.3	51.92	5
5KP54A	5KP54CA	54.0	60.00	66.30	1	87.1	57.41	5
5KP58	5KP58C	58.0	64.40	78.70	1	103.0	48.54	5
5KP58A	5KP58CA	58.0	64.40	71.20	1	93.6	53.42	5
5KP60	5KP60C	60.0	66.70	81.50	1	107.0	46.73	5
5KP60A	5KP60CA	60.0	66.70	73.70	1	96.8	51.65	5
5KP64	5KP64C	64.0	71.10	86.90	1	114.0	43.86	5
5KP64A	5KP64CA	64.0	71.10	78.60	1	103.0	48.54	5
5KP70	5KP70C	70.0	77.80	95.10	1	125.0	40.00	5
5KP70A	5KP70CA	70.0	77.80	86.00	1	113.0	44.25	5
5KP75	5KP75C	75.0	83.30	102.00	1	134.0	37.31	5
5KP75A	5KP75CA	75.0	83.30	92.10	1	121.0	41.32	5
5KP78	5KP78C	78.0	86.70	106.00	1	139.0	35.97	5
5KP78A	5KP78CA	78.0	86.70	95.80	1	126.0	39.68	5
5KP80	5KP80C	80.0	88.96	108.80	1	143.2	34.92	5
5KP80A	5KP80CA	80.0	88.80	97.60	1	129.6	38.58	5
5KP85	5KP85C	85.0	94.40	115.00	1	151.0	33.11	5
5KP85A	5KP85CA	85.0	94.40	104.00	1	137.0	36.50	5
5KP90	5KP90C	90.0	100.00	122.00	1	160.0	31.25	5
5KP90A	5KP90CA	90.0	100.00	111.00	1	146.0	34.25	5
5KP100	5KP100C	100.0	111.00	136.00	1	179.0	27.93	5
5KP100A	5KP100CA	100.0	111.00	123.00	1	162.0	30.86	5
5KP110	5KP110C	110.0	122.00	149.00	1	196.0	25.51	5
5KP110A	5KP110CA	110.0	122.00	135.00	1	177.0	28.25	5
5KP120	5KP120C	120.0	133.00	163.00	1	214.0	23.36	5
5KP120A	5KP120CA	120.0	133.00	147.00	1	193.0	25.91	5
5KP130	5KP130C	130.0	144.00	176.00	1	231.0	21.65	5
5KP130A	5KP130CA	130.0	144.00	159.00	1	209.0	23.92	5
5KP140	5KP140C	140.0	155.68	190.40	1	250.6	19.95	5
5KP140A	5KP140CA	140.0	155.00	171.00	1	226.8	22.05	5
5KP150	5KP150C	150.0	167.00	204.00	1	268.0	18.66	5
5KP150A	5KP150CA	150.0	167.00	185.00	1	243.0	20.58	5
5KP160	5KP160C	160.0	178.00	218.00	1	287.0	17.42	5
5KP160A	5KP160CA	160.0	178.00	197.00	1	259.0	19.31	5
5KP170	5KP170C	170.0	189.00	231.00	1	304.0	16.45	5
5KP170A	5KP170CA	170.0	189.00	209.00	1	275.0	18.18	5
5KP180	5KP180C	180.0	201.00	244.80	1	322.2	15.52	5
5KP180A	5KP180CA	180.0	201.00	220.00	1	291.6	17.15	5
5KP190	5KP190C	190.0	211.21	258.40	1	340.1	14.70	5
5KP190A	5KP190CA	190.0	211.00	232.00	1	307.8	16.24	5

Note:

1. Suffix 'A' denotes 5% tolerance device. Without 'A' denotes 10% tolerance device
2. Add suffix 'C' or 'CA' after part number to specify Bi-directional devices
3. For Bi-Directional devices having V_R of 10 volts and under, the I_R limit is double

Axial Lead Transient Voltage Suppressors (TVS)

5KP Series 5.0 To 190 V 5000W

Ratings and Characteristic Curves ($T_A=25^\circ\text{C}$ unless otherwise noted)

Figure 1 - Peak Pulse Power Rating Curve

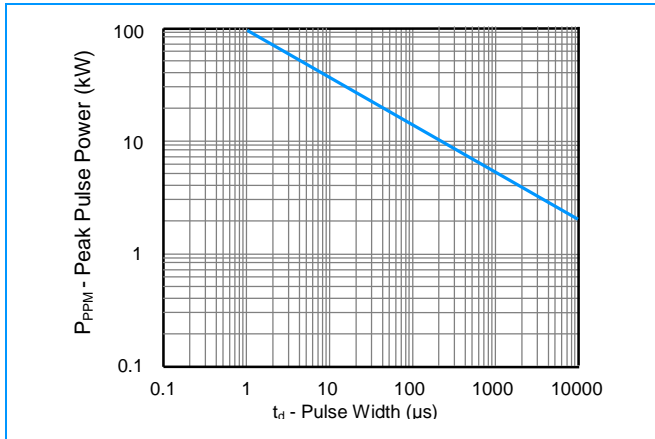

Figure 2 - Pulse Derating Curve

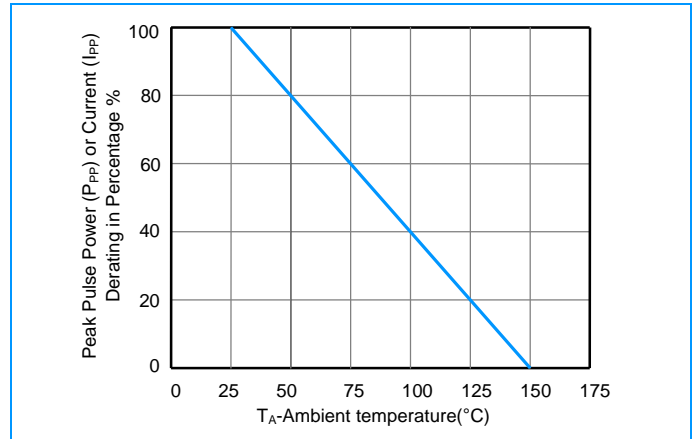

Figure 3 - Pulse Waveform

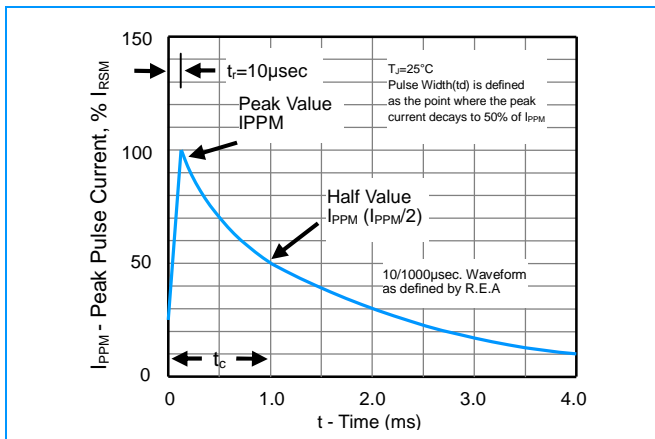

Figure 4 - Typical Junction Capacitance

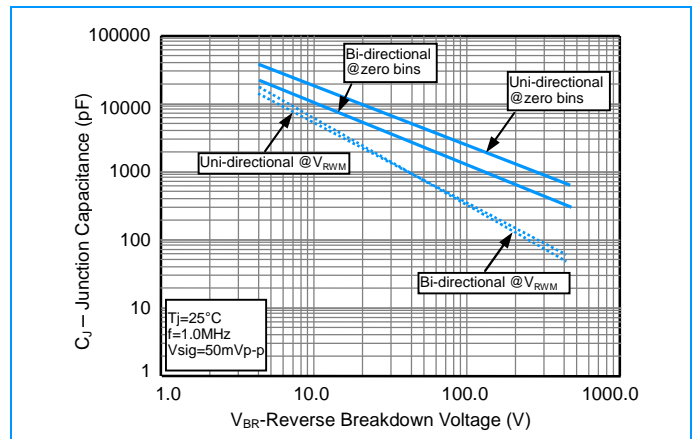

Figure 5 - Steady State Power Derating Curve

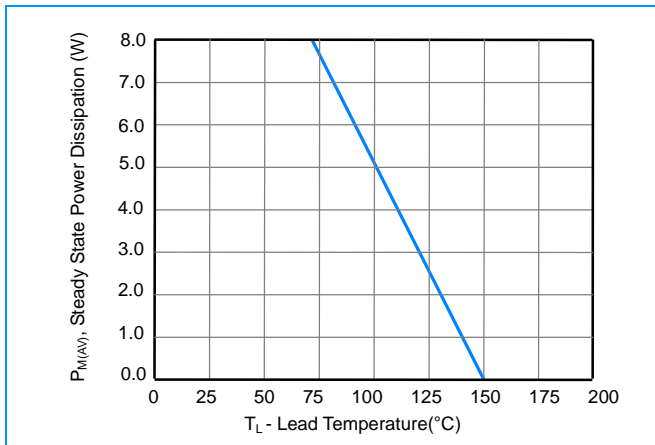
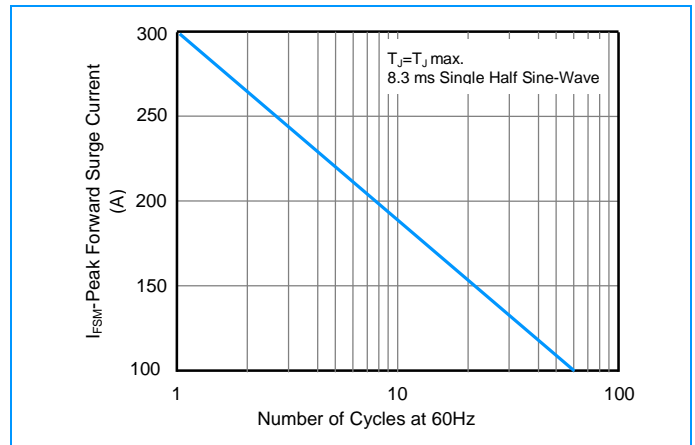

Figure 6 - Maximum Non-Repetitive Surge Current



Axial Lead Transient Voltage Suppressors (TVS)

5KP Series 5.0 To 190 V 5000W

I-V Curve Characteristics

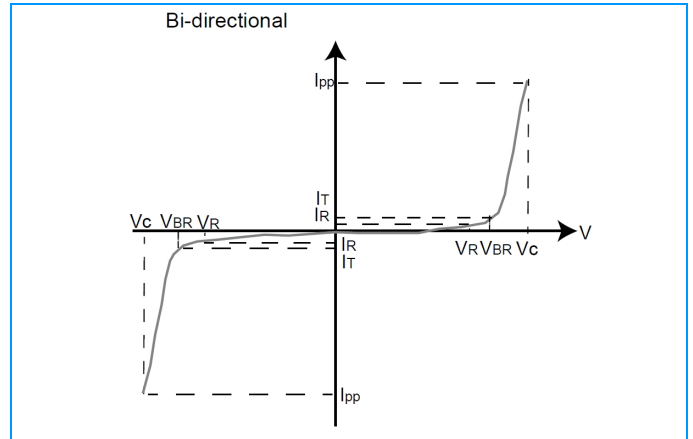
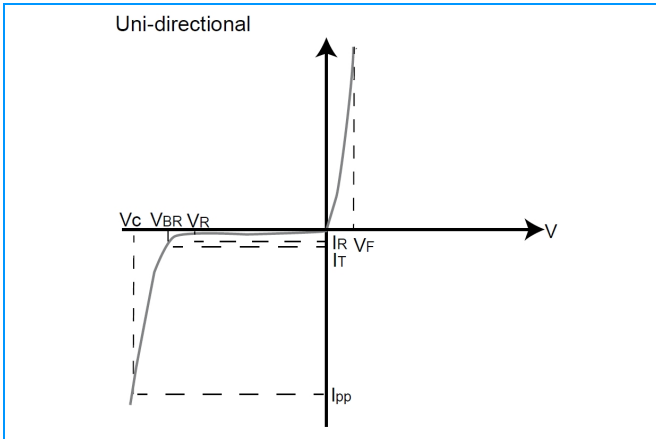

Physical Specifications

Weight	0.07 ounce, 2.1gram
Case	JEDEC R-6/P600 Molded Plastic over glass passivated junction
Polarity	Color band denotes cathode except Bipolar
Terminal	Matte Tin-plated leads, Solderable per JESD22-B102D

Environmental Specifications

Temperature Cycle	JESD22-A104
Pressure Cooker	JESD22-A102
High Temp. Storage	JESD22-A103
HTRB	JESD22-A108
Thermal Shock	JESD22-A106

Soldering Parameters

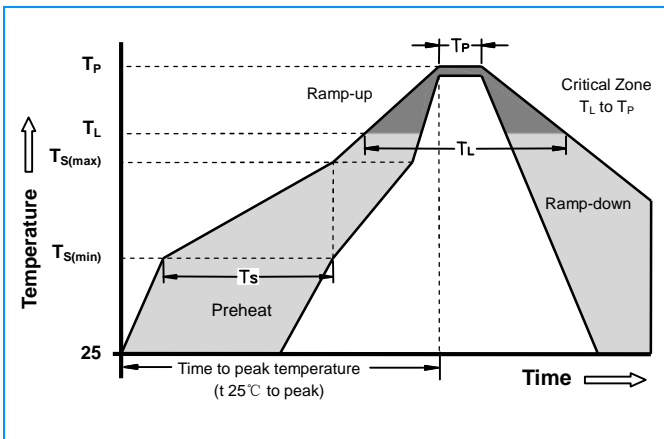

Reflow Condition		Lead-free assembly
Pre Heat	-Temperature Min ($T_{S(min)}$)	150°C
	-Temperature Max ($T_{S(max)}$)	200°C
	- Time (min to max) (t_s)	60 -180 Seconds
Average ramp up rate (Liquidus Temp T_L) to peak		3°C/second max
$T_{S(max)}$ to T_L - Ramp-up Rate		3°C/second max
Reflow	- Temperature (T_L) (Liquidus)	217°C
	- Time (min to max) (t_s)	60 -150 Seconds
Peak Temperature (T_P)		260 +0/-5°C
Time within 5°C of actual peak Temperature (t_p)		20 -40 Seconds
Ramp-down Rate		6°C/second max
Time 25°C to peak Temperature (T_P)		8 minutes Max
Do not exceed		280°C

Axial Lead Transient Voltage Suppressors (TVS)

5KP Series 5.0 To 190 V 5000W

Dimensions

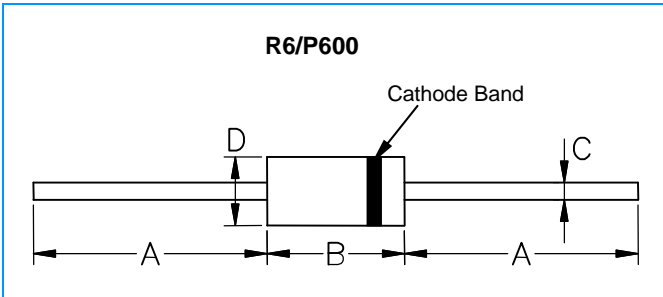

Dimensions	Inches		Millimeters	
	Min	Max	Min	Max
A	1.000	-	25.40	-
B	0.340	0.360	8.64	9.14
C	0.048	0.052	1.22	1.32
D	0.340	0.360	8.64	9.14

Part Numbering

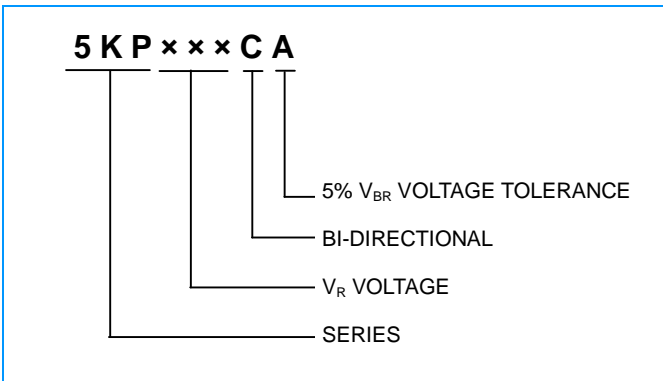

Part Marking

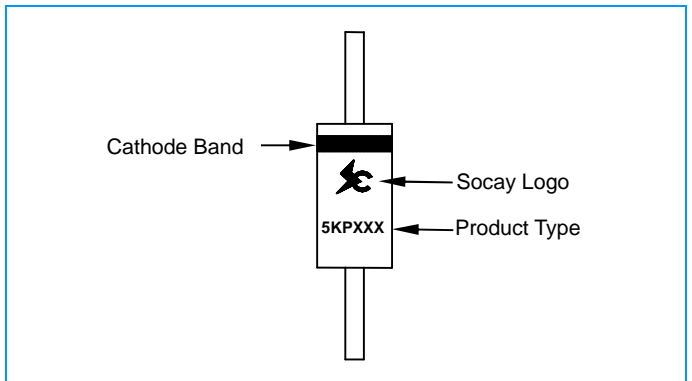

Packaging

Part Number	Component Package	Quantity	Packaging Option
5KPXXXXX	R6/P600	200	Box

Packaging Dimensions Unit: Inches (Millimeters)

