

FRED Ultrafast Soft Recovery Diode, 60 A

FEATURES

- Ultrafast recovery
- 175 °C operating junction temperature
- Designed and qualified for industrial level

BENEFITS

- Reduced RFI and EMI
- Higher frequency operation
- Reduced snubbing
- Reduced parts count

DESCRIPTION/APPLICATIONS

These diodes are optimized to reduce losses and EMI/RFI in high frequency power conditioning systems. The softness of the recovery eliminates the need for a snubber in most applications. These devices are ideally suited for HF welding, power converters and other applications where switching losses are not significant portion of the total losses.

N-60EPU06



Cathode to base

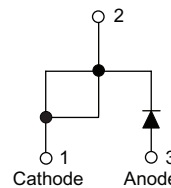

TO-247AC modified

N-60APU06

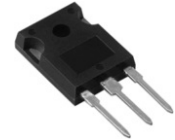

Cathode to base

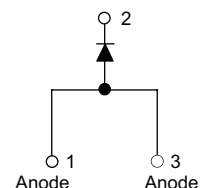

TO-247AB

PRODUCT SUMMARY

t_{rr}	34 ns
$I_{F(AV)}$	60 A
V_R	600 V

ABSOLUTE MAXIMUM RATINGS

PARAMETER	SYMBOL	TEST CONDITIONS	VALUES	UNITS
Cathode to anode voltage	V_R		600	V
Continuous forward current	$I_{F(AV)}$	$T_C = 116\text{ °C}$	60	A
Single pulse forward current	I_{FSM}	$T_C = 25\text{ °C}$	600	
Maximum repetitive forward current	I_{FRM}	Square wave, 20 kHz	120	
Operating junction and storage temperatures	T_J, T_{Stg}		- 55 to 175	°C

ELECTRICAL SPECIFICATIONS ($T_J = 25\text{ °C}$ unless otherwise specified)

PARAMETER	SYMBOL	TEST CONDITIONS	MIN.	TYP.	MAX.	UNITS
Breakdown voltage, blocking voltage	V_{BR}, V_R	$I_R = 100\text{ }\mu\text{A}$	600	-	-	V
Forward voltage	V_F	$I_F = 60\text{ A}$	-	1.50	1.75	
		$I_F = 60\text{ A}, T_J = 125\text{ °C}$	-	1.30	1.55	
		$I_F = 60\text{ A}, T_J = 175\text{ °C}$	-	1.20	1.40	
Reverse leakage current	I_R	$V_R = V_R\text{ rated}$	-	-	50	μA
		$T_J = 150\text{ °C}, V_R = V_R\text{ rated}$	-	-	500	
Junction capacitance	C_T	$V_R = 600\text{ V}$	-	39	-	pF

DYNAMIC RECOVERY CHARACTERISTICS (T _J = 25 °C unless otherwise specified)						
PARAMETER	SYMBOL	TEST CONDITIONS	MIN.	TYP.	MAX.	UNITS
Reverse recovery time	t _{rr}	I _F = 0.5A, I _R = 1A, I _{RR} = 0.25A (RG#1 CKT)	-	38	45	ns
		I _F = 1A, dI _F /dt = 200 A/μs, V _R = 30V	-	30	45	
		T _J = 25°C	-	81	-	
		T _J = 125°C	-	164	-	
Peak recovery current	I _{RRM}	T _J = 25°C	-	7.4	-	A
		T _J = 125°C	-	17	-	
Reverse recovery charge	Q _{rr}	T _J = 25°C	-	300	-	nC
		T _J = 125°C	-	1394	-	

THERMAL - MECHANICAL SPECIFICATIONS						
PARAMETER	SYMBOL	TEST CONDITIONS	MIN.	TYP.	MAX.	UNITS
Thermal resistance, junction to case	R _{thJC}		-	-	0.63	°C/W
Thermal resistance, case to heatsink	R _{thCS}	Mounting surface, flat, smooth and greased	-	0.2	-	
Weight			-	5.5	-	g
			-	0.2	-	oz.
Mounting torque			1.2 (10)	-	2.4 (20)	N · m (lbf · in)
Marking device		Case style TO-247AC modified	60EPU06			
		Case style TO-247AC	60APU06			

Fig.1 Typical forward voltage drop characteristics

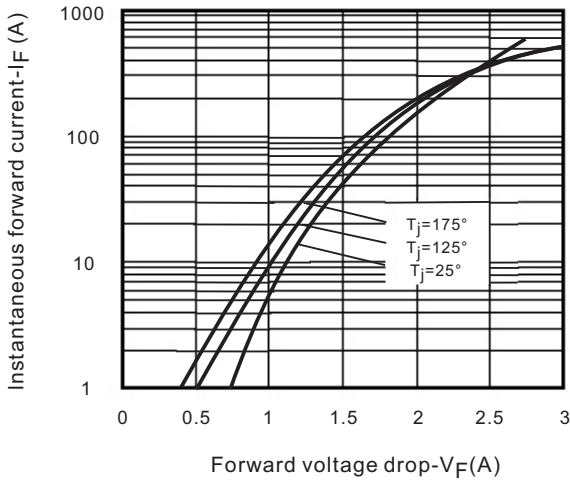

Fig.2 Typical values of reverse current vs. reverse voltage

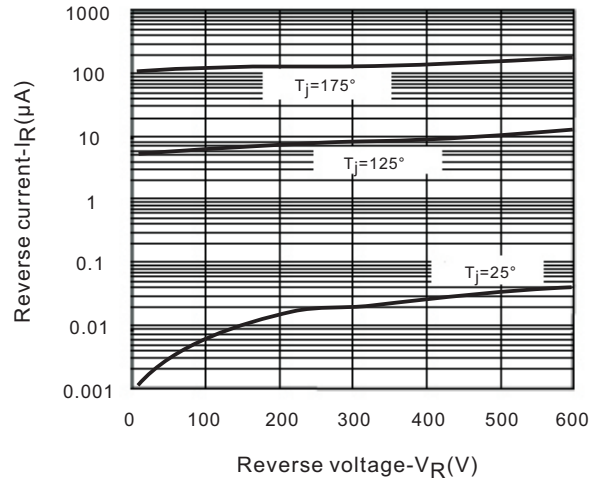

Fig.3 Typical junction capacitance vs. reverse voltage

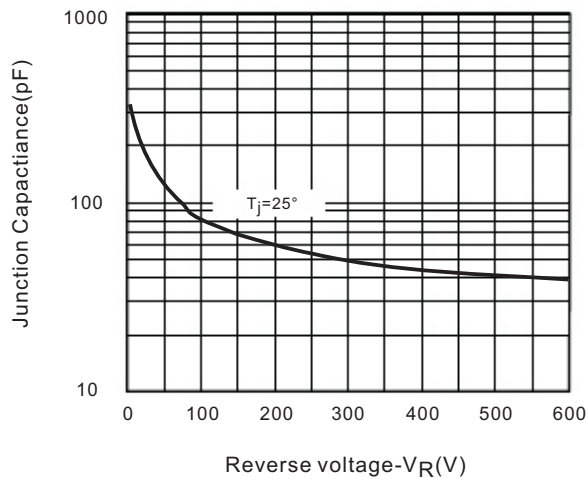
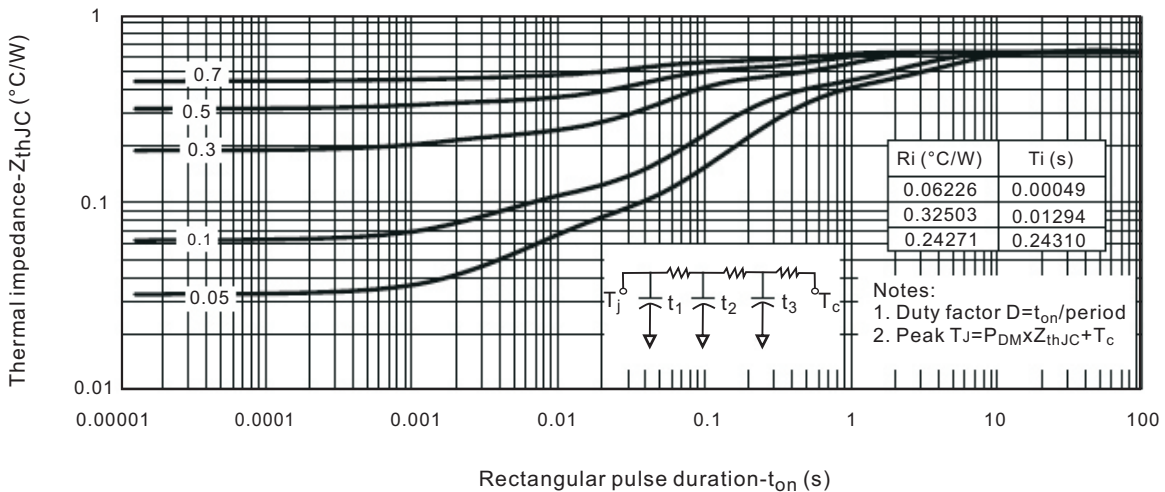

Fig4. Maximum thermal impedance Z_{thJC} characteristics



Nell High Power Products

Fig.5 Max. Allowable Case Temperature Vs. Average Forward Current

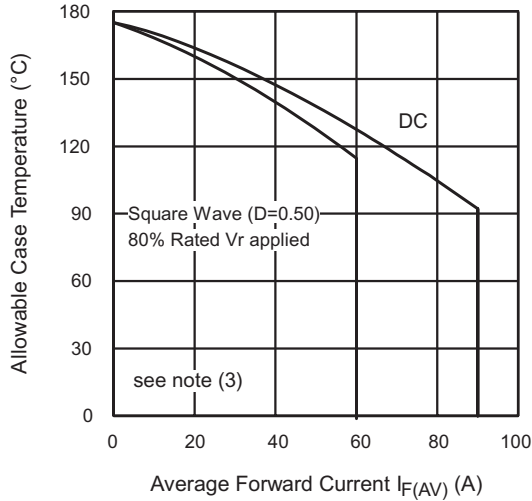

Fig.6 Forward Power Loss Characteristics

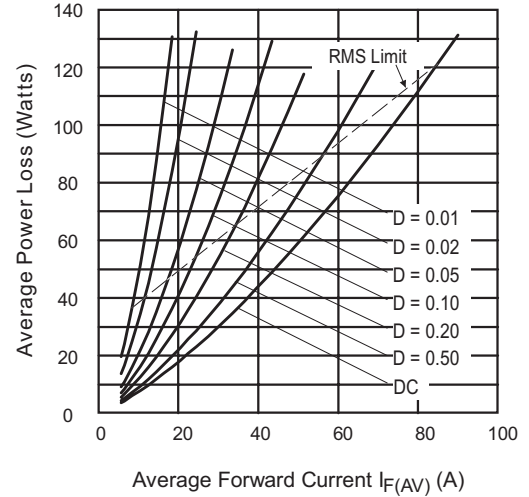

Fig.7 Typical Stored Charge vs. di_F/dt

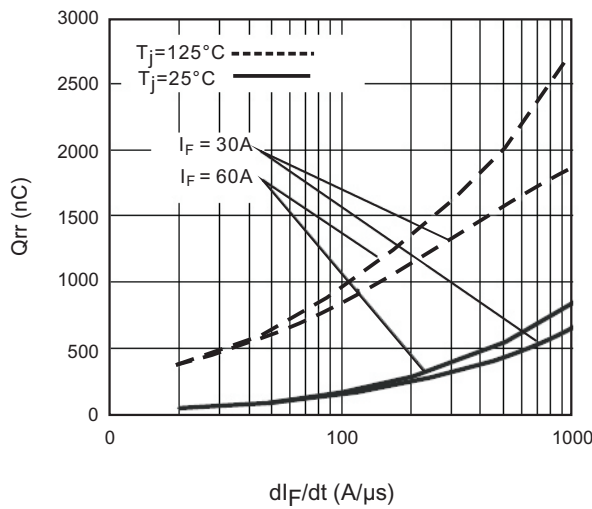
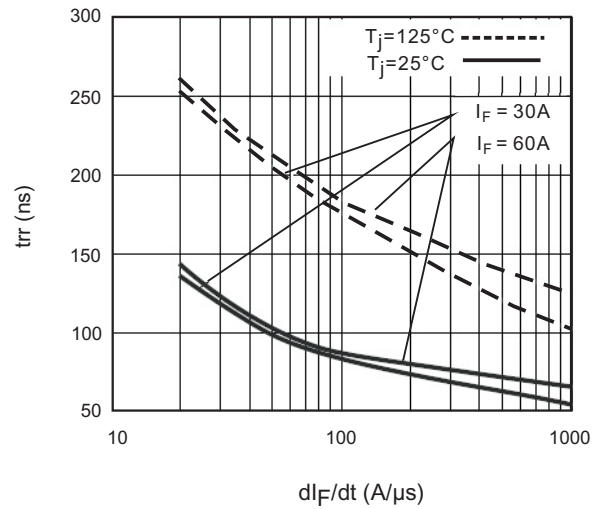

Fig.8 Typical Reverse Recovery Time vs. di_F/dt



Ordering Information Table

Device code

N	-	60	E	P	U	06
①		②	③	④	⑤	⑥

- ① - Nell
- ② - Current rating (60 = 60A)
- ③ - Single Diode
- ④ - TO-247AC (Modified)
- ⑤ - Ultrafast Recovery
- ⑥ - Voltage Rating (06 = 600 V)

E = 2 pins
A = 3 pins

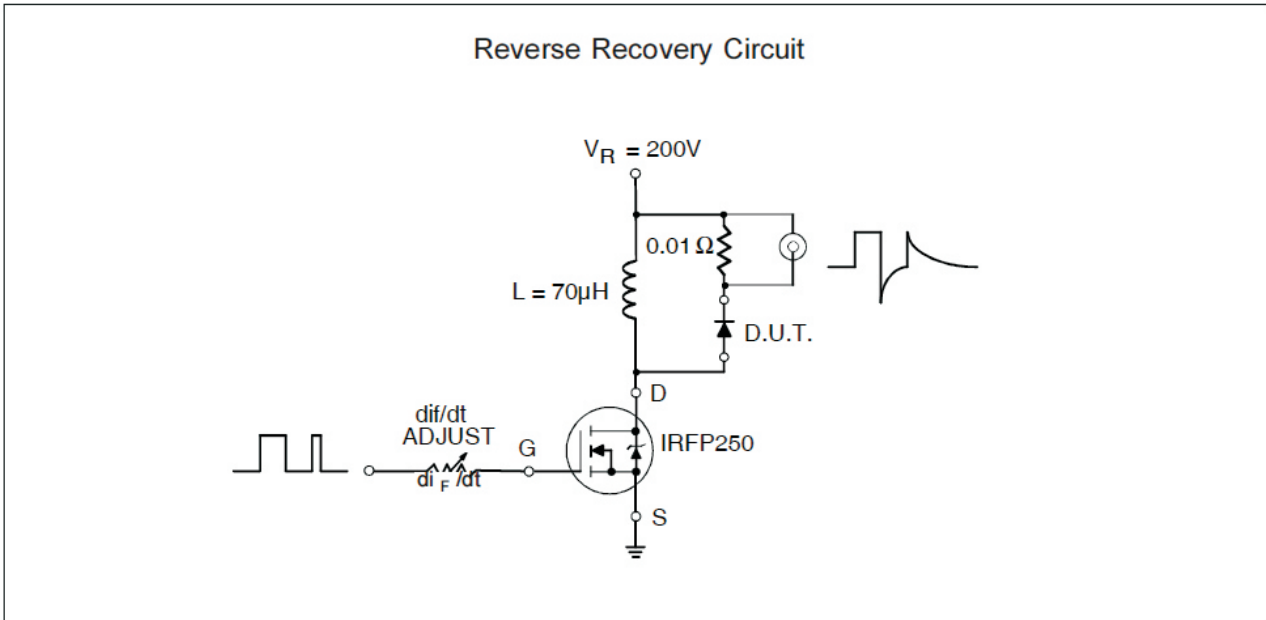
Fig.9 Reverse recovery parameter test circuit

- (3) Formula used: $T_C = T_J - (Pd + Pd_{REV}) \times R_{thJC}$;
 $Pd = \text{Forward Power Loss} = I_{F(AV)} \times V_{FM} @ (I_{F(AV)} / D)$ (see Fig. 6);
 $Pd_{REV} = \text{Inverse Power Loss} = V_{R1} \times I_R (1 - D)$; $I_R @ V_{R1} = 80\% \text{ rated } V_R$

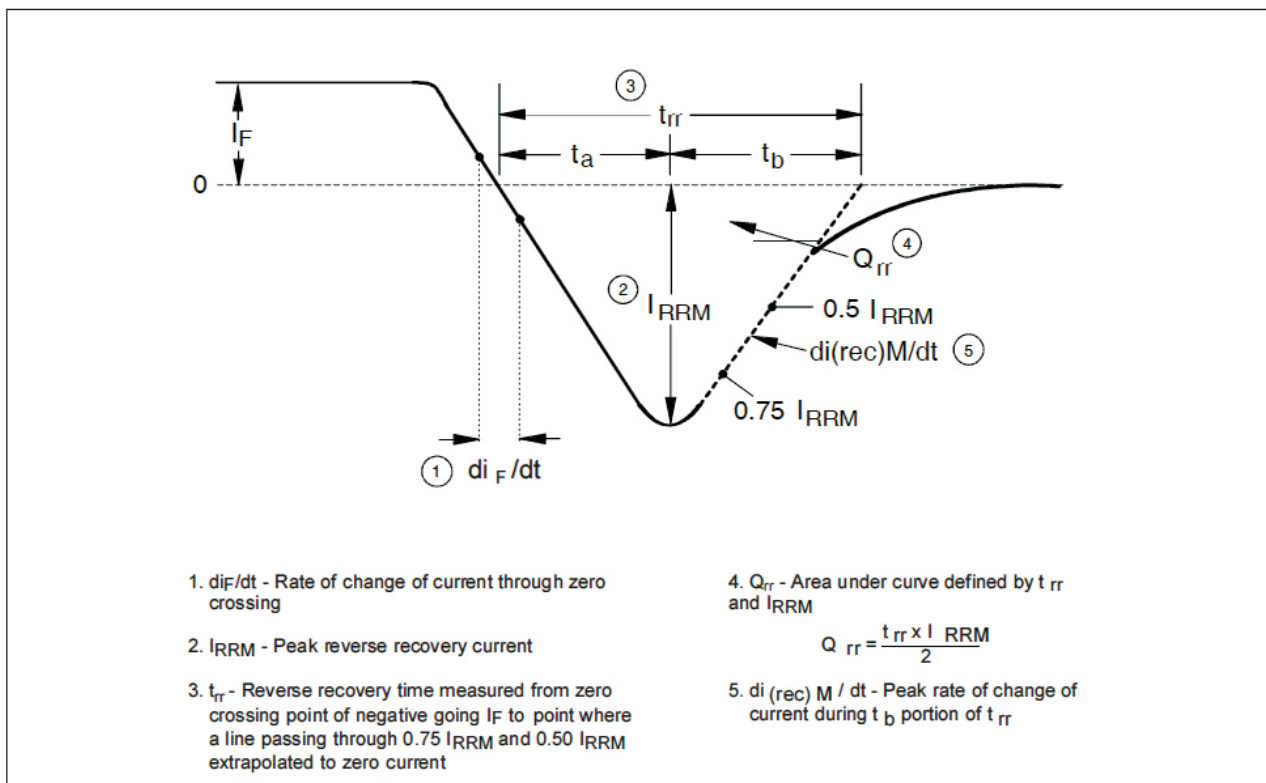
Fig.10 Reverse recovery waveform and definitions

Outline Table

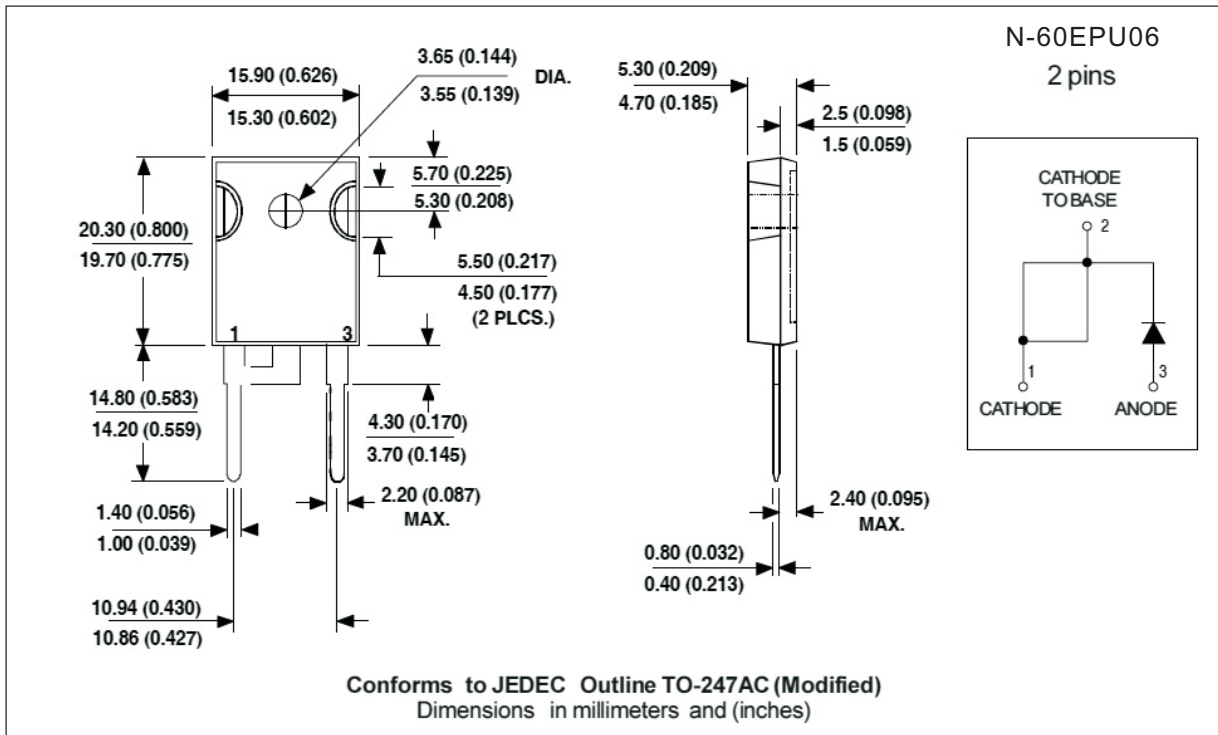

Outline Table

